



2475848114

Order no. P247 1138 13 Part no. 247 584 81 14
Edition B-2024



GLA, GLB

Mercedes-AMG Supplement

Mercedes-Benz



Publication details

Internet

Further information about Mercedes-Benz vehicles and Mercedes-Benz AG can be found on the following websites:

<https://www.mbusa.com> (USA only)

<https://www.mercedes-benz.ca> (Canada only)

Documentation team

©Mercedes-Benz AG: Not to be reprinted, translated or otherwise reproduced, in whole or in part, without written permission from Mercedes-Benz AG.

Vehicle manufacturer

Mercedes-Benz AG

Mercedesstraße 120

70372 Stuttgart

Germany

As at 09.02.23

Thank you for purchasing a Mercedes-AMG

Before your first drive, please read this Operator's Manual carefully and familiarize yourself with your vehicle. For your own safety and a longer service life of the vehicle, follow the instructions and warning notices in this Operator's Manual. Disregarding them may lead to damage to the vehicle or injury to people.

Damage to the vehicle resulting from the disregard of the instructions is not covered by the Mercedes-Benz Limited warranty.

The standard equipment and product description of your vehicle may vary and depends on the following factors:

- Model
- Order
- National version
- Availability

Your vehicle may therefore differ from that shown in the descriptions and illustrations in individual cases.

Mercedes-AMG reserves the right to introduce changes in the following areas:

- Design
- Equipment
- Technical features

The following documents are integral parts of the vehicle:

- Digital operator's manual
- Printed Operator's Manual
- Maintenance Booklet
- Supplementary manuals relating to specific equipment
- Supplementary documents

Keep these documents in the vehicle at all times. Ensure that all documents are in the vehicle or passed on in the event of sale or rental.

Mercedes-Benz USA, LLC

Mercedes-Benz Canada, Inc.

A Mercedes-Benz Group AG Company

2475848114





Symbols	3	Driver's display	21	Index	43
At a glance	4	Notes on the driver's display	21		
Cockpit	4	Operating the driver display	21		
General notes	6	Driver display menus	22		
Operator's Manual	6	Function of the head-up display	27		
Occupant safety	7	Overview of status indicators on the driver display (Mercedes-AMG vehicles)	28		
Seat belts	7	MBUX multimedia system	29		
Airbags	7	AMG TRACK PACE	29		
Seats	8	Maintenance and care	34		
Switching the seat ventilation of the AMG Performance seats on or off	8	Notes on the care of tailpipes	34		
Driving and parking	9	Technical data	35		
Driving	9	Operating fluids	35		
DYNAMIC SELECT	11	Vehicle data	37		
Automatic transmission	14	Display messages and warning/indicator lamps	39		
Driving and driving safety systems	15	Display messages	39		
		Warning and indicator lamps	40		

In this Operator's Manual, you will find the following symbols:

 **WARNING** Danger due to failure to observe the warning notices

Warning notices draw your attention to hazards that may endanger your health or life, or the health or life of others.

 Observe the warning notices.

 **ENVIRONMENTAL NOTE** Environmental damage due to failure to observe environmental notes

Environmental notes include information on environmentally responsible behavior or environmentally responsible disposal.

 Observe environmental notes.

 **NOTE** Damage to property due to failure to observe notes on material damage

Notes on material damage inform you of risks which may lead to your vehicle being damaged.

 Observe notes on material damage.

 These symbols indicate useful instructions or further information that could be helpful to you.

 Instruction

(→ page) Further information on a topic

Display Display in the central display

 Highest menu level, which is to be selected in the multimedia system

 Relevant submenus, which are to be selected in the multimedia system

* Indicates a cause

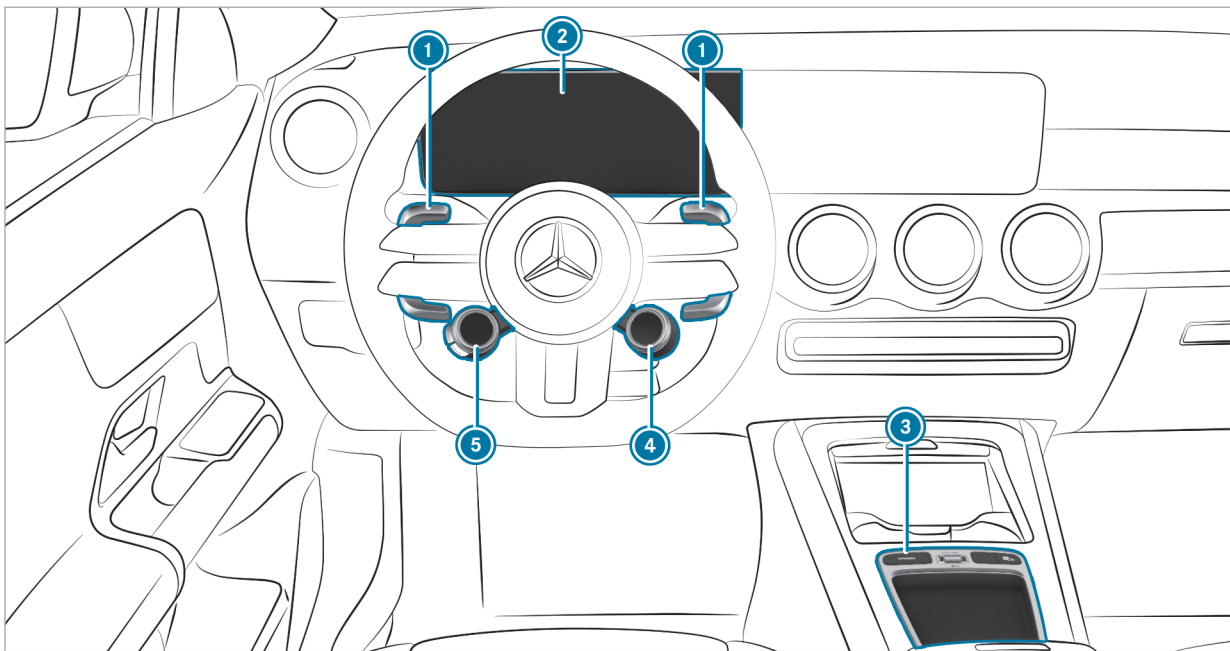

Left-hand drive vehicles

① Steering wheel paddle shifters	→	14
② Driver display	→	21
③ DYNAMIC SELECT button	→	11

④ Selecting the drive program	→	12
⑤ AMG steering-wheel buttons	→	9

Operator's Manual

These Operating Instructions provide information on all the important functions of your AMG vehicle that are either not described or differ from the descriptions in the Operator's Manual. This information supplements or replaces the corresponding sections in the vehicle Operator's Manual.

Under no circumstances do the Operating Instructions replace the printed vehicle Operator's Manual and the Digital Operator's Manual in the vehicle.

This Supplement and the Digital Operator's Manual in the vehicle describe the following models, standard and special equipment of your vehicle:

- Models, standard and special equipment available at the time of going to press with these Operating Instructions.
- The models and the standard and special equipment only available in certain countries.
- The models and the standard and special equipment, which will only be available at a later date.

Note that your vehicle may not be installed with all features described. This is also the case for systems relevant to safety. Therefore, the equipment on your vehicle may differ from that in the descriptions and illustrations.

The original purchase agreement for your vehicle contains a list of the equipment in your vehicle at the time of delivery.

Should you have any questions concerning equipment and operation, please consult an authorized Mercedes-Benz Center.

The Operator's Manual, Operating Instructions, further supplementary documents and Maintenance Booklet are important documents and should be kept in the vehicle.

Seat belts

Limitations of the protection provided by the seat belt

The AMG sports seat and the AMG Performance seat are designed for the standard three-point seat belt. If you install a different multipoint seat belt, for example a four-point seat belt, the restraint system cannot provide the intended level of protection.

Depending on the type of vehicle, there may be openings in the seat backrest. These openings have no function.

⚠ WARNING Risk of injury or fatal injury due to modified seat belt systems

If you feed seat belts through the opening in the seat backrest, the seat backrest may be damaged or may even break in the event of an accident.

- ▶ Only use the standard three-point seat belt.
- ▶ Never modify the seat belt system.

Airbags

Protection provided by the side airbag

Vehicles with AMG Performance seat: depending on the accident situation, the side airbag can increase the level of protection for the ribcage of the respective passenger in addition to a correctly fastened seat belt.

Switching the seat ventilation of the AMG Performance seats on or off

lamps are off, the seat ventilation is switched off.

Requirements:

- The power supply is switched on.

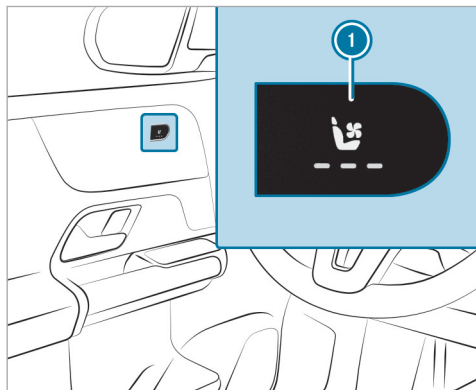

- ▶ Press button ① repeatedly until the desired blower setting has been reached. Depending on the blower setting, up to three indicator lamps will light up. If all indicator

Driving

Engine output and engine torque (Mercedes-AMG vehicles)

i The actual (maximum) values that can be achieved for engine output and engine torque may deviate from the certified values within the permissible tolerances according to country-specific guidelines (basis: UN-ECE No. 85 or country-specific guidelines).

Variables that can influence this are, for example:

- Location above sea level
- Fuel quality
- Outside temperature
- Operating temperature of the engine

Until the engine has reached its operating temperature, the engine operating temperature warning lamp  is lit.

Engine output and engine torque have been reduced. Take this into account in your driving style.

When the engine operating temperature warning lamp  goes out, full engine output and engine torque are available to you.



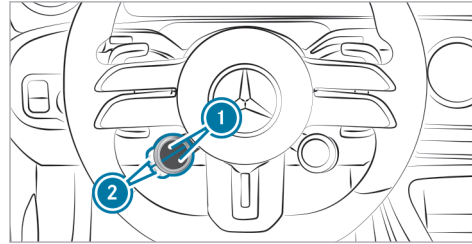



Function of the AMG steering-wheel buttons



The AMG steering-wheel buttons are two buttons on an additional control element on the steering wheel.

You can assign two vehicle functions of your choice to the control element. You can change between the available functions for corresponding button **2** by pressing the upper or lower part of display button **1** repeatedly. Display buttons **1** will show each function selected.

The following functions will be available depending on equipment:

-  ESP® (→ page 15)
-  AMG RIDE CONTROL (→ page 19)
-  Manual shifting (→ page 14)
-  ECO start/stop function (→ page 10)
-  AMG Real Performance Sound (→ page 10)
-  Camera perspectives (see vehicle Operator's Manual)
-  AMG DYNAMICS (→ page 11)

You can also select all functions that you have set as favorites in the multimedia system. Information on favorites in the multimedia system and their configuration (see vehicle Operator's Manual).

i Some functions can be hidden. How functions are displayed and the order in which they are displayed can be set in the multimedia system (→ page 10).

If you have assigned a function to one of display buttons **1**, you can operate this function with corresponding button **2**.

The assignment of display buttons ❶ will remain stored even after the vehicle has been started again. The operating status of the respective function will, however, be reset to the basic setting.

Setting the AMG steering wheel buttons

Multimedia system:

- ➔  ➔ Settings ➔ System
- ➔ Control Elements
- ➔ AMG Steer. Wheel Buttons

The left display buttons on the steering wheel can be set in the **SETTINGS SELECT** menu.

- ▶ Press **+** and select the desired function from the list.
The selected function is assigned to the corresponding display button and can now be called up directly by simply pressing it.

Deleting button assignment

- ▶ Select the upper or lower display button and switch to editing mode by pressing and holding it.

- ▶ Press  to delete the selected display button assignment.

Switching the ECO start/stop function on or off using the steering wheel button (Mercedes-AMG vehicles)

Observe the notes on the ECO start/stop function in the vehicle Operator's Manual.

- ❶ You can also switch the ECO start/stop function on or off via the multimedia system.

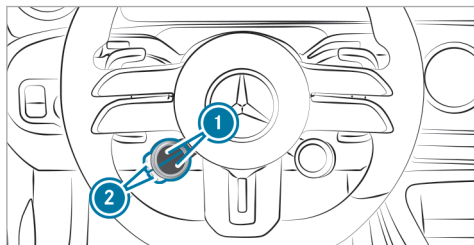



- ▶ Press the upper or lower ❶ display button repeatedly, until it displays the  symbol.

- ❶ If the display button does not show the symbol, then it is hidden. How functions are displayed and the order in which they are displayed can be set in the multimedia system (→ page 10).

- ▶ Press corresponding button ❷.

The symbol indicates the current status of the ECO start/stop function:

-  (red): deactivated
-  (green): activated
-  (yellow): inactive

AMG Real Performance Sound

Selecting a sound characteristic with the steering-wheel button

- ❶ You can select a comfortable (Balanced) or a sporty (Powerful) sound characteristic using the steering-wheel button or the multimedia system (→ page 13).

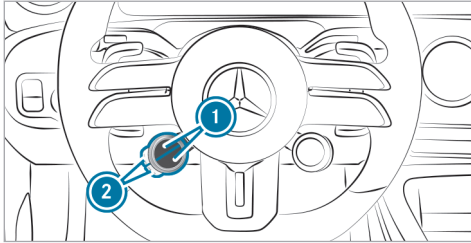

▶ Press upper or lower display button ① repeatedly, until it displays the  symbol.

① If the display button does not show the symbol, then it is hidden. How functions are displayed and the order in which they are displayed can be set in the multimedia system (→ page 10).

▶ Press corresponding button ②.

The color of the button symbol indicates the currently selected sound characteristic:

- **Blue:** Balanced – comfortable
- **Red:** Powerful – sporty





DYNAMIC SELECT

Function of DYNAMIC SELECT (Mercedes-AMG vehicles)

DYNAMIC SELECT makes the quick selection of a drive program possible in accordance with the current driving situation or the desired vehicle characteristics.

① Depending on the engine and equipment, the vehicle has different drive programs.

You can select from the following drive programs:

-  **Slippery**
 - Optimized pulling away and driving characteristics in wintry and slippery road conditions
-  **Comfort**
 - Comfortable and economical driving
-  **Individual**
 - Customized settings for drive, suspension, steering and ESP®
-  **Sport**
 - Sporty driving

- Balance between stability and sportiness
- Only suitable for good road conditions, a dry road surface and a clear stretch of road



-  **Sport+**

- Particularly sporty driving
- Only suitable for good road conditions, a dry road surface and a clear stretch of road

-  **Race**

- Maximum sportiness
- Particularly firm suspension tuning of AMG RIDE CONTROL
- Sporty sound from the exhaust system

① Drive program  is available only for the **Mercedes-AMG GLA 45 S 4MATIC+** model.

Drive program  offers driving characteristics suited for the racetrack and must not be used on normal roads. Drive program  may be activated and used only on dedicated race circuits, not on public roads.

12 Driving and parking

Mercedes-AMG recommends selecting drive program **[C]** when in city traffic or stop-and-go traffic.

Depending on the drive program selected, the following vehicle characteristics will change:

- Drive
- AMG DYNAMICS
 - The four agility functions, Basic, Advanced, Pro and Master, will be selected automatically depending on the drive program.
 - The steering, shift timing point, all-wheel drive and stabilization functions will be adapted to the selected drive program.
 - When ESP® is activated, the Pro agility function will be selected in drive program **[ESP SPORT]**. When ESP® is activated **[ESP SPORT]** or deactivated **[ESP OFF]** in SPORT, the Master function is selected automatically.
- Real Performance Sound
- Suspension
- Steering
- Availability of Glide mode

- 4MATIC+

- i** You can set the drive program characteristics using the multimedia system (→ page 13).
- i** You can adjust certain agility functions of AMG DYNAMICS using the AMG steering wheel buttons.

Selecting a drive program (Mercedes-AMG vehicles)

Selection with right-hand steering-wheel button

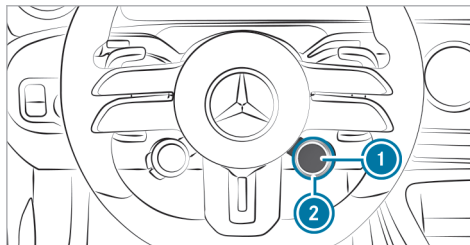

- ▶ Turn rotary switch **2**.

The selected drive program will appear on display button **1** and on the driver's display.

- i** Individual drive programs may not be shown. How drive programs are displayed and the order in which they are displayed can be set in the multimedia system (→ page 13).

- ▶ **To set drive program properties:** press display button **1**.

Selection via the central display (multimedia system)

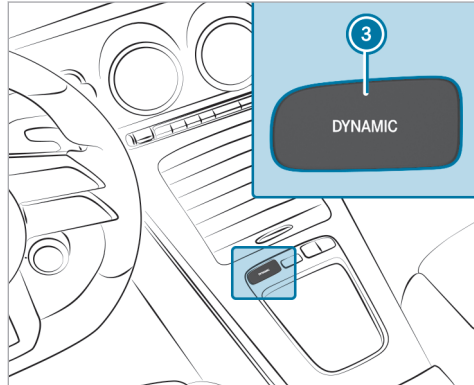

- ▶ Press DYNAMIC SELECT button ③ and select the drive program via the central display and set its properties (→ page 13).

Setting AMG DYNAMIC SELECT in the MBUX multimedia system

Multimedia system:

- ▶ Settings ▶ Vehicle
- ▶▶ DYNAMIC SELECT

Overview of the AMG DYNAMIC SELECT menu

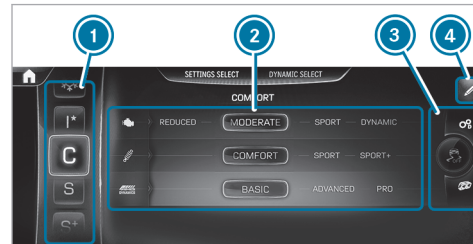

(Example of representation) Representation and arrangement of content equipment-dependent.

- ① Drive programs
- ② AMG drive program settings

- ③ ESP and quick-access buttons® (→ page 15)
- ④ Edits the quick-access buttons

ⓘ The AMG **DYNAMIC SELECT** menu can also be called up using the **DYNAMIC SELECT** button.

- ▶ Select the appropriate drive program.

The settings of the drive programs can be adjusted individually.

- ▶ Select the desired tab on the left and make the relevant setting.

Setting options for the drive programs (equipment-dependent):

- AMG DYNAMICS:
Basic/Advanced/Pro/Master
- Suspension:
Comfort/Sport/Sport+
- Sound:
Balanced/Powerful
- Drive (can only be set in the drive program):

Reduced/Moderate/Sport/Dynamic

Automatic transmission

Rocking the vehicle free

Rocking the vehicle free may help to free the vehicle if it has become stuck in slush or snow.

To rock the vehicle free, move the DIRECT SELECT lever upwards and downwards past the point of resistance to switch between transmission positions **D** and **R**.

- ① The maximum design speed for switching between **D** and **R** is approx. 6 mph (9 km/h).

Manual shifting (Mercedes-AMG vehicles)

- ① You can also activate and deactivate manual gearshifting via the multimedia system (→ page 15).

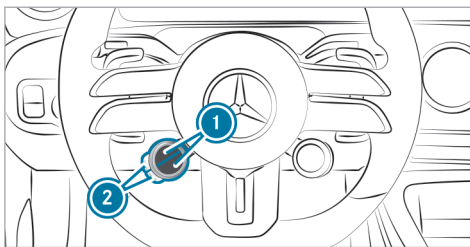

- ▶ Press upper or lower display button ① repeatedly, until it displays the symbol.

- ① If the display button does not show the symbol, then it is hidden. How functions are displayed and the order in which they are displayed can be set in the multimedia system (→ page 10).

- ▶ **To activate/deactivate:** press corresponding button ②.

The symbol indicates the currently selected transmission position:

- **M** (red): manual gearshifting
- **D** (blue): automatic transmission

Shifting up and down

- ! **NOTE** Damage to the engine due to shifting up too late

The automatic transmission does not shift up in manual mode even when the engine's limiting speed is reached.

The fuel supply is interrupted in order to prevent the engine from overrevving.

- ▶ Shift up before the engine speed reaches the red area in the tachometer.

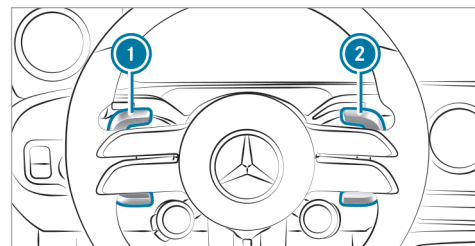

- ▶ **To shift up:** pull steering wheel paddle shifter ②.

- ▶ **To shift down:** pull steering wheel paddle shifter ❶.

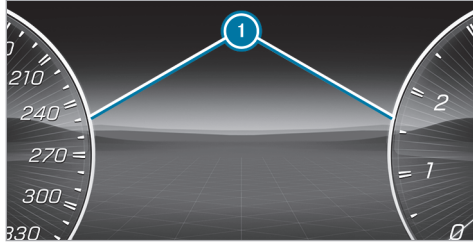

If the engine speed is too high or too low, you will not be able to change gear using the steering wheel paddle shifters. In this case, segments ❶ will light up red in the driver's display.

Permanently activating or deactivating manual gearshifting

Multimedia system:

▶  ▶ Settings ▶ Vehicle ▶ Driving

- ▶ Permanently switch the function on or off.

Function of Glide mode (Mercedes-AMG vehicles)

With an anticipatory driving style, Glide mode helps you to reduce fuel consumption.

When you drive in Glide mode, the  symbol will appear on the driver's display and, depending on the model, the combustion engine is switched off or decoupled from the drive train. All of the vehicle functions remain active.

Glide mode will be activated if the following conditions are met:

- The ECO start/stop function is switched on.
- Drive program  is selected with the drive setting "Moderate" or "Reduced".
- The speed is within a suitable range.
- The road's course is suitable, e.g. no steep uphill or downhill gradients or tight bends.
- The state of charge of the battery is sufficient.
- You are no longer depressing the accelerator or brake pedal.

Glide mode will be deactivated again if one of the conditions is no longer met.

Driving and driving safety systems

Function of ESP® (Mercedes-AMG vehicles)

You can choose between the following modes of the Electronic Stability Program (ESP®):

- ESP® ON
- ESP® SPORT
- ESP® OFF

Characteristics when ESP® is activated

ESP® monitors and improves driving stability and traction, particularly in the following situations:

- When you pull away on wet or slippery road surfaces.
- When you brake.
- When there is a strong crosswind and the vehicle's speed is between approximately 50 mph (80 km/h) and 125 mph (200 km/h)

ESP® can stabilize the vehicle by intervening in the following ways:

- Applying the brakes to one or more wheels

- Adapting the engine output according to the situation

ESP® will be activated every time the vehicle is started, regardless of whether ESP® SPORT or ESP® OFF was selected before the vehicle was switched off.

When the  warning lamp flashes, one or more wheels have reached their grip limit:



- Adapt your driving style to suit the prevailing road and weather conditions.
- Do not deactivate ESP® under any circumstances.
- Depress the accelerator pedal only as far as necessary when pulling away.

Characteristics of ESP® SPORT

⚠ WARNING Risk of skidding if ESP® SPORT is used incorrectly

When you activate ESP® SPORT, there is an increased risk of skidding and having an accident.

▶ Activate ESP® SPORT only in the circumstances described below.

When ESP® SPORT is selected, the  and  warning lamps will light up continuously.

Select ESP® SPORT when the vehicle's own oversteer and understeer characteristics are desired, e.g. on cordoned-off roads.

Driving with ESP® SPORT or with ESP® deactivated requires an extremely skilled and experienced driver.

If ESP® SPORT is activated and one or more wheels start to spin, the  warning lamp will flash. ESP® then only stabilizes the vehicle to a limited degree.

ESP® SPORT also has the following characteristics:

- ESP® only improves driving stability to a limited degree.
- ETS/4ETS traction control is still active.
- The engine's torque is only restricted to a limited degree and the drive wheels can spin.

The spinning of the wheels results in a cutting action for better traction on loose surfaces.



- ESP® continues to provide assistance when the brakes are firmly applied.
- Crosswind Assist is no longer active.

Characteristics when ESP® is deactivated

⚠ WARNING Risk of skidding if ESP® is deactivated

If you deactivate ESP®, ESP® cannot carry out vehicle stabilization.

▶ ESP® should only be deactivated in the following situations.

When ESP® is deactivated, the  and  warning lamps will light up continuously.

Deactivating ESP® has the following effects:

- Driving stability will no longer be improved.
- The drive wheels could spin.
- ETS/4ETS traction control will still be active.
- Crosswind Assist will no longer be active.

- ❗ Even when ESP® is deactivated, you will still be assisted by ESP® when braking hard.

It may be best to activate ESP® SPORT or deactivate ESP® in the following situations:

- When using snow chains.
 - In deep snow.
 - On sand or gravel.
- ❗ Spinning the wheels will cause them to dig in to the surface, thereby enhancing traction.
 - ❗ Activate ESP® as soon as the situations described above no longer apply. ESP® will otherwise not be able to stabilize the vehicle if the vehicle starts to skid or a wheel starts to spin.

If the  warning lamp lights up continuously, ESP® is not available due to a malfunction.

Observe the display messages and warning and indicator lamps that are shown.

- Warning and indicator lamps
- Display messages

ETS/4ETS (Electronic Traction System)

ETS/4ETS traction control is part of ESP®.



ETS/4ETS can improve the vehicle's traction by intervening in the following ways:

- The brakes will be applied to the drive wheels individually if they spin.
- More drive torque will be transferred to the wheel or wheels with traction.

Setting ESP® with the steering-wheel button

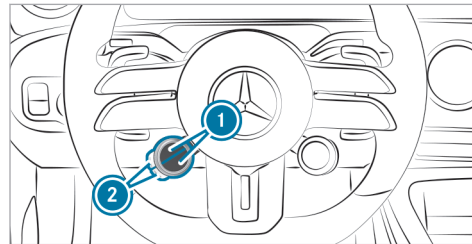

- ❗ You can also adjust ESP® via the multimedia system (→ page 18).



- ▶ **To set ESP®:** press upper or lower display button  repeatedly, until it displays the  symbol.



- ❗ If the display button does not show the symbol, then it is hidden. How functions are displayed and the order in which they are displayed can be set in the multimedia system (→ page 10).

The color of the road in the  button symbol indicates the current setting:

-  (blue): ESP® ON
-  (yellow): ESP® SPORT
-  (red): ESP® OFF



- ▶ **To set ESP® SPORT:** briefly press button  when ESP® is activated.

The road in the  button symbol will light up yellow.

The  and  warning lamps will appear on the driver's display.

- ▶ **To deactivate ESP®:** select ESP® SPORT and then press and hold button ②.

The road in the  button symbol will light up red.

The  and  warning lamps will appear on the driver's display.

- ① When you deactivate  ESP® in drive program , AMG Dynamics will automatically switch to the **Master** level.

- ▶ **To activate ESP®:** briefly press button ② when ESP® SPORT is selected or ESP® is deactivated.

The road in the  button symbol will light up blue.

The ,  or  warning lamps will go out.







If the  symbol is shown with a red ! on the display button, ESP® is malfunctioning. Observe the information on warning lamps and display messages which are shown on the driver's display.



Setting ESP® in the multimedia system

Multimedia system:

- ▶  ▶ Settings ▶ Vehicle
- ▶ **DYNAMIC SELECT**

ESP will always be activated when the vehicle is started. The road in the  button symbol lights up blue.

- ▶ **To set ESP SPORT:** when ESP is activated, briefly press  to change to the **Sport** program.
The road in the  button symbol lights up yellow.
- ▶ **To deactivate ESP:** set the ESP SPORT program and press and hold  to deactivate ESP.
The road in the  button symbol lights up red. The  and  warning lamps appear on the driver's display.
- ▶ **To activate ESP:** briefly press  in ESP SPORT or if ESP is deactivated.
The road in the  button symbol lights up blue.

The ,  or  warning lamps go out.

- ① You can also set ESP via the steering-wheel buttons (→ page 17).

RACE START

Information about RACE START

RACE START enables optimal vehicle acceleration from a standstill. A suitably high-grip road surface is required for this, and the tires and vehicle must also be in good condition.

RACE START is only available after the vehicle has been run in.

- ① RACE START must not be used in normal road operation. RACE START may be activated and used only on dedicated race circuits, not on public roads.
Read the safety notes and information on ESP® (→ page 15).



⚠ WARNING Risk of skidding and having an accident from wheels spinning

If you use RACE START, depending on the ESP® mode selected, there is an increased risk of skidding and having an accident.

- ▶ Make sure that no persons or obstacles are in the close vicinity of your vehicle.

■ Activating RACE START

Requirements

- The driver's door is closed.
- The engine is running and the transmission and engine are at normal operating temperature.
- The steering wheel is in the straight-ahead position.
- The vehicle is on level ground.
- The vehicle is stationary, the brake pedal is depressed (left foot) and the parking brake is released.
- One of drive programs ,  or  is selected (→ page 11).

▶ Rapidly depress the accelerator pedal fully. The engine speed will increase. The **RACE START Release brake to start** message appears in the driver's display.

ⓘ **Mercedes-AMG GLA 45 S 4MATIC+:** in this phase, you can adjust RACE START depending on the road conditions; you can vary the engine speed by pulling on one of the steering wheel paddle shifters. The segments in the driver's display flicker rapidly.

ⓘ If the brake pedal is not released after a short while, RACE START will be canceled. The **RACE START Canceled** message appears in the driver's display.

▶ Take your foot off the brake, but keep the accelerator pedal depressed. The vehicle will pull away at maximum acceleration. The **RACE START Active** message appears in the driver's display.

RACE START will be deactivated immediately if you release the accelerator pedal during RACE START or if any of the activation conditions are no longer fulfilled. The **RACE START Canceled** message appears in the driver's display.

ⓘ After using it several times in quick succession, RACE START will be unavailable until a certain distance has been driven.

AMG adaptive sport suspension system

■ Function of AMG RIDE CONTROL

AMG RIDE CONTROL is an electronically controlled damping system for improved driving comfort and increased driving safety.

The damping is adjusted individually to each wheel and depends on the following factors:

- driving style, e.g. sporty
- road condition, e.g. bumps
- The individual selection of **SPORT**, **SPORT +** or **COMFORT**

The suspension setting depends on the drive program selected.

In addition, you can select the setting in every drive program individually using the AMG steering wheel button (→ page 20). After a drive program is changed, the automatic suspension setting of the drive program is reactivated.

- When the vehicle is started again, the **COMFORT** setting is activated automatically.

Selecting the suspension setting

- You can also adjust the suspension setting via the multimedia system (→ page 13).

You can select from three different suspension settings:

- **COMFORT** ensures a comfortable suspension setting. Select this suspension setting if you prefer a comfortable driving style.
- **SPORT** ensures a firmer suspension setting. Select this suspension setting when employing a sporty driving style, e.g. on winding country roads.
- **SPORT +** ensures a very firm suspension setting.

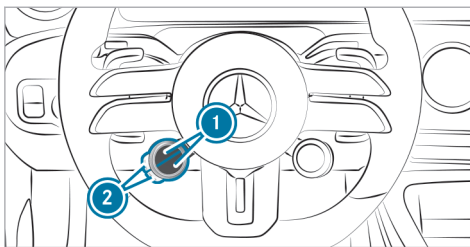



▶ Press the upper or lower ① display button repeatedly, until it displays the  symbol.

- If the display button does not show the symbol, then it is hidden. How functions are displayed and the order in which they are displayed can be set in the multimedia system (→ page 10).

▶ Press corresponding button ②.
The selected suspension setting is shown in the driver's display as a message.

The  symbol indicates the currently selected mode:

-  (blue): COMFORT

-  (yellow): SPORT
-  (red): SPORT +

Notes on the driver's display

⚠ WARNING Risk of accident if the driver's display fails

If the driver's display fails or malfunctions, you may not be aware of any functional limitations to safety-critical systems. This may affect the operating safety of the vehicle.

- ▶ Park the vehicle safely as soon as possible and notify a qualified specialist workshop.

The driver's display shows the following basic information:

- Speed, engine speed and power meter level
- Range on map
- Indicator and warning lamps

Additional functions available include the following:

- Various menus, such as Classic
- Status displays for the driving systems
- Display messages

Operating the driver display

⚠ WARNING Risk of distraction from information systems and communications equipment

If you operate information systems and communication devices integrated in the vehicle when driving, you could be distracted from the traffic situation. This could also cause you to lose control of the vehicle.

- ▶ Only operate this equipment when the traffic situation permits.
- ▶ If you cannot be sure of this, stop the vehicle whilst paying attention to road and traffic conditions and operate the equipment with the vehicle stationary.

Observe the legal requirements for the country in which you are currently driving when operating the driver display.

Scrolling through the menu bar and calling up a menu

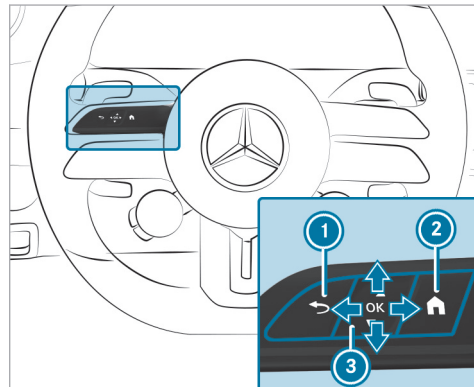

- ① Back button
- ② Main menu
- ③ Touch Control

The content on the driver display is controlled using the control elements on the left side of the steering wheel. Touch Control ③ is used to navi-

gate in a vertical and horizontal direction by swiping with one finger. Confirm the selection by pressing the Touch Control.

i To operate Touch Control **3** in the most effective way, use the tip of your thumb if possible. You can also set the sensitivity of the Touch Control on the central display.

▶ Briefly press main menu button **2**.

▶ Select a menu by swiping to the left or right on Touch Control **3**.

▶ **To confirm:** press Touch Control **3**.

Calling up or exiting the **Options** submenu

▶ **To call up:** press left-hand Touch Control **3**.

▶ **To exit:** press back button **1**.

Browsing through display content or lists

▶ Swipe up, down, left or right on left-hand Touch Control **3**.

i For different menus, icons appear at the right edge of the center display section to indicate the current position in a list.

Setting display content as the standard display

You can set custom-configured menu display content as the standard display.

▶ Press and hold left-hand Touch Control **3** until the bar display that appears is completely filled.

The **Set Shortcut?** prompt will appear.

▶ Swipe left on left-hand Touch Control **3** and select **Yes**.

▶ **To confirm:** press the left-hand Touch Control **3**.

▶ **To call up standard displays:** press back button **1** on the upper level of a menu.

i Pressing back button **1** on the standard display will call up the previous menu.

Resetting values

▶ **To call up the Options submenu:** press left-hand Touch Control **3**.

▶ **To select the function to be reset:** press left-hand Touch Control **3**.

▶ Select **Yes**.

▶ **To confirm:** press the left-hand Touch Control **3**.

Driver display menu

Configuring settings on the **Classic** or **Understated** menus (Mercedes-AMG vehicles)

Driver's display:

↳ **Classic**

Selecting display content in the center display area of the **Classic** menu

▶ Call up the **Classic** menu via the driver's display menu bar.

▶ **To select display content:** swipe upwards or downwards on the left-hand Touch Control and select the desired display content.

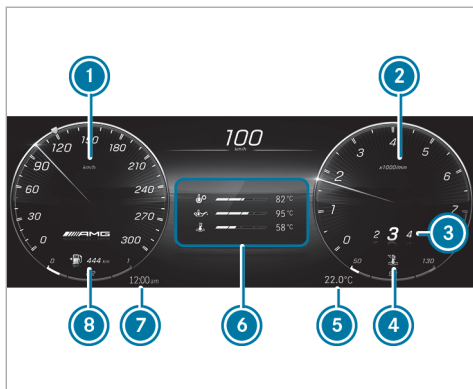

- ① Speedometer
- ② Tachometer
- ③ Gear display
- ④ Coolant temperature display
- ⑤ Outside temperature
- ⑥ Display content, center on the **Classic** menu (example: temperature)

- ⑦ Time
- ⑧ Fuel level and fuel filler flap location indicator

The following display content of the **Classic** menu can be shown in center display area ⑥:

- Trip and total distance
 - Trip computer **From Start** and **From Reset**
 - ECO display
 - Consumption
 - ATTENTION ASSIST
 - Audio
 - Navigation
 - Temperature (transmission oil, engine oil and coolant)
 - Setup
 - Engine data
- ① Depending on the vehicle equipment, AMG-specific content regarding temperature, setup and engine data will be displayed. The settings for the setup display content can be configured either via the buttons on the multi-

function steering wheel or via the MBUX multimedia system (→ page 13).

Selecting the radio station or track on the station or track list

You can select radio stations or tracks on the station or track list in the audio display content of the **Classic** menu.

The following adjustments can be made in the MBUX multimedia system:

- Configuring the station or track list
- Switching between media sources
- Setting the frequency band

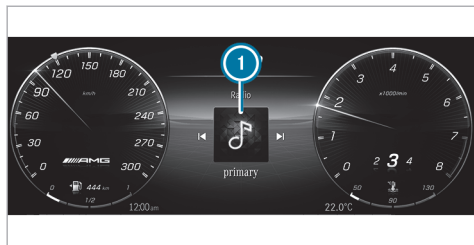

- ① Track list for the audio display content in the center display area (example)
- ▶ **To change radio stations or tracks:** swipe left or right on the left-hand Touch Control and select a radio station or track on station or track list ①.
- ① If you do not carry out any operations immediately after opening station or track list ①, the view will return to the radio station or track selected.
- ① The radio station or title displayed when the vehicle is restarted depends on the user profile used for the previous trip.

Calling up or exiting the **Options** submenu on the **Classic** menu

Depending on the selected display content, you can make changes in the center display area on the **Options** submenu.

- ▶ **To call up the Options submenu:** press the left-hand Touch Control.
- ▶ **To exit the Options submenu:** press the back button .

The following functions may be available on the **Options** submenu, for example:

- Navigation: selecting and adjusting zoom, route guidance and map settings
- Resetting trip distance
- Resetting the trip computer **From Start**
- Resetting the trip computer **From Reset**
- Resetting the ECO display values

Changing color settings on the **Understated** menu

- ▶ Call up the **Understated** menu via the driver's display menu bar.

- ▶ **To call up the color list:** press the left-hand Touch Control.

The color list on the **Understated** menu will appear.

- ▶ **To select color settings:** swipe upwards or downwards on the left-hand Touch Control and select the desired color setting.

- ① If you do not carry out any operations within a limited time after opening the color list, the view will switch back to the default view of the **Understated** menu.

- ▶ **To exit the color list:** press the  back button.

- ① Depending on the equipment, the selected color setting will be adopted for the ambient lighting and the MBUX multimedia system. If you select the **Understated** menu on the driver's display, the content in the MBUX multimedia system will also be made smaller.

Configuring settings on the Supersport menu

Driver's display:

↳ Supersport

- ▶ **To select display content:** swipe upwards or downwards on the left-hand Touch Control.

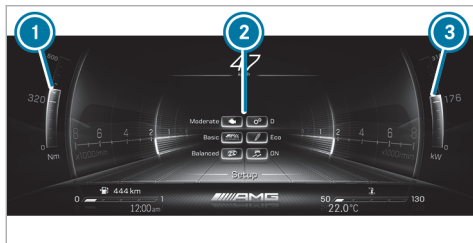

- ① Current torque
- ② Center display content (example: setup)
- ③ Current power output
- i The displays for current torque ① and current power ③ vary depending on the display content in the center display area.

Center display section ② of the Supersport menu shows the following display contents:

- Gear display
- Temperature display (transmission oil, engine oil, coolant)
- Engine data
- Setup
- G-force
- Trip and total distance
- Distance **From Start** and **From Reset**
- Consumption
- Audio
- Navigation
- i Depending on the vehicle equipment, AMG-specific content regarding temperature, setup and engine data will be displayed. The settings for the setup display content can be configured either via the buttons on the multi-function steering wheel or via the MBUX multimedia system (→ page 13).

Calling up the Track Pace menu

Driver display:

↳ TRACK PACE

The Track Pace function is intended for use on designated race tracks. Do not use this function on public roads, and adapt your driving style to your personal capabilities and the ambient conditions.

The following options will be displayed on the **TRACK PACE** menu:

- G-meter
- Race track selected
- Braking and acceleration procedure
- Gear currently selected



Displays on the Track Pace menu (example)

- ① G-meter
- ② Center display content (example: gear display)
- ③ Telemetry display (example: selected race track)

▶ **To call up the menu:** press the left-hand Touch Control.

The display content of the **TRACK PACE** menu will adapt to the selected settings on the central display:

- Gear display
- Braking points
- Acceleration

- Quarter-miles
- Race track selected on the central display
- Current race
- Record route

While the vehicle is in motion, the G-meter shows the forces that are exerted on the vehicle occupants both laterally and in the direction of travel. The maximum values appear in red in the coordinate system.

Calling up displays on the Sport menu

Driver display:

➔ Sport

The **Sport** menu displays information about the engine data, the setup and the temperature of the vehicle.

▶ **To call up the menu:** swipe to the left or right on the left-hand Touch Control.

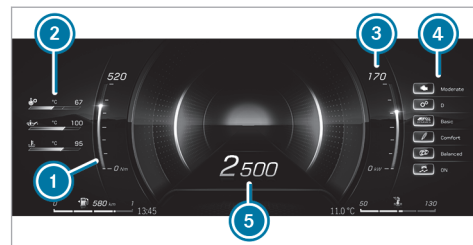

- ① Current torque
- ② Temperature (transmission oil temperature, engine oil temperature, coolant temperature)
- ③ Current power output
- ④ Setup (drive position, transmission position, AMG DYNAMICS, suspension tuning, exhaust system, ESP®)
- ⑤ engine speed

i Depending on the vehicle equipment, AMG-specific content regarding temperature, setup and engine data will be displayed. The settings for the setup display content can be configured either via the buttons on the multifunction steering wheel or via the MBUX multimedia system (→ page 13). You can also activate or deactivate ESP® using the steering-wheel button or via the MBUX multimedia system.

Function of the head-up display

The head-up display projects various content into the driver's field of vision, for example.



You can use the head-up display menu bar to select various contexts, e.g.:

- **Supersport**
- **TRACK PACE**
- Minimal
- Race
- Standard
- ECO display (depending on model and equipment)
- Settings
- Head-up display on/off

Head-up display content with navigation (6x2°)

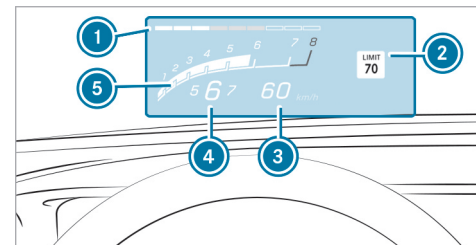

- ① Protection from reaching the overrewing range
- ② Detected instructions and traffic signs
- ③ Current speed
- ④ Currently selected gear; gearshift options for manual shifting
- ⑤ Current engine speed

System limits

Visibility is particularly influenced by the following conditions:

- Seat position



- Image position setting
- Ambient light
- Wet road surfaces
- Objects on the display cover
- Polarization in sunglasses

Overview of status indicators on the driver display (Mercedes-AMG vehicles)

The status indicators for the driving and driving safety systems can be found in display sections

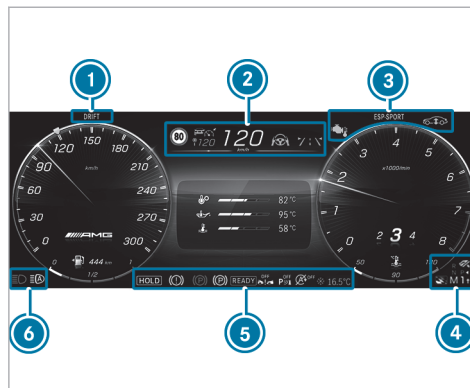
① to ⑥.



-  HOLD function
-  Slippery road surface warning
-  Engine operating temperature warning lamp (→ page 9)

i The number, position and presentation of the status indicators on the driver display depend on which systems are activated or deactivated.

Depending on the vehicle equipment, Mercedes-AMG vehicles may have the following status indicators:

-  Pedestrian detection (on assistant display only)

AMG TRACK PACE

Function of AMG TRACK PACE

i This function is an on-demand feature and can be activated via Mercedes me after you purchase your vehicle. The Digital Operator's Manual contains further information on Mercedes me and on-demand features.

With AMG TRACK PACE, the driving characteristics on race tracks can be analyzed and optimized. You can drive previously saved race tracks (e.g. Hockenheimring), or record and save new tracks. The driven lap times are stored for every track. These can be analyzed and compared with other lap times to achieve the best possible race results. Additionally, acceleration and braking procedures can be measured and stored.



Note: Use AMG TRACK PACE only on closed-off routes away from public roads. Adapt your driving style to your personal performance and environmental conditions. As the driver, you are solely responsible for driving your vehicle. Park your vehicle safely before operating the application.

Setting Track Race



Multimedia system:

↳ TRACK PACE ▶▶ Track Race

Recording a new track

- ▶ Select  **New Track** .
- ▶ Select  **Start Record**. at the desired starting point.
Track recording will start at this point.

During track recording, sectors can be set to divide up the track.

- ▶  Select **Set Sector**.
- ▶ Select  **Stop Recording** to end track recording or cross the start line again.
- ▶ Confirm the prompt with **Yes**.
- ▶ Select the weather.

i The temperature will be determined automatically.



- ▶ Enter a name.

- ▶ Press **OK** to confirm.
The track will be saved under the name entered.

Searching by track name

- ▶ Select  **Search**.
- ▶ Enter the track name.
Tracks with the name that you have searched for will be displayed.



Measuring time on a saved track

- ▶  Select **All tracks**.
- ▶ Select the desired track.
- ▶ Select .
- ▶ Select **Start Time Recording** if you are already at the start line.

or

- ▶ Select **Navigate to** to navigate to the start line.

Timing will begin automatically when you cross the start line.



- ▶ **i** When  is selected, the track display can be switched to AR. In addition, it is possible to switch to the telemetry display by selecting .

- ▶ Select  **Stop timing** to end timekeeping.
- ▶ Confirm the prompt with **OK**.
- ▶ Select the weather.
- ▶ Select **Yes** to save the times set for this track.

Showing readings during Track Race

The following readings can be shown:

- Tire temperature
- Miniature map
- Sector overview
- Engine data
- G-force display
- Lap overview

- ▶ Select  **Start Time Recording**.
- ▶ Select .

- ▶ Pull the desired display from the grid on the left or right edge of the media display. The readings will be shown during Track Race.

You can deactivate this by selecting  on the active display.

Displaying the analysis

- ▶  Select **All tracks**. An overview of all the tracks you have driven will appear.
- ▶ Select a track.
- ▶ Select a session.

The following data will be displayed:

- Lap and sector times
- Average and top speed
- Driver
- Vehicle
- Date
- Weather
- ▶ Select **Add Recording** to use a different session as a reference value.
- ▶ Select  to return to the overview.

- ▶ Select **Diagram**.
- ▶ Set the desired parameters. The analysis will be displayed.

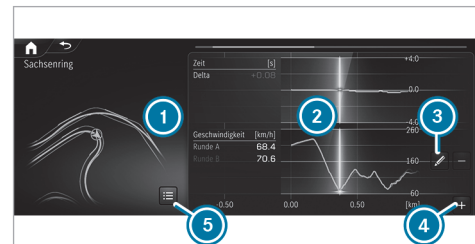



- ① Lap overview
- ② Parameter overview
- ③ Editing parameters
- ④ Adding new parameters
- ⑤ Deleting parameters

- i** The following values can be set for the parameters, for example:
 - Speed
 - Longitudinal/lateral acceleration



- Steering angle
- Engine speed
- Engine oil/tire temperature

Based on the analysis, you can check and optimize the driving behavior for any position on the track.

Exporting tracks (USB)

- ▶ Select  **Tracks** .
An overview of all stored tracks will appear.
- ▶ Select the desired track.
- ▶ Select options  for the desired track.
- ▶ Select **Export Track to...**
The selected track can be exported to a USB storage device connected to the vehicle.

Editing tracks and recordings

- ▶ Select  **Tracks** .
- ▶ Select the desired track.
- ▶ Select options  for the desired track.
- ▶ Select **Rename** or **Delete**.

or

- ▶ Select a track.
- ▶ Highlight the desired recording.
- ▶ Select  options.
- ▶ Select **Export to...** or **Delete**.

Setting Drag Race

Multimedia system:

 **TRACK PACE**  **Drag Race**

Measuring acceleration

- ▶ Select  **Drag Race options**.
- ▶ Select **Acceleration**.
- ▶ Set a starting speed or select **Automatic**.
Measurement begins as soon as the specified starting speed has been reached.
- ▶ Set a target speed.
Measurement stops as soon as the specified target speed has been reached.
- ▶ Start off and begin the measurement.
Measurement begins when the vehicle accelerates.

Measurement can be stopped early by interrupting the acceleration procedure.

Quarter mile race

- ▶ Select  **Drag Race options**.
- ▶ Select **Quarter Mile**.
- ▶ Set a target distance.
Measurement stops as soon as the specified target distance has been reached.
- ▶ Start off and begin the measurement.
Measurement begins when the vehicle accelerates. Timing runs until the target distance or a maximum of one mile has been covered.

Measurement can be stopped early by interrupting the acceleration procedure.

Measuring braking

- ▶  **Drag Race options**
- ▶ Select **Braking**.
- ▶ Set a starting speed or select **Automatic**.
- ▶ Start off and begin the measurement.

- ▶ Brake to a standstill. Measurement is incremental, in steps of 6 mph (10 km/h) to a standstill. If the braking procedure is started e.g. at a speed of 98 mph (157 km/h), measurement starts as soon as 93 mph (150 km/h) has been reached.

Storing and calling up measured values

If measurement is completed or canceled, a prompt appears asking whether the measurement should be saved.

- ▶ Confirm the prompt with **OK** to save.

Calling up saved measurements

- ▶ Select  **History**.
- ▶ Select **Acceleration**, **Quarter Mile** or **Braking**.
- ▶ Select a measurement. The desired measurement is displayed in detail.

or

- ▶ Delete a measurement.

Calling up the telemetry display

Multimedia system:

- ▶  **TRACK PACE** ▶▶ **Telemetry**

The telemetry display shows current vehicle data as a digital value and as a diagram. Up to four parameters can be selected to be shown on the display.

For example:

- Engine speed
 - Wheel angle
 - Speed
 - Steering angle
- ▶ Set the desired parameters.
 - ▶ Set the time. The set parameters are evaluated in the diagram for the selected time.

Configuring AMG TRACK PACE

Requirements

To connect a mobile device to the TRACK PACE app:

- The TRACK PACE app is installed on the mobile end device.
- The mobile end device is connected to the multimedia system via Wi-Fi.

Multimedia system:

- ▶  **TRACK PACE** ▶▶ 

Connect mobile device via the TRACK PACE app

The TRACK PACE app makes it possible to record videos and to synchronize them with stored tracks.

- ▶ Select **TRACK PACE App**.
- ▶ Select **Authorize a New Device**.
- ▶ Start the TRACK PACE app on the device to be connected.
- ▶ Select **Next** and confirm the authorization prompt. A four-digit code is shown on the media display.
- ▶ Enter the code on the smartphone. The device is authorized.

De-authorizing the mobile device

- ▶ Select **TRACK PACE App**.
- ▶ Select a device.
- ▶ Confirm the prompt with **Yes**.
The device is de-authorized.

Setting the TRACK PACE display on the head-up display and driver's display

- ▶ Select **IC and HUD Contents**.
- ▶ Activate or deactivate the desired contents.
The contents on the head-up display and the driver's display are adapted.
- ⓘ For further information on the Head-up Display .
- ⓘ Further information about the driver's display .

Setting acoustic feedback

- ▶ Select **Acoustic Feedback**.
A scale with values from 0 to 10 is shown.
- ▶ Select a setting.

Displaying statistics

- ▶ Select **TRACK PACE Statistics**.
Statistics on the current user profile are displayed.
The following data are displayed:
 - Driving time
 - Track driven
 - Recorded tracks
 - Recorded Track Races
 - Laps recorded
 - Recorded Drag Races
 - Maximum design speed

Activating the ambient light

If this function is active, the vehicle interior is lit in red or green depending on delta time.

- ▶ Select **Ambient Light**.
- ▶ Activate or deactivate the function.

Adjusting the dashcam

If the vehicle is equipped with a dashcam, it can be used in AMG TRACK PACE.

- ▶ Select **Dashcam**.
- ▶ Select **Track Race** or **Drag Race** and activate **Activate Recording**.
- ▶ You can set which overlay is to be used in the recorded video under **Video Overlay Content**.

Notes on the care of tailpipes

⚠ WARNING Risk of burns from the tailpipe and tailpipe trims

The exhaust tailpipe and tailpipe trims can become very hot. If you come into contact with these parts of the vehicle, you could burn yourself.

- ▶ Always be particularly careful around the tailpipe and the tailpipe trims and supervise children especially closely in this area.
- ▶ Allow vehicle parts to cool down before touching them.

Observe the following notes in order to prevent damage to the vehicle:

- Clean the tailpipes with a cleaning agent recommended for Mercedes-Benz, especially in the winter and after washing the vehicle.
- Do not use acidic cleaning agents.

Operating fluids

Fuel

Notes on fuel quality for Mercedes-AMG vehicles

Observe the notes on operating fluids in the vehicle Owner's Manual.

! NOTE Damage caused by incorrect fuel

Even small amounts of the wrong fuel could result in damage to the fuel system, the engine and the emission control system.

- ▶ Only refuel with low-sulfur gasoline.

This fuel may contain up to 10 % ethanol by volume. Your vehicle is suitable for use with E10-fuel.

Never refuel with one of the following fuels:

- diesel
- gasoline with more than 10 % ethanol by volume-, e. g. E15, E85, E100

- gasoline with more than 3 % methanol by volume, e.g. M15, M30, M85, M100
- gasoline with metallic additives

If you have accidentally refueled with the wrong fuel:

- ▶ Do not switch on the vehicle.
- ▶ Consult a qualified specialist workshop.

If the available fuel is not sufficiently low in sulfur, it may produce unpleasant odors.

Refuel only with premium-grade unleaded gasoline with an octane number of at least 91 AKI/95 RON.

As a temporary measure, if the recommended fuel is not available, you may also use regular unleaded gasoline. In this case, note the octane number on the information label on the fuel filler flap (see vehicle Owner's Manual). Refueling with regular unleaded gasoline can reduce engine output and increase fuel consumption.

Never refuel using gasoline with an even lower RON.

! NOTE Premature engine wear through unleaded regular gasoline

Impairment of the longevity and performance of the engine.

If unleaded premium grade gasoline is unavailable and you have to refuel using unleaded regular gasoline:

- ▶ Only fill the fuel tank to half full with unleaded regular gasoline and refill as soon as possible with unleaded premium grade gasoline.
- ▶ Do not drive at the maximum design speed.
- ▶ Avoid sudden acceleration and engine speeds over 3000 rpm.

Further information on fuel is available in the following locations:

- at a gas station
- at a qualified specialist workshop
- **USA only:** on the <https://www.mbusa.com>

Tank content and fuel reserve (Mercedes-AMG vehicles)

Total fuel tank capacity

Model	
Mercedes-AMG GLA 35 4MATIC	13.5 gal (51.0 liters)
Mercedes-AMG GLB 35 4MATIC	15.9 gal (60.0 liters)

Fuel tank reserve

Model	
Mercedes-AMG GLA 35 4MATIC	1.3 gal (5.0 liters)
Mercedes-AMG GLB 35 4MATIC	1.6 gal (6.0 liters)

Engine oil quality and filling quantity (Mercedes-AMG vehicles)

Engine oil specification

Model	MB-Freigabe or MB-Approval
All models	229.71, 229.72 ¹⁾

1) Recommended for the lowest possible fuel consumption (lowest SAE viscosity class in each case, note possible limitations to the approved SAE viscosity class).

To achieve the lowest possible fuel consumption, the use of engine oil specifications marked with the lowest SAE viscosity class in the table is recommended. Observe any possible restrictions on the approved SAE viscosity classes.

Mercedes-AMG GLA: top the oil level up to the maximum before extreme driving maneuvers or operation on a racetrack.

Engine oil filling quantity

Model	Filling quantity
All models	5.3 US qt (5.0 liters)

The specified filling quantity refers to an oil change with the oil filter.

Coolant filling quantity (Mercedes-AMG vehicles)

Coolant (engine cooling circuit)

Model	Filling quantity
All models	8.7 US qt (8.2 liters)

Coolant and PAG oil filling capacity (Mercedes-AMG vehicles)

Refrigerant filling capacity

Model	Filling quantity
All models	18.7 ± 0.4 oz (530 ± 10 g)

Filling capacity for PAG oil

Model	
All models	2.8 ± 0.4 oz (80 ± 10 g)

Vehicle data

Vehicle dimensions (Mercedes-AMG vehicles)

The heights specified may vary as a result of the following factors:

- Tires
- Load
- Condition of the suspension
- Optional equipment

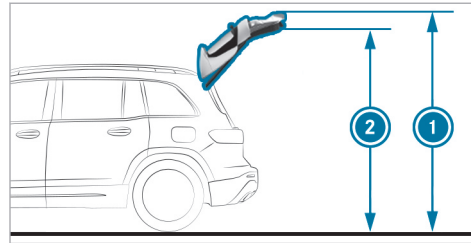

Mercedes-AMG GLB (example)

- ① Height when opened
- ② Headroom

Height when opened and headroom

Model	① Height when opened	② Headroom
Mercedes-AMG GLA 35 4MATIC	82.2 in (2087 mm)	73.8 in (1875 mm)
Mercedes-AMG GLB 35 4MATIC	81.3 in (2066 mm)	74.5 in (1893 mm)

Vehicle dimensions

Mercedes-AMG GLA 35 4MATIC	
Vehicle length	174.6 in (4436 mm)
Vehicle width including outside mirrors	79.5 in (2020 mm)
Vehicle height	62.6 in (1590 mm)
Wheelbase	107.4 in (2729 mm)
Turning circle	40.4 ft (12.3 m)
Mercedes-AMG GLB 35 4MATIC	
Vehicle length	183.1 in (4650 mm)
Vehicle width including outside mirrors	79.5 in (2020 mm)
Vehicle height	65.6 in (1665 mm)
Wheelbase	111.4 in (2829 mm)
Turning circle	41.0 ft (12.5 m)

Weights and loads (Mercedes-AMG vehicles)

Bear in mind that items of optional equipment increase the curb weight and reduce the payload. Vehicle-specific weight information can be found on the vehicle identification plate.

Display messages

Driving and driving safety systems

Display messages	Possible causes/consequences and ► Solutions
RACE START Canceled	<p>* Possible causes:</p> <ul style="list-style-type: none"> • You released the accelerator pedal during RACE START. • You depressed the brake pedal during RACE START. <p>► You can try RACE START again at the next start.</p>
AMG Ride Control Function Limited See Operator's Manual	<p>* At least one of the main functions of AMG RIDE CONTROL is malfunctioning. The system is outside the operating temperature range or the on-board electrical system voltage is too low. Once the cause of the problem is no longer present, the system will be available again.</p> <div style="border: 1px solid gray; padding: 5px; margin: 10px 0;"> <p>! NOTE The vehicle's suspension and damping behavior is restricted. The vehicle body may tilt heavily to the side during cornering.</p> <ul style="list-style-type: none"> ► Drive on carefully. ► Reduce speed considerably before taking a bend. ► Avoid sudden steering movements. </div> <p>► Drive on carefully.</p> <p>► Reduce speed considerably before taking a bend.</p> <p>► Avoid sudden steering movements.</p>



Display messages	Possible causes/consequences and ► Solutions
 <p data-bbox="144 339 421 391">Malfunction Do Not Exceed 50 mph</p>	<p data-bbox="469 249 1419 275">* AMG RIDE CONTROL is malfunctioning. The vehicle's handling characteristics may be affected.</p> <ul style="list-style-type: none"> <li data-bbox="493 283 1073 309">► Do not drive at speeds greater than 50 mph (80 km/h). <li data-bbox="493 318 916 343">► Consult a qualified specialist workshop.

Warning and indicator lamps

Engine

Warning/indicator lamp	Possible causes/consequences and ► Solutions
 <p data-bbox="144 709 408 761">Engine operating temperature warning lamp</p>	<p data-bbox="469 618 1639 667">*The blue warning lamp for engine operating temperature will remain lit until the engine operating temperature has been reached. The engine output and engine torque will remain reduced until then.</p> <ul style="list-style-type: none"> <li data-bbox="476 705 981 731">► Take this into consideration in your driving style.

Driving and driving safety systems

Warning/indicator lamp	Possible causes/consequences and ► Solutions
 <p data-bbox="195 384 445 436">Suspension warning lamp (yellow)</p>	<p data-bbox="510 291 1031 339">* The yellow AMG RIDE CONTROL warning lamp is lit. There is a malfunction in the AMG RIDE CONTROL.</p> <ul style="list-style-type: none"> <li data-bbox="528 350 957 376">► Note the messages on the driver display.
	<p data-bbox="510 454 1245 539">* The yellow ESP[®] OFF warning lamps are lit while the vehicle is running. ESP[®] is deactivated. Other driving systems and driving safety systems may also be inoperative.</p> <div data-bbox="528 557 1702 806" style="border: 1px solid gray; padding: 5px;"> <p data-bbox="537 567 1203 593">▲ WARNING Risk of skidding when driving with ESP[®] deactivated</p> <p data-bbox="547 612 1567 638">ESP[®] does not act to stabilize the vehicle. The availability of further driving safety systems is also limited.</p> <ul style="list-style-type: none"> <li data-bbox="547 648 759 674">► Drive on carefully. <li data-bbox="547 684 1147 710">► Deactivate ESP[®] only for as long as the situation requires. <p data-bbox="547 731 1060 757">If ESP[®] cannot be activated, ESP[®] is malfunctioning.</p> <ul style="list-style-type: none"> <li data-bbox="547 767 1234 793">► Have ESP[®] checked immediately at a qualified specialist workshop. </div> <ul style="list-style-type: none"> <li data-bbox="528 824 1097 850">► Observe the notes on deactivating ESP[®] (→ page 15).

Warning/indicator lamp	Possible causes/consequences and ► Solutions
 <p>The image shows a rectangular indicator lamp icon. The top half features a car silhouette with a wavy line underneath it, and the word "OFF" in bold capital letters. The bottom half is a solid black rectangle with the words "ESP SPORT" in white capital letters.</p>	<p>* ESP[®] SPORT is activated while the vehicle is running. When ESP[®] SPORT is activated, ESP[®] will stabilize the vehicle only to a limited extent.</p> <p>▲ WARNING Risk of skidding if ESP[®] SPORT is used incorrectly</p> <p>When you activate ESP[®] SPORT, there is an increased risk of skidding and having an accident.</p> <ul style="list-style-type: none">► Activate ESP[®] SPORT only in the circumstances described below. <p>► Observe the notes on activating ESP[®] SPORT(→ page 15).</p>

A		Steering wheel paddle shifters.....	14	Display messages	
AMG adaptive sport suspension system				 Malfunction Do Not Exceed 50	
Suspension.....	19			mph.....	40
AMG DYNAMIC SELECT				AMG Ride Control Function Limited	
Setting drive programs.....	13			See Operator's Manual.....	39
AMG Real Performance Sound.....	10			RACE START Canceled.....	39
AMG RIDE CONTROL				Drag Race.....	31
Selecting the suspension setting.....	20			Drive program display.....	12
AMG steering wheel buttons				Drive programs	
Setting.....	10			AMG DYNAMIC SELECT.....	13
AMG steering-wheel buttons				Selecting.....	12
Function.....	9			Driver display, Instrument cluster	
AMG TRACK PACE				Function/notes.....	21
Configuring.....	32			Track Pace menu.....	25
Drag Race.....	31			Driver's display	
Function.....	29			Classic menu.....	22
Telemetry display.....	32			Head-up display.....	27
Track Race.....	29			Operating.....	21
Automatic transmission				Status displays.....	28
Drive programs.....	11			Supersport menu.....	25
DYNAMIC SELECT button.....	11			Understated menu.....	22
Manual gear shifting.....	14				
Oil temperature (driver's display).....	26				
		B			
		Boost pressure, current (driver's display).....	26		
		C			
		Care			
		Tailpipes.....	34		
		Classic menu display content			
		Selecting.....	22		
		Climate control			
		Filling capacity for refrigerant and			
		PAG oil.....	36		
		Cockpit			
		Instrument panel.....	4		
		Coolant			
		Capacity.....	36		
		D			
		DIRECT SELECT lever			
		Manual gearshifting.....	14		
		Display (driver's display)			
		Overview of displays.....	28		

Driving safety system

ESP® (Electronic Stability Program)..... 15

DYNAMIC SELECT

Drive program display..... 12

Drive programs..... 11

Function..... 11

Selecting the drive program..... 12

E

E10..... 35

E25..... 35

ECO start/stop button

Automatic engine start/stop..... 10

ECO start/stop function

Switching off/on..... 10

Electronic Stability Program..... 15**Engine oil**

Capacity..... 36

MB-Freigabe or MB-Approval..... 36

Quality..... 36

Temperature (driver's display)..... 26

Engine oil temperature (driver's display)..... 26**Engine operating temperature**

Warning lamp..... 9

Engine output..... 9**Engine output, current (driver's display)**..... 26**Engine sound**..... 10**Engine torque**..... 9**ESP®**

Activating/deactivating..... 18

ESP® SPORT..... 15

Function..... 15

Setting (steering-wheel button)..... 17

F**Fuel**

E10..... 35

E25..... 35

Flexible fuel vehicles..... 35

Gasoline..... 35

Gasoline quality..... 35

Reserve..... 36

Sulfur content..... 35

Tank capacity..... 36

Fuel reserve..... 36**G****G-meter, Accelerometer**..... 26**Gasoline**..... 35**Gearshift**

Manual..... 14

Glide mode..... 15**H****Head-up display**

Function..... 27

I**Instrument panel**

Cockpit..... 4

M**Manual gearshifting**

Activating/deactivating..... 15

Menus (driver display)

Track Pace..... 25

Menus (driver's display)

Classic menu..... 22

U**Understated menu display content**

Selecting..... 22

V**Vehicle**

Equipment..... 6

Rocking free..... 14

Vehicle data

Turning circle..... 37

Vehicle height..... 37

Vehicle length..... 37

Vehicle width..... 37

Weights..... 38

Wheelbase..... 37

Vehicle dimensions..... 37**Vehicle equipment**..... 6**W****Warning/indicator lamp**

Engine operating temperature

warning lamp..... 40



Suspension warning lamp (yellow).. 41



