



2945848801

Order no. P294 0085 13 Part no. 294 584 88 01
Edition A-2024



EQE

Mercedes-AMG Supplement

Mercedes-Benz



Publication details

Internet

Further information about Mercedes-Benz vehicles and about Mercedes-Benz AG can be found on the following websites:

<https://www.mbusa.com> (USA only)

<https://www.mercedes-benz.ca> (Canada only)

Documentation team

©Mercedes-Benz AG: Not to be reprinted, translated or otherwise reproduced, in whole or in part, without written permission from Mercedes-Benz AG.

Vehicle manufacturer

Mercedes-Benz AG

Mercedesstraße 120

70372 Stuttgart

Germany

As at 26.09.22

Thank you for purchasing a Mercedes-AMG

Before your first drive, please read this Operator's Manual carefully and familiarize yourself with your vehicle. For your own safety and a longer service life of the vehicle, follow the instructions and warning notices in this Operator's Manual. Disregarding them may lead to damage to the vehicle or injury to people.

Damage to the vehicle resulting from the disregard of the instructions is not covered by the Mercedes-Benz Limited warranty.

The standard equipment and product description of your vehicle may vary and depends on the following factors:

- Model
- Order
- National version
- Availability

Your vehicle may therefore differ from that shown in the descriptions and illustrations in individual cases.

Mercedes-AMG reserves the right to introduce changes in the following areas:

- Design
- Equipment
- Technical features

The following documents are integral parts of the vehicle:

- Digital operator's manual
- Printed Operator's Manual
- Maintenance Booklet
- Supplementary manuals relating to specific equipment
- Supplementary documents

Keep these documents in the vehicle at all times. Ensure that all documents are in the vehicle or passed on in the event of sale or rental.

Mercedes-Benz USA, LLC

Mercedes-Benz Canada, Inc.

A Mercedes-Benz Group AG Company

2945848801





Symbols	3	MBUX multimedia system	27	Index	44
		AMG TRACK PACE	27		
		Sound	31		
At a glance	4	Breakdown assistance	32		
Cockpit	4	Removing the warning triangle	32		
General notes	6	Wheels and tires	33		
Operator's Manual	6	Changing a wheel	33		
		Installing/removing the hub cap	33		
Driving and parking	7	Technical data	35		
Driving	7	Operating fluids	35		
DYNAMIC SELECT	9	Vehicle data	35		
Driving and driving safety systems	11	Trailer hitch	37		
Driver's display	20	Display messages and warning/indicator lamps	40		
Notes on the driver's display	20	Display messages	40		
Operating the driver's display	20	Warning and indicator lamps	42		
Driver display menus	22				
Function of the head-up display	24				
Overview of status displays on the driver's display (Mercedes-AMG vehicles)	25				

In this Operator's Manual, you will find the following symbols:

 **WARNING** Danger due to failure to observe the warning notices

Warning notices draw your attention to hazards that may endanger your health or life, or the health or life of others.

 Observe the warning notices.

 **ENVIRONMENTAL NOTE** Environmental damage due to failure to observe environmental notes

Environmental notes include information on environmentally responsible behavior or environmentally responsible disposal.

 Observe environmental notes.

 **NOTE** Damage to property due to failure to observe notes on material damage

Notes on material damage inform you of risks which may lead to your vehicle being damaged.

 Observe notes on material damage.

 These symbols indicate useful instructions or further information that could be helpful to you.

 Instruction

(→ page) Further information on a topic

Display Display in the central display

 Highest menu level, which is to be selected in the multimedia system

 Relevant submenus, which are to be selected in the multimedia system

* Indicates a cause

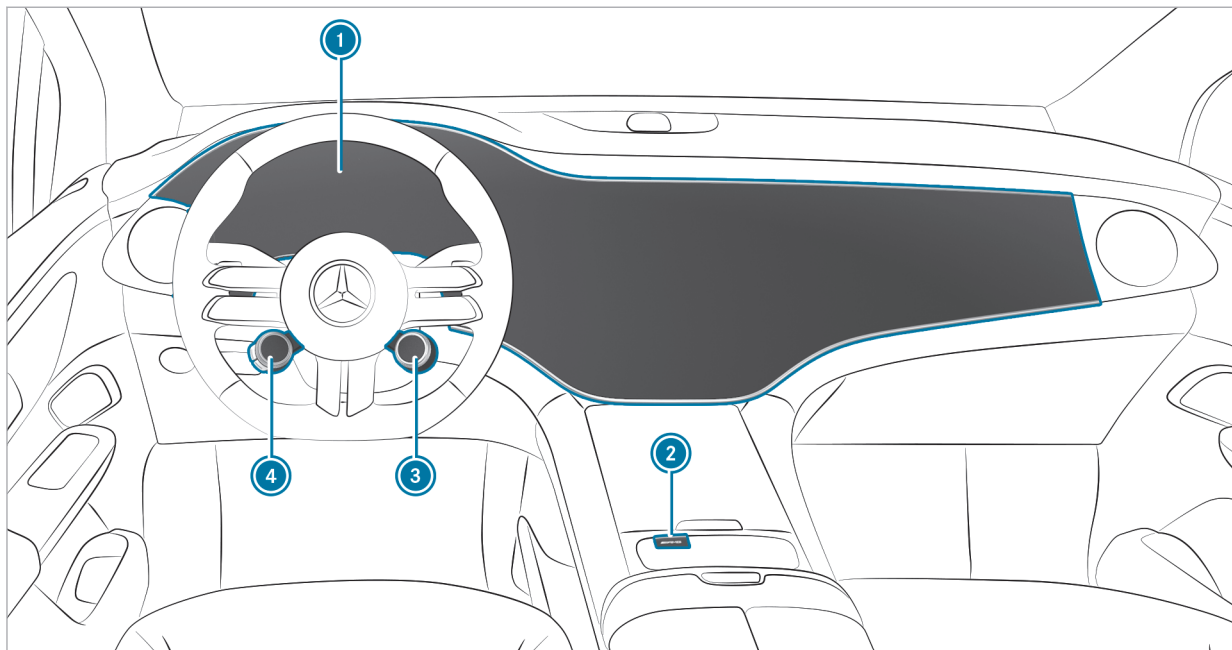

Left-hand drive vehicles

① Driver's display	→	20	③ Selects the drive program	→	10
② Sets AMG DYNAMIC SELECT in the MBUX multimedia system	→	10	④ AMG steering-wheel buttons	→	7

Operator's Manual

These Operating Instructions provide information on all the important functions of your AMG electric vehicle that are either not described or differ from the descriptions in the Operator's Manual. This information supplements or replaces the corresponding sections in the vehicle Operator's Manual. Under no circumstances do the Operating Instructions replace the printed vehicle Operator's Manual and the Digital Operator's Manual in the vehicle.

This Supplement and the Digital Operator's Manual in the vehicle describe the following models, standard and special equipment of your vehicle:

- Models, standard and special equipment available at the time of going to press with these Operating Instructions.
- The models and the standard and special equipment only available in certain countries.
- The models and the standard and special equipment, which will only be available at a later date.

Note that your vehicle may not be installed with all features described. This is also the case for systems relevant to safety. Therefore, the equipment on your vehicle may differ from that in the descriptions and illustrations.

The original purchase agreement for your vehicle contains a list of the equipment in your vehicle at the time of delivery.

Should you have any questions concerning equipment and operation, please consult an authorized Mercedes-Benz Center.

The Operator's Manual, Operating Instructions, further supplementary documents and Maintenance Booklet are important documents and should be kept in the vehicle.

Driving



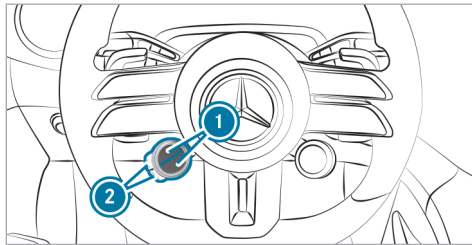

Function of the AMG steering-wheel buttons



The AMG steering-wheel buttons are an additional control element with two buttons on the steering wheel.

You can assign two vehicle functions of your choice to the control element. You can change between the available functions for the corresponding button ② by pressing the upper or lower part of the display button ① repeatedly. The display buttons ① show each function selected.

Depending on the vehicle's equipment, the following functions will be available:

-  ESP® (→ page 12)
-  AMG RIDE CONTROL + (→ page 16)
-  Camera views (see the vehicle Operator's Manual)
-  AMG DYNAMICS (→ page 9)
-  AMG Active Sound (→ page 8)

You can also select all functions that you have set as favorites in the multimedia system. Information on favorites in the multimedia system and their configuration (see vehicle Operator's Manual).

- ① Individual functions may not be shown. How functions are displayed and the order in which they are displayed can be set in the multimedia system (→ page 7).

If you have assigned a function to one of the display buttons ①, you can operate this function with the corresponding button ②.

The assignment of the display buttons ① remains stored even after the vehicle is started again. The

operating status of the respective function is, however, reset to the basic setting.

Setting the AMG steering wheel buttons

Multimedia system:

- ➔  ➔ Settings ➔ System
- ➔ Control Elements
- ➔ AMG Steer. Wheel Buttons

- ① The **SETTINGS SELECT** menu can also be called up using the AMG button in the center console or by pressing and holding the respective display button.

The left display buttons on the steering wheel can be set in the **SETTINGS SELECT** menu.

- ▶ Select the upper or lower display button in the central display and switch to editing mode by pressing and holding it.
 - ▶ Press  and select the desired function from the list.
- The selected function is assigned to the corresponding display button and can now be called up directly by simply pressing it.

Deleting button assignment



- ▶ Select the upper or lower display button and switch to editing mode by pressing and holding it.
- ▶ Press  to delete the selected display button assignment.

AMG Active Sound

Selecting supporting sound characteristic with the steering-wheel button

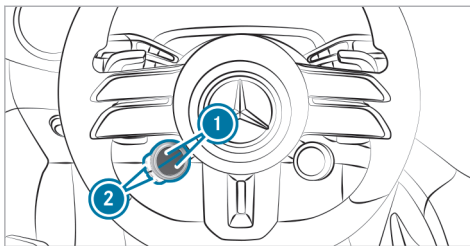
- ① You can select a comfortable (Balanced), a sporty (Sport) or a very sporty (Powerful) supporting sound characteristic for interior and drive noises using the steering-wheel button or the multimedia system (→ page 10).



- ▶ Press the upper or lower  display button repeatedly, until it displays the  symbol.

- ① If the display button does not show the symbol, then it is hidden. How functions are displayed and the order in which they are displayed can be set in the multimedia system (→ page 7).

- ▶ Press the corresponding button .

The color of the symbol  indicates the supporting sound characteristic currently selected:

- **Blue:** Balanced – comfortable
- **Orange:** Sport – sporty

- **Red:** Powerful – very sporty

Information on the AMG ceramic high-performance composite brake system

The brake system is designed for heavy loads. This may lead to noise when braking. This effect can also occur after washing the vehicle.

The noise depends on the following factors:

- speed
- brake force
- environmental conditions, e.g. temperature and air humidity



- ① Have the brake system checked at a qualified specialist workshop after it has been subjected to extreme loads.



DYNAMIC SELECT

Function of DYNAMIC SELECT (Mercedes-AMG vehicles)

DYNAMIC SELECT allows a drive program to be selected quickly according to the current driving conditions or the desired vehicle characteristics.

You can select between the following drive programs:



-  **Slippery**
 - Power level 1
 - With limited power release for optimized pulling away and driving characteristics in wintry and slippery road conditions
 - Kickdown not available
-  **Comfort**
 - Power level 2
 - With a moderate power release for comfortable driving and maximum range
-  **Individual**



- For individual drive, suspension, steering, ESP® and sound settings in the vehicle interior
-  **Sport**
 - Power level 3
 - With a somewhat limited power release for sporty driving
-  **Sport+**
 - Power level 4
 - Maximum power availability for particularly sporty driving

Depending on the drive program selected, the following vehicle characteristics will change:

- Drive and power availability
 - The power release for the drive is selected automatically depending on the drive program.
 - The four power levels are designed to provide constant power over as long a period as possible in the respective drive program.
- AMG Dynamics

- The three agility functions Basic, Advanced and Pro are automatically selected depending on the drive program.
- The steering, all-wheel drive and stabilization functions are adapted to the selected drive program.
 - Suspension
 - Steering
 - AMG Active Sound sound characteristic

The ESP® settings in the drive programs  and  are designed for stability. Therefore, choose one of these drive programs especially when transporting roof loads, in trailer operation and when the vehicle is fully loaded or fully occupied.

If you depress the accelerator pedal beyond the pressure point (kickdown), the maximum power is always available in all drive programs with the exception of the drive program . Kickdown is not available in the drive program .

- ① You can set the vehicle characteristics using the multimedia system (→ page 10).

10 Driving and parking

- i** You can also adjust the agility functions of AMG Dynamics using the AMG steering-wheel buttons.

Selecting a drive program (Mercedes-AMG vehicles)

Selection with right-hand steering-wheel button

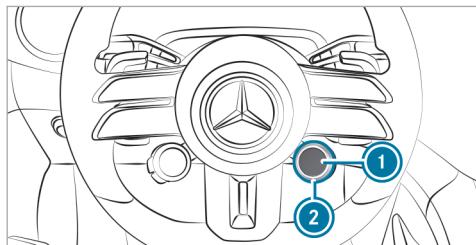

- ▶** Turn rotary switch **2**.
The selected drive program will appear on display button **1** and on the driver's display.
- i** Individual drive programs may not be shown.
How drive programs are displayed and the

order in which they are displayed can be set in the multimedia system (→ page 10).

- ▶** To select drive program **1*** directly: press display button **1**.

Selection via the central display (multimedia system)

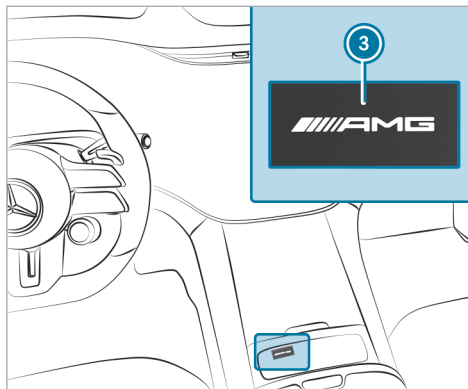

- ▶** Press button **3** and select the drive program via the central display (→ page 10).

Setting AMG DYNAMIC SELECT in the MBUX multimedia system

Multimedia system:

- ▶** **▶▶ Settings ▶▶ Vehicle**
- ▶▶ DYNAMIC SELECT**

Overview of the AMG DYNAMIC SELECT menu

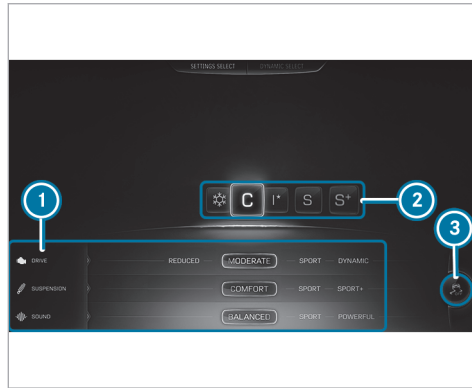

(Example representation) The representation and arrangement of content is equipment-dependent.

- ① AMG drive program settings
- ② Drive programs
- ③ ESP® (→ page 12)

① Depending on the equipment, the AMG **DYNAMIC SELECT** menu can also be called up using the AMG button in the center console.

▶ Select the appropriate drive program.

The settings of the drive programs can be adjusted individually.

▶ Select the desired tab on the left and make the relevant setting.

Setting options for the drive programs (equipment-dependent)

- AMG DYNAMICS:
Basic/Advanced/Pro
- Suspension:
Comfort/Sport/Sport+
- Sound:
Balanced/Sport/Powerful
- Drive (can only be set in the  drive program):
Reduced/Moderate/Sport/Dynamic

Driving and driving safety systems

Information about the AMG DYNAMIC PLUS package

① The AMG DYNAMIC PLUS package is an on-demand feature (see vehicle Operator's Manual).

! **NOTE** Vehicle and tire damage caused by non-approved tire types

Driving at increased maximum design speed is only approved for a specific types of tire.

▶ Before using the functions, observe the information on approved tire types. You could otherwise fail to recognize dangers.

You will find the information on the approved tire types in the "Wheels and tires" section (→ page 33).

The AMG DYNAMIC PLUS package includes the following functions:

- Increase in the maximum design speed of the

12 Driving and parking

- RACE START with boost function (→ page 15)
- Additional Performance Sound Experience for a particularly sporty driving experience

Function of ESP® (Mercedes-AMG vehicles)

You can select between the following modes of the Electronic Stability Program (ESP®):

- ESP® ON
- ESP® SPORT
- ESP® OFF

Characteristics when ESP® is activated

ESP® monitors and improves driving stability and traction, particularly in the following situations:

- When pulling away on wet or slippery roads.
- When braking.
- **Vehicles with trailer hitch:** in trailer operation from speeds of 40 mph (65 km/h), if the vehicle/trailer combination begins to sway from side to side.

- When there is a strong crosswind of 50 mph (80 km/h) or more.

ESP® can stabilize the vehicle by intervening in the following ways:

- One or more wheels are braked.
- The drive system output is adapted according to the situation.

ESP® is activated every time the vehicle is started regardless of whether ESP® SPORT or ESP® OFF was selected before the vehicle was switched off.

When the  warning lamp flashes, one or several wheels has reached its grip limit:



- Adapt the driving style to suit the prevailing road and weather conditions.
- Do not deactivate ESP® under any circumstances.
- Depress the accelerator pedal only as far as necessary.

Characteristics of ESP® SPORT

⚠ WARNING Risk of skidding if ESP® SPORT is used incorrectly

When you activate ESP® SPORT, there is an increased risk of skidding and having an accident.

▶ Activate ESP® SPORT only in the circumstances described below.

When ESP® SPORT is selected, the  and  warning lamps light up continuously.

Select ESP® SPORT when the vehicle's own oversteering and understeering characteristics are desired, e.g. on cordoned-off roads.

Driving with ESP® SPORT or with ESP® deactivated requires an extremely qualified and experienced driver.

If ESP® SPORT is activated and one or more wheels start to spin, the  warning lamp will flash. ESP® then stabilizes the vehicle only to a limited degree.

ESP® SPORT also has the following characteristics:



- ESP® improves driving stability only to a limited degree.
- ETS/4ETS traction control is still active.
- The power of the drive system is limited only slightly according to the situation and the drive wheels can spin.
The spinning of the wheels results in a cutting action for better traction on loose surfaces.
- ESP® continues to provide assistance when the brakes are firmly applied.
- **Vehicles with trailer hitch:** stabilization of the vehicle/trailer combination is no longer active.
- Crosswind Assist is no longer active.

Characteristics when ESP® is deactivated

▲ WARNING Risk of skidding if ESP® is deactivated

If you deactivate ESP®, ESP® cannot carry out vehicle stabilization.

▶ ESP® should only be deactivated in the following situations.

When ESP® is deactivated, the  and  warning lamps light up continuously.

Deactivating ESP® has the following effects:

- Driving stability will no longer be improved.
 - The drive wheels could spin.
 - ETS/4ETS traction control is still active.
 - **Vehicles with trailer hitch:** stabilization of the vehicle/trailer combination is no longer active.
 - Crosswind Assist is no longer active.
- i** Even when ESP® is deactivated, you are still assisted by ESP® when braking hard.

It may be best to activate ESP® SPORT or deactivate ESP® in the following situations:

- When using snow chains.
- In deep snow.
- On sand or gravel.

- i** Spinning the wheels results in a cutting action, which enhances traction.
- i** Activate ESP® as soon as the situations described above no longer apply. ESP® will otherwise not be able to stabilize the vehicle if the vehicle starts to skid or a wheel starts to spin.

If the  warning lamp lights up continuously, ESP® is not available due to a malfunction.

Observe the display messages, warning lamps and indicator lamps that are shown.

- Indicator and warning lamps
- Display messages

ETS/4ETS (Electronic Traction System)

ETS/4ETS traction control is part of ESP®.

ETS/4ETS can improve the vehicle's traction by intervening in the following ways:

- The drive wheels are braked individually if they spin.
- More drive torque is transferred to the wheel or wheels with traction.

Setting ESP® with the steering-wheel button

- i** You can also adjust ESP® via the multimedia system (→ page 14).

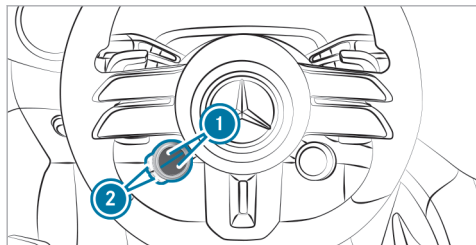

- ▶ **To set ESP®:** press upper or lower display button ① repeatedly, until it displays the symbol.
- i** If the display button does not show the symbol, then it is hidden. How functions are displayed and the order in which they are displayed can be set in the multimedia system (→ page 7).

The color of the road in the button symbol indicates the current setting:

- (blue): ESP® ON
- (yellow): ESP® SPORT
- (red): ESP® OFF

▶ **To set ESP® SPORT:** briefly press button ② when ESP® is activated.

The road in the button symbol will light up yellow.

The and warning lamps will appear on the driver's display.

▶ **To deactivate ESP®:** select ESP® SPORT and then press and hold button ②.

The road in the button symbol will light up red.

The and warning lamps will appear on the driver's display.

▶ **To activate ESP®:** briefly press button ② when ESP® SPORT is selected or ESP® is deactivated.

The road in the button symbol will light up blue.

The and or warning lamps will go out.

If the symbol is shown with a red ! on the display button, ESP® is malfunctioning. Observe the information on warning lamps and display messages which are shown on the driver's display.











Setting ESP® in the multimedia system

Multimedia system:

→ ▶ Settings ▶ Vehicle
▶ DYNAMIC SELECT

- i** Depending on the equipment, the AMG menu **DYNAMIC SELECT** can also be called up using the AMG button in the center console.

ESP® will always be activated when the vehicle is started. The road in the button symbol will light up blue.

- ▶ **To set ESP SPORT:** when ESP is activated, briefly press  to change to the **Sport** program.
The road in the  button symbol will light up yellow.
 - ▶ **To deactivate ESP®:** set the ESP® SPORT program and press and hold  to deactivate ESP®.
The road in the  button symbol will light up red. The  and  warning lamps will appear on the driver's display.
 - ▶ **To activate ESP :** briefly press  in ESP SPORT or if ESP is deactivated.
The road in the  button symbol will light up blue.
The  and  or  warning lamps will go out.
- i** You can also adjust ESP via the steering-wheel button (→ page 14).

RACE START

Information about RACE START

RACE START enables optimal vehicle acceleration from a standstill. A suitably high-grip road surface is required for this, and the tires and vehicle must also be in good condition.

- i** RACE START must not be used in normal road operation. RACE START may be activated and used only on dedicated race circuits, not on public roads.
Read the safety notes and information on ESP® (→ page 12).

⚠ WARNING Risk of skidding and having an accident from wheels spinning

If you use RACE START, depending on the ESP® mode selected, there is an increased risk of skidding and having an accident.

- ▶ Make sure that no persons or obstacles are in the close vicinity of your vehicle.

RACE START with boost function

The boost function for RACE START is available only for vehicles with the **AMG DYNAMIC PLUS package** (→ page 11).

If the activation conditions are fulfilled, the additional engine output will be added automatically during RACE START. In this case, vehicle acceleration from a standstill will be even more dynamic.

Activating RACE START

Requirements

- The vehicle is switched on and at normal operating temperature.
- The state of charge of the high-voltage battery is sufficient.
- The driver's door is closed.
- The front wheels are in a straight-ahead position.
- The vehicle is on level ground.
- The vehicle is stationary, the brake pedal is depressed (left foot) and the parking brake is released.
- The transmission is in position **D**.

- One of the drive programs **S** or **S*** is selected (→ page 9).

▶ Rapidly depress the accelerator pedal fully. The drive noise becomes louder and the vehicle vibrates. The seat belts on the driver and front passenger seats are pre-tensioned.

- ❗ If the activation conditions are not fulfilled, RACE START cannot be used. The **RACE START Not Possible See Operator's Manual** message appears in the driver's display.

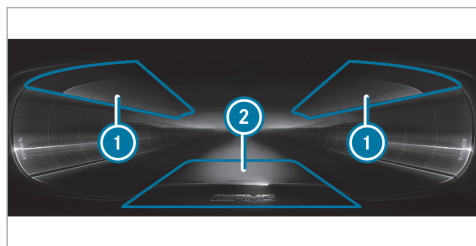

- ❶ RACE START display range activated
- ❷ Boost function display range available

- ❗ The display range ❶ displayed varies according to the selected menu for the driver's display.

▶ The display ranges ❶ flash red in the driver's display and the **RACE START Release Brake to Start** message appears.

RACE START with boost function: if RACE START with boost function is activated, the RACE START messages are supplemented with the **Boost Active** information. In addition, lower center display area ❷ will flash red (vehicles with AMG DYNAMIC PLUS package).

- ❗ If the brake pedal is not released after a short while, RACE START will be canceled. The **RACE START Canceled** message appears in the driver's display.

▶ Take your foot off the brake, but keep the accelerator pedal depressed. The vehicle will pull away at maximum acceleration. The **RACE START Active** message appears in the driver's display.

RACE START will be deactivated immediately if you release the accelerator pedal during RACE START or if any of the activation conditions are no

longer fulfilled. The **RACE START Canceled** message appears in the driver's display.

- ❗ After using it several times in quick succession, RACE START will be unavailable until a certain distance has been driven.

AMG RIDE CONTROL +

Function of AMG RIDE CONTROL +

AMG RIDE CONTROL + is an air suspension system with variable damping for improved driving characteristics. The all-round level control system ensures the best possible suspension and constant ground clearance, even with a laden vehicle. When driving at speed, the vehicle is lowered automatically to improve driving safety and to reduce energy consumption. You also have the option of manually adjusting the vehicle level.

The damping is set individually for each wheel and is affected by the following factors:

- The drive program selected
- Driving style, e.g. sporty
- Road condition, e.g. bumps

- The individual selection of **SPORT**, **SPORT +** or **COMFORT**

AMG RIDE CONTROL + includes the following components and functions:

- Air suspension with variable spring rate and automatic level control
- Speed-dependent lowering to reduce energy consumption
- increased vehicle level for greater ground clearance, selected via the multimedia system
- Adaptive Damping System with constant damping force adjustment

Suspension setting and vehicle level per drive program

Drive programs  and :



- The suspension setting is comfortable.
- The vehicle is set to the normal level.
- The vehicle is lowered while you are driving in the following cases:
 - You are driving faster than 75 mph (120 km/h) for at least 20 seconds.

- You are driving faster than 99 mph (160 km/h).

- The vehicle is raised to the normal level again in the following cases:

- You are driving slower than 62 mph (100 km/h) for at least one minute.
- You are driving slower than 50 mph (80 km/h).

Drive programs  and :

- The suspension setting is firm ().
- The suspension setting is even firmer ().
- The vehicle is set to low level.
- The vehicle is not lowered any further if you are traveling at higher speeds.

When the vehicle is started again, the **COMFORT** setting is activated automatically.

Selecting the suspension setting

-  You can also adjust the suspension setting via the multimedia system (→ page 10).

You can select from three different suspension settings:

- **COMFORT** ensures a comfortable suspension setting. Select this suspension setting if you prefer a comfortable driving style.
- **SPORT** lowers the vehicle to the lowest level and ensures a firmer suspension setting. Select this suspension setting when employing a sporty driving style, e.g. on winding country roads.
- **SPORT +** lowers the vehicle to the lowest level and ensures a very firm suspension setting.

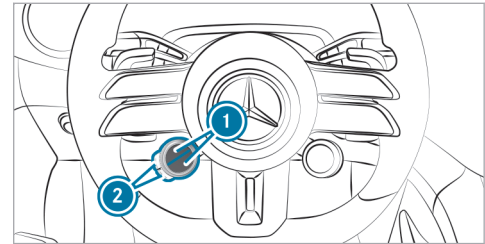



▶ Press upper or lower display button ① repeatedly, until it displays the  symbol.

① If the display button does not show the symbol, then it is hidden. How functions are displayed and the order in which they are displayed can be set in the multimedia system (→ page 7).

▶ Press corresponding button ②. The selected suspension setting is shown in the driver's display as a message.

The  symbol indicates the currently selected mode:

-  (blue): COMFORT
-  (yellow): SPORT
-  (red): SPORT +

Setting the vehicle level

⚠ WARNING Risk of accident because vehicle level is too high

Driving characteristics may be impaired. The vehicle can drift outwards, for example, when steering or cornering.

▶ Choose a vehicle level which is suited to the driving style and the road surface conditions.

⚠ WARNING Risk of entrapment from vehicle lowering

When lowering the vehicle, people could become trapped if their limbs are between the vehicle body and the tires or underneath the vehicle.

▶ Make sure no one is underneath the vehicle or in the immediate vicinity of the wheel arches when the vehicle is being lowered.

⚠ WARNING Risk of becoming trapped due to the vehicle lowering

Vehicles with AMG adaptive sport suspension system+ or level control system: when you unload luggage or leave the vehicle, the vehicle first rises slightly and then returns to the set level shortly afterwards.

You or anyone else in the vicinity of the wheel arches or the underbody could thus become trapped.

The vehicle can also be lowered after being locked.

▶ When leaving the vehicle, make sure that nobody is in the vicinity of the wheel arches or the underbody.

Multimedia system:



Raising the vehicle

Requirements for raising the vehicle:

- The vehicle has been started.
- The vehicle is not moving faster than 25 mph (40 km/h).
- When the trailer socket is contacted (trailer/bicycle rack): the vehicle is not moving faster than 19 mph (30 km/h).

▶ Select . The indicator lamp lights up continuously. The vehicle is raised to high level +1.

Your selection is saved. High level +1 set remains stored even after the vehicle has been switched off.

The vehicle is lowered again in the following situations:

- When driving faster than 44 mph (70 km/h).
- When the trailer socket is contacted (trailer/bicycle rack): the vehicle is moving faster than 19 mph (30 km/h).

GPS-based raising

If the function is activated, it is possible to save the vehicle position when the vehicle level is raised.

- ▶ Confirm the prompt.
The position of the vehicle is stored. When the previously stored position is reached again, a prompt appears in the Zero Layer as to whether the vehicle level should be raised again.

- ⓘ Settings for GPS-based raising
- ⓘ Zero Layer function

Lowering the vehicle

- ▶ Select .
The indicator lamp goes out.
The vehicle is adjusted to the normal level.
- ⓘ Use the normal level in trailer operation. High-level driving is not permitted in trailer operation on public roads.

Notes on the driver's display

⚠ WARNING Risk of accident if the driver display fails

If the driver display has failed or is malfunctioning, function restrictions in systems relevant to safety cannot be detected.

The operating safety of your vehicle may be impaired.

- ▶ Drive on carefully.
- ▶ Have the vehicle checked immediately at a qualified specialist workshop.

If the operating safety of your vehicle is impaired, park the vehicle immediately and safely. Contact a qualified specialist workshop.

The driver's display shows the following basic information:

- Speed and power meter level
- Range according to average consumption, personal driving style or high-consumption driving style
- State of charge of the high-voltage battery

- Indicator and warning lamps

- ① Observe the notes on the range in the Owner's Manual for the standard vehicle in the section "Notes on the range".
- ① Depending on the menu selected, the display and position of the range indicators and the recuperation indicator on the driver's display will vary (see Operator's Manual for the vehicle).

Functions available to you include the following:

- Various menus, such as Classic or Supersport
- Status displays for the driving systems
- Display messages

Operating the driver's display

⚠ WARNING Risk of distraction from information systems and communications equipment

If you operate information systems and communication devices integrated in the vehicle when driving, you could be distracted from the

traffic situation. This could also cause you to lose control of the vehicle.

- ▶ Only operate this equipment when the traffic situation permits.
- ▶ If you cannot be sure of this, stop the vehicle whilst paying attention to road and traffic conditions and operate the equipment with the vehicle stationary.

Observe the legal requirements for the country in which you are currently driving when operating the driver's display.

Calling up a menu via the driver's display menu bar

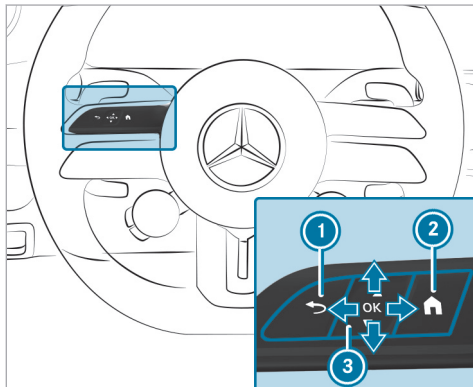

- ① Back button
- ② Main menu button
- ③ Touch Control

The content on the driver's display is controlled using the control elements on the left side of the steering wheel. You can use Touch Control ③ to

navigate vertically and horizontally by swiping with one finger. Confirm your selection by pressing the Touch Control.

- ① To operate Touch Control ③ in the most effective way, use the tip of your thumb if possible. You can also set the sensitivity of the Touch Control on the central display.
- ▶ Briefly press main menu button ②. The driver's display menu bar will open.



- ▶ Swipe to the left or right on left-hand Touch Control ③ and select a menu (e.g. the Supersport menu) on the menu bar.
- ▶ **To confirm:** press left-hand Touch Control ③.

The following menus can be called up via the menu bar on the driver's display:

- Understated
- Classic
- Navigation
- Assistance
- Offroad
- Service

In addition to these menus, the driver's display in Mercedes-AMG vehicles also features the Supersport menu.

On some of these menus, you can choose between different display content on the center display area.

The following Mercedes-AMG-specific display content, for example, can be set in the Classic menu:

- Temperature (high-voltage battery and front and rear high-voltage motors)
- Setup:
 - Drive

- AMG DYNAMICS
- Suspension
- Sound
- Engine data (current power and current torque)

i The settings for the setup display content can be configured either via the buttons on the multifunction steering wheel or via the MBUX multimedia system (→ page 10).

In the **Service** menu, in addition to the information on the message memory, tire pressure and **ASSYST PLUS**, there is a display for the temperature of the high-voltage battery and the high-voltage engines.

On most of the menus, you can use the **Options** sub-menu to configure further settings for the menu-specific display content.

Calling up or exiting the **Options** submenu

- ▶ **To call up:** press left-hand Touch Control **3**.
- ▶ **To exit:** press back button **1**.

Browsing through display content or lists

- ▶ Swipe up, down, left or right on left-hand Touch Control **3**.
- i** Within different menus, icons will also appear at the right edge of the center display section to indicate the current position on a list.

Setting display content as the standard display

You can set custom-configured menu display content as the standard display.

- ▶ Press and hold left-hand Touch Control **3** until the bar display that appears is completely filled.
The **Set Shortcut?** prompt will appear.
- ▶ Swipe left on left-hand Touch Control **3** and select **Yes**.
- ▶ **To confirm:** press left-hand Touch Control **3**.
- ▶ **To call up standard displays:** press back button **1** on the upper level of a menu.
- i** Pressing back button **1** on the standard display will call up the previous menu.

Resetting values

- ▶ **To call up the Options submenu:** press left-hand Touch Control **3**.
- ▶ **To select the function to be reset:** press left-hand Touch Control **3**.
- ▶ Select **Yes**.
- ▶ **To confirm:** press left-hand Touch Control **3**.

Driver display menus

Configuring settings on the Supersport menu

Driver's display:

↳ **Supersport**

- ▶ **To call up the menu:** press the left-hand Touch Control.
- ▶ **To select:** swipe upwards or downwards on the left-hand Touch Control and select the desired display content.

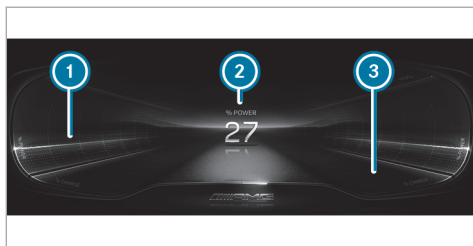

- ① Display range of the output
- ② Center display content (example: power display)
- ③ Display range of recuperated power (recuperation)
- i The displays for output ① and recuperated power ③ are given either as percentages or as absolute values.

Center display area ② of the **Supersport** menu shows the following display content:

- Power display (electrical drive support)
- Temperature indicator (high-voltage battery and front and rear high-voltage motors)

- Setup (drive, AMG DYNAMICS, suspension and sound)
- G-force
- Trip and total distance
- Distance **From Start** and **From Reset**
- Current consumption
- Audio
- Navigation

- i Depending on the vehicle equipment, AMG-specific content regarding temperature, engine data and setup will be displayed. The settings for the setup display content can be configured either via the buttons on the multi-function steering wheel or via the MBUX multimedia system (→ page 10).

Depending on the selected display content in center display area ②, the following will be displayed in the outer area of the menu:

- Power display as a percentage
- Current engine output and current torque

Calling up the Track Pace menu

Driver's display:

→ TRACK PACE

The Track Pace function is intended for use on designated race tracks. Do not use this function on public roads, and adapt your driving style to your personal capabilities and the ambient conditions.

The following options will be displayed on the **TRACK PACE** menu:

- G-meter
- Race track selected
- Braking and acceleration procedure
- Gear currently selected

24 Driver's display

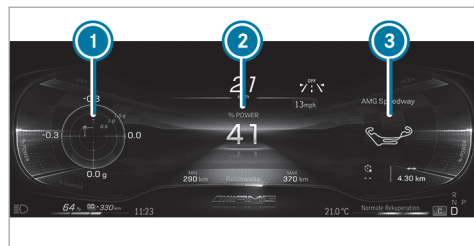

Displays on the Track Pace menu (example)

- 1 G-meter
- 2 Center display content (example: electric drive support display)
- 3 Telemetry display (example: selected race track)

▶ **To call up the menu:** press the left-hand Touch Control.

The display content of the **TRACK PACE** menu will adapt to the selected settings on the central display:

- Gear display
- Electric drive support display

- Recuperated power display
- G-meter
- Braking points
- Acceleration
- Quarter-miles
- Race track selected on the central display
- Current race
- Record route

While the vehicle is in motion, the G-meter shows the forces that are exerted on the vehicle occupants both laterally and in the direction of travel. The maximum values appear in red in the coordinate system.

Function of the head-up display

The head-up display projects various content into the driver's field of vision, for example.

You can use the head-up display menu bar to select various contexts, e.g.:

- Minimal
- Standard

- Supersport
- Off-road
- ECO display
- Settings
- Head-up display on/off

The following image shows an example of the Supersport context.

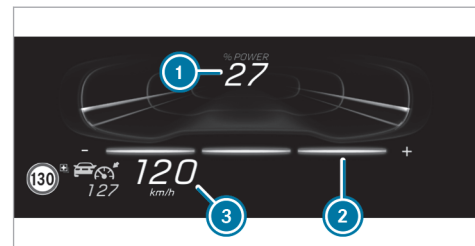

- 1 Output obtained as a percentage
- 2 Setting of the recuperation behavior
- 3 Current speed, set speed in the driving system (e.g. cruise control), detected traffic signs (Traffic Sign Assist)

When you receive a call, the  **Call Waiting** message will appear on the head-up display and the driver's display.

System limits

Visibility is particularly influenced by the following conditions:

- Seat position
- Image position setting
- Ambient light
- Wet road surfaces
- Objects on the display cover
- Polarization in sunglasses



Overview of status displays on the driver's display (Mercedes-AMG vehicles)



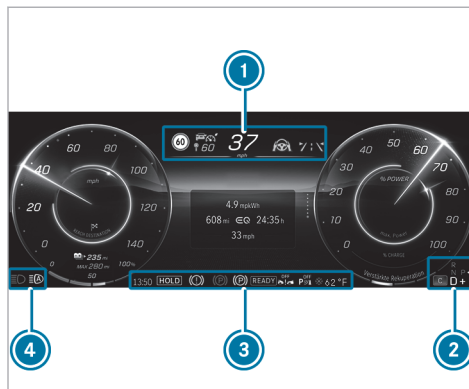











-  For more information on the individual driving and driving safety systems, see the Operator's Manual for the standard vehicle.

The status displays for the driving and driving safety systems in Mercedes-AMG vehicles can be found in display sections  to .



-  The number, positions and presentation of the status indicators on the driver's display depend on which systems are activated or deactivated.

-  Pedestrian detection (only on assistant display)
-  Active Parking Assist is available

-  Active Parking Assist has recognized a parking space
-  Parking Assist PARKTRONIC deactivated
-  Cruise control
-  Active Distance Assist DISTRONIC
-  Specified distance for Active Distance Assist DISTRONIC
-  Active Brake Assist switched off
-  Active Brake Assist impaired or not functioning
-  Active Lane Keeping Assist
-  Active Blind Spot Assist (only on assistant display)
-  HOLD function
-  Adaptive Highbeam Assist
Adaptive Highbeam Assist Plus
-  Slippery road surface warning
-  AMG RIDE CONTROL + (→ page 16)
-  AMG Active Sound (→ page 8)
-  AMG DYNAMICS (→ page 9)

26 Driver's display

Vehicles with Traffic Sign Assist: detected instructions and traffic signs

AMG TRACK PACE

Function of AMG TRACK PACE

i This function is an on-demand feature and can be activated via Mercedes me after you purchase your vehicle. The Digital Operator's Manual contains further information on Mercedes me and on-demand features.

With AMG TRACK PACE, the driving characteristics on race tracks can be analyzed and optimized. You can drive previously saved race tracks (e.g. the Hockenheimring), or record and save new tracks. The lap times set will be stored for every track. These can be analyzed and compared with other lap times to achieve the best possible race results. Additionally, acceleration and braking operations can be measured and stored.



Note: Use AMG TRACK PACE only on closed circuits away from public roads. Adapt your driving style to your personal skill level and environmental conditions. As the driver, you are solely responsible for driving your vehicle. Park your vehicle safely before operating the application.

Setting Track Race



Multimedia system:

↳ TRACK PACE ▶▶ Track Race

Recording a new track

- ▶ Select  **New Track** .
- ▶ Select  **Start Record**. at the desired starting point.
The track recording starts at this point.

During track recording, sectors can be set to divide up the track.



- ▶  Select **Set Sector**.
- ▶ Select  **Stop Recording** to end track recording or cross the starting line again.
- ▶ Confirm the prompt with **Yes**.
- ▶ Select the weather.

- i** The temperature is determined automatically.
- ▶ Enter a name.
- ▶ Press  to confirm.
The track is saved under the name entered.

Searching by track name



- ▶ Select  **Search** .
- ▶ Enter the track name.
Tracks with the searched name are displayed.

Measuring time on a saved track

- ▶  Select **All tracks**.
- ▶ Select the desired track.
- ▶ Select  .
- ▶ Select **Start Time Recording** if you are already at the starting line.

or



- ▶ Select **Navigate to** for navigation to the starting line.
Timing begins automatically when the starting line has been crossed.

- i** When  is selected, the track display can be switched to AR. In addition, it is possible to switch to the telemetry display by selecting  .
- ▶ Select  **Stop timekeeping** to end timekeeping.

- ▶ Confirm the prompt with **OK**.
- ▶ Select the weather.
- ▶ Select **Yes** to save the times driven for this track.



Showing readings during Track Race

The following readings can be shown:

- Tire temperature
 - Miniature map
 - Sector overview
 - Engine data
 - G-force display
 - Lap overview
- ▶ Select  **Start Time Recording** .
 - ▶ Select .
 - ▶ Drag the desired display from the grid on the left or right edge of the central display. The readings are shown during the Track Race.

By selecting  on the active display, you can deactivate this.

Displaying the analysis

- ▶  Select **All tracks**.
An overview of all the driven tracks appears.
- ▶ Select a track.
- ▶ Select a session.
The following data are displayed:
 - Lap and sector times
 - Average and top speed
 - Driver
 - Vehicle
 - Date
 - Weather
- ▶ Select **Add Recording** to use a different session as a reference value.
- ▶ Select  to return to the overview.
- ▶ Select **Diagram**.
- ▶ Set the desired parameters.
The analysis is displayed.

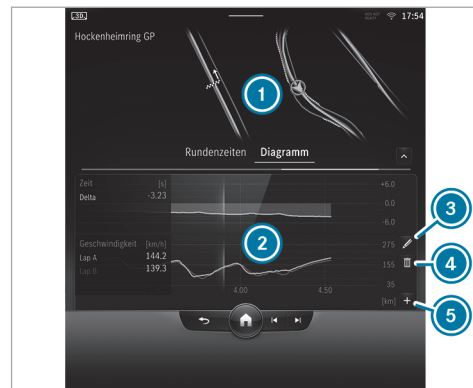



- ① Lap overview
 - ② Parameter overview
 - ③ Editing parameters
 - ④ Deleting parameters
 - ⑤ Adding new parameters
- ❗ The following values can be set for the parameters, for example:
- speed



- Longitudinal/lateral acceleration
- Steering angle
- Engine speed
- Engine oil/tire temperature

Based on the analysis, you can check and optimize the driving behavior for any position on the track.

Exporting tracks (USB)

- ▶ Select  **Tracks** .
An overview of all stored tracks appears.
- ▶ Select the desired track.
- ▶ Select options  for the desired track.
- ▶ Select **Export Track to...**
The selected track can be exported to a USB storage device connected to the vehicle.

Editing tracks and recordings

- ▶ Select  **Tracks** .
- ▶ Select the desired track.
- ▶ Select options  for the desired track.
- ▶ Select **Rename** or **Delete**.

or

- ▶ Select a track.
- ▶ Highlight the desired recording.
- ▶ Select  options.
- ▶ Select **Export to...** or **Delete**.

Setting Drag Race

Multimedia system:

↳ TRACK PACE ▶▶ Drag Race

Measuring acceleration

- ▶ Select  **Drag race options**.
- ▶ Select **Acceleration**.
- ▶ Set a starting speed or select **Automatic**.
Measurement will begin as soon as the specified starting speed has been reached.
- ▶ Set a target speed.
Measurement will stop as soon as the specified target speed has been reached.
- ▶ Start off and begin the measurement.
Measurement will begin when the vehicle accelerates.

You can stop measurement early by interrupting the acceleration procedure.

Quarter-mile race

- ▶ Select  **Drag race options**.
- ▶ Select **Quarter Mile**.
- ▶ Set a target distance.
Measurement will stop as soon as the specified target distance has been reached.
- ▶ Start off and begin the measurement.
Measurement will begin when the vehicle accelerates. Timing will run until the target distance or a maximum of one mile has been traveled.

You can stop measurement early by interrupting the acceleration procedure.

Measuring braking

- ▶  **Drag Race options**
- ▶ Select **Braking**.
- ▶ Set a starting speed or select **Automatic**.
- ▶ Start off and begin the measurement.

- ▶ Brake to a standstill. Measurement is incremental, in steps of 6 mph (10 km/h) to a standstill. If the braking procedure is started e.g. at a speed of 98 mph (157 km/h), measurement will start as soon as 93 mph (150 km/h) has been reached

Storing and calling up measured values

If a measurement is completed or canceled, a prompt will appear asking whether the measurement should be saved.

- ▶ Confirm the prompt with **OK** to save.

Calling up saved measurements

- ▶  Select **History**.
- ▶ Select **Acceleration**, **Quarter Mile** or **Braking**.
- ▶ Select a measurement. The desired measurement will be displayed in detail.

or

- ▶ Delete a measurement.

Calling up the telemetry display

Multimedia system:

- ▶  **TRACK PACE** ▶▶ **Telemetry**

The telemetry display shows current vehicle data as a digital value and as a diagram. Up to four parameters can be selected to be shown on the display.

For example:

- Engine speed
 - Wheel angle
 - Speed
 - Steering angle
- ▶ Set the desired parameters.
 - ▶ Set the time. The set parameters will be evaluated for the selected time on the diagram.

Configuring AMG TRACK PACE

Requirements

To connect a mobile device to the TRACK PACE app:

- The TRACK PACE app is installed on the mobile end device.
- The mobile end device is connected to the multimedia system via Wi-Fi.

Multimedia system:

- ▶  **TRACK PACE** ▶▶ 

Connect mobile device via the TRACK PACE app

The TRACK PACE app makes it possible to record videos and to synchronize them with stored tracks.

- ▶ Select **TRACK PACE App**.
- ▶ Select **Authorize a New Device**.
- ▶ Start the TRACK PACE app on the device to be connected.
- ▶ Enter the code on the smartphone. The device is authorized.

De-authorizing the mobile device

- ▶ Select **TRACK PACE App**.
- ▶ Select a device.
- ▶ Confirm the message prompt with Yes. The device is de-authorized.

Setting the TRACK PACE display on the head-up display and driver's display

- ▶ Select [IC and HUD Contents](#).
- ▶ Activate or deactivate the desired contents. The contents on the head-up display and the driver's display are adapted.

- ⓘ For further information on the Head-up Display .
- ⓘ Further information about the driver's display .

Setting acoustic feedback

- ▶ Select [Acoustic Feedback](#).
A scale with values from 0 to 10 is shown.
- ▶ Select a setting.

Displaying statistics

- ▶ Select [TRACK PACE Statistics](#).
Statistics on the current user profile are displayed.
The following data are displayed:
 - Driving time
 - Track driven

- Recorded tracks
- Recorded Track Races
- Laps recorded
- Recorded Drag Races
- Maximum design speed

Activating the ambient light

If this function is active, the vehicle interior is lit in red or green depending on delta time.

- ▶ Select [Ambient Light](#).
- ▶ Activate or deactivate the function.

Adjusting the dashcam

If the vehicle is equipped with a dashcam, it can be used in AMG TRACK PACE.

- ▶ Select [Dashcam](#).
- ▶ Select [Track Race](#) or [Drag Race](#) and activate [Activate Recording](#).
- ▶ You can set which overlay is to be used in the recorded video under [Video Overlay Content](#).

Sound



AMG Sound Experience

Calling up AMG Sound Experience

Multimedia system:

- ▶  ▶ [Settings](#) ▶ [Vehicle](#) ▶ [Driving](#) ▶ [Sound Experience](#)

Switching Sound Experience Events inside or outside on or off

- ▶ Switch [Sound Experience Events inside](#) or [Sound Experience Events outside](#) on  or off .

Selecting Sound Experience style

- ▶ Select a style, e.g. [Authentic](#).
- ⓘ The availability of the style is dependent on the equipment.

Removing the warning triangle

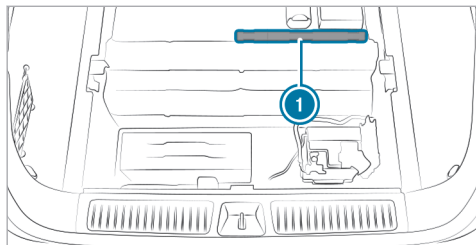

Warning triangle ① is located under the cargo floor.

- ▶ Remove warning triangle ①.

Changing a wheel

- ▶ Be sure to also observe the notes on changing a wheel in the Operator's Manual of your vehicle.

Vehicles with AMG Driver's Package:

⚠ WARNING Risk of accident caused by non-approved tire types

If you use tire types that have not been adapted to changes made to the factory speed limit, this can have the following consequences:

- The tires are not suitable for high speeds and the corresponding driving dynamics.
- The tires wear unevenly and affect the roadworthiness of the vehicle.
- ABS, ESP® and cruise control operation are restricted.

This can jeopardize road safety.

- ▶ Only use tire types that have been approved for the maximum permissible speed set and the vehicle.

Vehicles with AMG ceramic high-performance composite braking system:

⚠ NOTE Damage to the ceramic brake disc when changing a wheel

Mercedes-AMG vehicles with ceramic brake discs: during removal and repositioning of the wheel, the wheel rim can strike the ceramic-brake disc and damage it.

- ▶ Take particular care.
- ▶ Ask another person for assistance or use a second alignment bolt.

- ▶ When changing the wheel, avoid exerting any force on the brake disks. This can lead to impaired comfort during braking.

Installing/removing the hub cap

Requirements

- The vehicle is prepared for a wheel change (→ page 33).

Removing

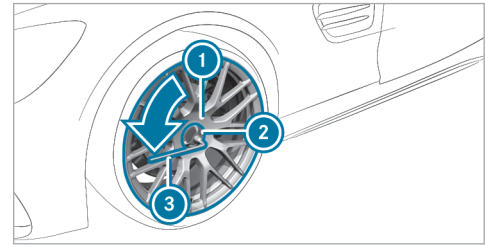

- ▶ Remove socket ② and wheel wrench ③ from the vehicle tool kit.
- ▶ Position socket ② on hub cap ①.
- ▶ Position wheel wrench ③ on socket ②.
- ▶ Using wheel wrench ③, turn hub cap ① counter-clockwise and remove it.

Installing

- ▶ Before installing, check hub cap ① and the wheel area for dirt, and clean if necessary.
- ▶ Position hub cap ① and turn until it is in the right position.
- ▶ Position socket ② on hub cap ①.
- ▶ Position wheel wrench ③ on socket ② and tighten hub cap ①.

ⓘ **Specified tightening torque:** 18 lb-ft (25 Nm)

Operating fluids

Coolant filling capacity (Mercedes-AMG vehicles)

Coolant (drive system cooling circuit)

Model	Capacity
Mercedes-AMG EQE 53 4MATIC+	11.6 US qt (11 liters)

Coolant (high-voltage battery cooling circuit)

Model	Capacity
Mercedes-AMG EQE 53 4MATIC+	13.7 US qt (13 liters)

Coolant and PAG oil filling capacity (Mercedes-AMG vehicles)

Refrigerant filling capacity

Model	Capacity
Mercedes-AMG EQE 53 4MATIC+	33.5 ± 0.4 oz (950 ± 10 g)

Filling capacity for PAG oil

Model	Capacity
Mercedes-AMG EQE 53 4MATIC+	5.6 ± 0.4 oz (160 ± 10 g)

Vehicle data

Vehicle dimensions (Mercedes-AMG vehicles)

The heights specified may vary as a result of the following factors:

- Tires
- Load
- Condition of the suspension
- Optional equipment

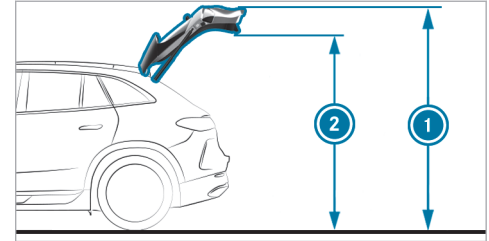

- ① Height when opened
- ② Height

Height when open and height

Model	① Height when opened	② Height
Mercedes-AMG EQE 53 4MATIC+	92.5 in (2350 mm)	83.5 in (2121 mm)

Vehicle dimensions

Mercedes-AMG EQE 53 4MATIC+	
Vehicle length	192.1 in (4879 mm)
Vehicle width including exterior mirrors	84.3 in (2141 mm)
Vehicle height	65.8 in (1672 mm)
Wheelbase	119.3 in (3030 mm)
Turning radius	35.8 ft (10.9 m)
Maximum ground clearance (AIRMATIC)	7.2 in (184 mm)
Minimum ground clearance (AIRMATIC)	5.5 in (139 mm)

Weights and loads (Mercedes-AMG vehicles)

Bear in mind that items of optional equipment increase the curb weight and reduce the payload. Vehicle-specific weight information can be found on the vehicle identification plate.

Off-road driving (Mercedes-AMG vehicles)

Also observe the notes on driving off-road, driving on hilly roads and fording in the vehicle's Operator's Manual.

Fording

! **NOTE** Damage caused by water when fording

In the following cases water can penetrate into the engine compartment and vehicle interior:

- The maximum permissible fording depth is exceeded when driving through standing water.
- When driving through the water a bow wave forms.
- Water accumulates when driving through running water.

▶ Do not exceed the maximum permissible fording depth and drive slowly through the water.

The specified value indicates the maximum permissible fording depth for vehicles that are in

roadworthy condition and for slow driving through standing water.

Driving through flowing water reduces the permissible fording depth due to the accumulation of water.

The specified values are maximum values for vehicles that are in ready-to-drive loading condition.

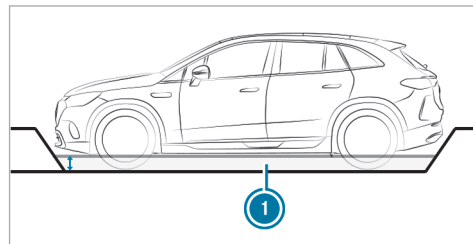

Fording depth

Model	1 Fording depth
Mercedes-AMG EQE 53 4MATIC+	11.8 in (30 cm)

Notes on the angle of approach/departure

The specified values are maximum values for vehicles that are in ready-to-drive loading condition.

On vehicles with AIRMATIC, loads up to the maximum payload have no influence on the approach/departure angles.

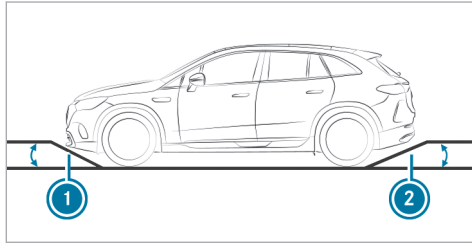

Angle of approach/departure

Model	① Angle of approach	② Angle of departure
Mercedes-AMG EQE 53 4MATIC+	17.5°	22.1°

High-voltage battery (Mercedes-AMG vehicles)

Missing values were not available at the time of going to press.

Energy content and charging times

Mercedes-AMG EQE 53 4MATIC+	
Type	Lithium-ion
Usable energy content	90.56 kWh
Range	
Charging time – mode 4 with a maximum charging capacity of 170 kW	Approx. 32 min
Charging time – mode 3 with 9.6 kW charging capacity	Approx. 10 h 45 min

–Mode 3 charging time applies to AC charging from 0 % to 100 % of the usable energy content. Charging time –mode 4 applies to DC charging from 10 % to 80 % of the usable energy content.

The time taken to charge the battery depends on the state of charge of the battery, the ambient temperature and the charging capacity of the battery. The charging capacity, in turn, depends on the supply voltage, the current intensity and the type of power supply.

The nominal voltage range for your vehicle can be found on the information label in the socket cover.

Trailer hitch

General notes on the trailer hitch

Modifications to the cooling system may be necessary, depending on the vehicle model. Retrofitting a trailer hitch is permissible only if a trailer load is specified in your vehicle documents.

Further information can be obtained at a qualified specialist workshop.

Observe the information and notes on the trailer hitch in the chapter entitled "Driving and parking" in the Operator's Manual.

Trailer load (Mercedes-AMG vehicles)

The drawbar load is not included in the towing capacity.

Missing values were not available at the time of going to press.

Towing capacity, braked (at a minimum start-off gradeability of 12 %)

Model	Towing capacity, braked
Mercedes-AMG EQE 53 4MATIC+	

Towing capacity, unbraked

Model	Towing capacity, unbraked
Mercedes-AMG EQE 53 4MATIC+	

Maximum tongue-weight and load capacity (Mercedes-AMG vehicles)

! NOTE Damage caused by the trailer coming loose

If the tongue weight used is too low, the trailer may come loose.

- ▶ The tongue weight must not be below 110.2 lbs (50 kg).
- ▶ Use a tongue weight that is as close as possible to the maximum permissible tongue weight.

! NOTE Damage caused by the bicycle rack coming loose

When using a bicycle rack, both the maximal tongue weight and the maximal load capacity should be observed.

- ▶ Do not exceed the permissible load capacity.

Missing values were not available at the time of going to press.

Trailer drawbar load

Model	Maximum tongue weight
Mercedes-AMG EQE 53 4MATIC+	

Load capacity

Model	Maximum load capacity
Mercedes-AMG EQE 53 4MATIC+	

Gross axle weight rating, rear axle (Mercedes-AMG vehicles)

Missing values were not available at the time of going to press.

Axle load when towing trailer

Model	Axle load
Mercedes-AMG EQE 53 4MATIC+	

Display messages



Driving and driving safety systems

Display messages	Possible causes/consequences and ► Solutions
RACE START Not Possible See Operator's Manual	<ul style="list-style-type: none"> * Possible causes are: <ul style="list-style-type: none"> • The activation conditions have not been fulfilled (→ page 15).
RACE START Canceled	<ul style="list-style-type: none"> * Possible causes: <ul style="list-style-type: none"> • You released the accelerator pedal during RACE START. • You depressed the brake pedal during RACE START. ► You can try RACE START again at the next start.
 Malfunction Do Not Exceed 50 mph	<ul style="list-style-type: none"> * AMG RIDE CONTROL + is malfunctioning. The vehicle's handling characteristics may be affected. <ul style="list-style-type: none"> ► Do not exceed 50 mph (80 km/h). ► Consult a qualified specialist workshop.
AMG Ride Control Function Limited See Operator's Manual	<ul style="list-style-type: none"> * At least one of the main functions of AMG RIDE CONTROL + is malfunctioning. The system is outside the operating temperature range or the on-board electrical system voltage is too low. Once the cause of the problem is no longer present, the system will be available again.

Display messages	Possible causes/consequences and ► Solutions
	<p data-bbox="554 253 1681 315">! NOTE The vehicle's suspension and damping behavior is restricted. The vehicle body may tilt heavily to the side during cornering.</p> <ul data-bbox="554 321 1681 424" style="list-style-type: none">▶ Drive on carefully.▶ Reduce speed considerably before taking a bend.▶ Avoid sudden steering movements. <ul data-bbox="554 440 1681 538" style="list-style-type: none">▶ Drive on carefully.▶ Reduce speed considerably before taking a bend.▶ Avoid sudden steering movements.

Warning and indicator lamps

Driving and driving safety systems

Warning/indicator lamp	Possible causes/consequences and ► Solutions
 <p data-bbox="144 425 395 474">Suspension warning lamp (yellow)</p>	<p data-bbox="458 332 999 381">* The yellow AMG RIDE CONTROL + warning lamp is lit. There is a malfunction in the AMG RIDE CONTROL +.</p> <ul style="list-style-type: none"> <li data-bbox="476 391 925 415">► Note the messages on the driver's display.
	<p data-bbox="458 494 1171 542">* The yellow ESP® OFF warning lamps are lit while the vehicle is running. ESP® is deactivated.</p> <p data-bbox="476 553 1195 581">Other driving systems and driving safety systems may also be inoperative.</p> <div data-bbox="482 598 1646 643" style="background-color: #f0f0f0; padding: 5px;"> <p data-bbox="493 608 1151 636">▲ WARNING Risk of skidding when driving with ESP® deactivated</p> </div> <p data-bbox="493 650 1517 678">ESP® does not act to stabilize the vehicle. The availability of further driving safety systems is also limited.</p> <ul style="list-style-type: none"> <li data-bbox="493 688 707 712">► Drive on carefully. <li data-bbox="493 723 1097 751">► Deactivate ESP® only for as long as the situation requires. <p data-bbox="493 774 1009 802">If ESP® cannot be activated, ESP® is malfunctioning.</p> <ul style="list-style-type: none"> <li data-bbox="493 813 1184 841">► Have ESP® checked immediately at a qualified specialist workshop.

Warning/indicator lamp	Possible causes/consequences and ► Solutions
 <p>The icon shows a car with a steering wheel, two curved arrows pointing outwards from the front, and the word 'OFF' below it. Below this is a rectangular box containing the text 'ESP SPORT'.</p>	<ul style="list-style-type: none"> ► Observe the notes on deactivating ESP® (→ page 12). <p>* ESP® SPORT is activated while the vehicle is running. When ESP® SPORT is activated, ESP® will stabilize the vehicle only to a limited extent.</p> <div style="background-color: #f0f0f0; padding: 5px; border: 1px solid #ccc;"> <p>⚠ WARNING Risk of skidding if ESP® SPORT is used incorrectly</p> <p>When you activate ESP® SPORT, there is an increased risk of skidding and having an accident.</p> <ul style="list-style-type: none"> ► Activate ESP® SPORT only in the circumstances described below. </div> <ul style="list-style-type: none"> ► Observe the notes on activating ESP® SPORT(→ page 12).

A		Telemetry display.....	30	Coolant	
AMG Active Sound , Sound, Vehicle sound		Track Race.....	27	Filling capacity (Mercedes-AMG vehicles).....	35
Selecting sound characteristic (steering-wheel button).....	8	Automatic transmission	9		
AMG adaptive sport suspension system +		Axle load		D	
Setting the vehicle level.....	18	Towing a trailer.....	38	Display (driver's display)	
AMG ceramic high-performance composite brake system	8			Overview of displays (Mercedes-AMG vehicles).....	25
AMG DYNAMIC PLUS package ,		B		Display messages	
Power increase.....	11	Battery (high-voltage on-board electrical system)	37	 Malfunction Do Not Exceed 50 mph	40
AMG DYNAMIC SELECT		Bicycle rack		AMG Ride Control Function Limited	
Setting drive programs.....	10	Load capacity.....	38	See Operator's Manual	40
AMG RIDE CONTROL +		Brakes		RACE START Canceled	40
Function.....	16	AMG ceramic high-performance composite brake system.....	8	RACE START Not Possible See Operator's Manual	40
Selecting the suspension setting.....	17			Drag Race	29
AMG steering wheel buttons		C		Drive program display	10
Setting.....	7	Climate control		Drive programs	
AMG steering-wheel buttons		Filling capacity for refrigerant and PAG oil.....	35	AMG DYNAMIC SELECT.....	10
Function.....	7	Cockpit		Selecting.....	10
AMG TRACK PACE		Overview.....	4		
Configuring.....	30				
Drag Race.....	29				
Function.....	27				

Driver display, Instrument cluster	
Function/notes.....	20
Track Pace menu.....	23
Driver's display	
Head-up display.....	24
Operating.....	20
Supersport menu.....	22
Driving safety system	
ESP® (Electronic Stability Program).....	12
Driving system	
AMG RIDE CONTROL +.....	16
Driving tips	
AMG ceramic high-performance composite brake system.....	8
AMG DYNAMIC PLUS package.....	11
DYNAMIC SELECT	
Drive program display.....	10
Drive programs.....	9
Function.....	9
Selecting the drive program.....	10
E	
Electronic Stability Program.....	12

ESP®	
Activating/deactivating.....	14
ESP® SPORT.....	12
Function.....	12
Setting (steering-wheel button).....	14

H

Head-up display	
Function.....	24
High-voltage battery	
Charging duration.....	37
Range.....	37
Type.....	37

I

Installing	
Tires/wheels.....	33

L

Level control	
AMG RIDE CONTROL +.....	16
Load capacity	
Bicycle rack.....	38

M

Menus (driver display)	
Track Pace.....	23
Menus (driver's display)	
Supersport.....	22

O

Operator's manual.....	6
-------------------------------	---

P

Program.....	9
---------------------	---

R

RACE START	
Activating.....	15
Activation conditions.....	15
Information.....	15
With boost function.....	15
Racetrack mode	
AMG ceramic high-performance composite brake system.....	8
AMG steering-wheel buttons.....	7

- S**
- Sound Experience**
 - Calling up Sound Experience..... 31
 - Supersport menu display content**
 - Selecting..... 22
 - Suspension**
 - AMG RIDE CONTROL +..... 16
 - Selecting the suspension setting..... 17
 - Setting the vehicle level..... 18
 - Suspension level**
 - Setting..... 18
- T**
- Technical data**
 - Axle load (trailer operation)..... 38
 - High-voltage battery..... 37
 - Tongue weight..... 38
 - Vehicle dimensions..... 35, 38
 - Telemetry display**..... 30
 - Tires**
 - Installing..... 33
 - Removing..... 33
 - Removing/installing hub cap..... 33
 - Removing/installing wheel trim..... 33
 - Tongue weight**..... 38
 - Touch Control**
 - Driver's display..... 20
 - Towing a trailer**
 - Axle load..... 38
 - Track Pace**
 - Menu (driver display)..... 23
 - Track Race**..... 27
 - Trailer hitch**
 - Axle load..... 38
 - General notes..... 37
 - Tongue weight..... 38
 - Transmission**
 - Drive programs..... 9
 - DYNAMIC SELECT button..... 9
- V**
- Vehicle**
 - Equipment..... 6
 - Vehicle data**
 - Angle of approach/departure (Mercedes-AMG vehicles)..... 36
 - Fording depth (Mercedes-AMG vehicles).. 36
 - Turning circle..... 35, 38
 - Vehicle height..... 35, 38
 - Vehicle length..... 35, 38
 - Vehicle width..... 35, 38
 - Weights..... 36
 - Wheelbase..... 35, 38
 - Vehicle dimensions**..... 35, 38
 - Vehicle equipment**..... 6
- W**
- Warning triangle**..... 32
 - Warning/indicator lamp**
 -  Suspension warning lamp (yellow).. 42
 - Wheel change**
 - Installing a new wheel..... 33
 - Removing a wheel..... 33
 - Removing/installing hub caps..... 33
 - Removing/installing wheel trim..... 33
 - Wheels**
 - Installing..... 33
 - Removing..... 33
 - Removing/installing hub cap..... 33

Removing/installing wheel trim..... 33

