



1775843507

Order no. P177 0396 13 Part no. 177 584 35 07
Edition B 2020



A-Class

Mercedes-AMG Supplement

Mercedes-Benz



Publication details

Internet

Further information about Mercedes-Benz vehicles and about Daimler AG can be found on the following websites:

<https://www.mbusa.com> (USA only)

<https://www.mercedes-benz.ca> (Canada only)

Documentation team

©Daimler AG: not to be reprinted, translated or otherwise reproduced, in whole or in part, without written permission from Daimler AG.

Vehicle manufacturer

Daimler AG

Mercedesstrasse 137

70327 Stuttgart

Germany

As at 17.05.2019

Thank you for purchasing a Mercedes-AMG

Before you first drive off, read this Operator's Manual carefully and familiarize yourself with your vehicle. For your own safety and a longer operating lifespan of the vehicle, follow the instructions and warning notices in this Operator's Manual. Disregarding them may lead to damage to the vehicle or injury to people.

Damage to the vehicle resulting from the disregard of the instructions is not covered by the Mercedes-Benz Limited Warranty.

The standard equipment or product description of your vehicle may vary and depends on the following factors:

- Model
- Order
- National version
- Availability

Mercedes-AMG reserves the right to introduce changes in the following areas:

- Design
- Equipment

- Technical features

The equipment in your vehicle may therefore differ from that shown in the descriptions and illustrations.

The following documents are integral parts of the vehicle:

- Digital Operator's Manual
- Printed Operator's Manual
- Maintenance Booklet
- Equipment-dependent Supplements

Keep these documents in the vehicle at all times. If you sell the vehicle, always pass all of the documents on to the new owner.

Mercedes-Benz USA, LLC
Mercedes-Benz Canada, Inc.
A Daimler Company

1775843507



Symbols	3	Function of the AMG steering-wheel buttons	20	Vehicle data	34
At a glance	4	Instrument Display and on-board computer	21	Display messages and warning/indicator lamps	35
Cockpit	4	Notes on the Instrument Display and on-board computer	21	Display messages	35
General notes	7	Calling up displays on the Performance menu	21	Warning and indicator lamps	36
Operator's Manual	7	Function of the Head-up Display	23	Index	38
Operating safety	7	MBUX multimedia system	24		
Qualified specialist workshop	8	AMG TRACK PACE	24		
Correct use of the vehicle	9	Breakdown assistance	30		
Limited Warranty	9	Flat tire	30		
Occupant safety	10	Wheels and tires	31		
Seat belts	10	Overview of the tire-change tool kit	31		
Airbags	10	Technical data	32		
Driving and parking	11	Operating fluids	32		
Driving	11				
DYNAMIC SELECT switch	13				
Automatic transmission	13				
Driving and driving safety systems	15				

In this Operator's Manual, you will find the following symbols:

⚠ DANGER Danger due to not observing the warning notices

Warning notices draw your attention to hazards that may endanger your health or life, or the health or life of others.

▶ Observe the warning notices.

🌿 ENVIRONMENTAL NOTE Environmental damage due to failure to observe environmental notes

Environmental notes include information on environmentally responsible behavior or environmentally responsible disposal.

▶ Observe environmental notes.

! NOTE Damage to property due to failure to observe notes on material damage

Notes on material damage inform you of risks which may lead to your vehicle being damaged.

▶ Observe notes on material damage.

ⓘ Useful instructions or further information that could be helpful to you.

▶ Instruction

(→ page) Further information on a topic

Display Information on the multifunction display/media display



Highest menu level, which is to be selected in the multimedia system



Corresponding submenus, which are to be selected in the multimedia system

* Marks a cause

4 At a glance – Cockpit

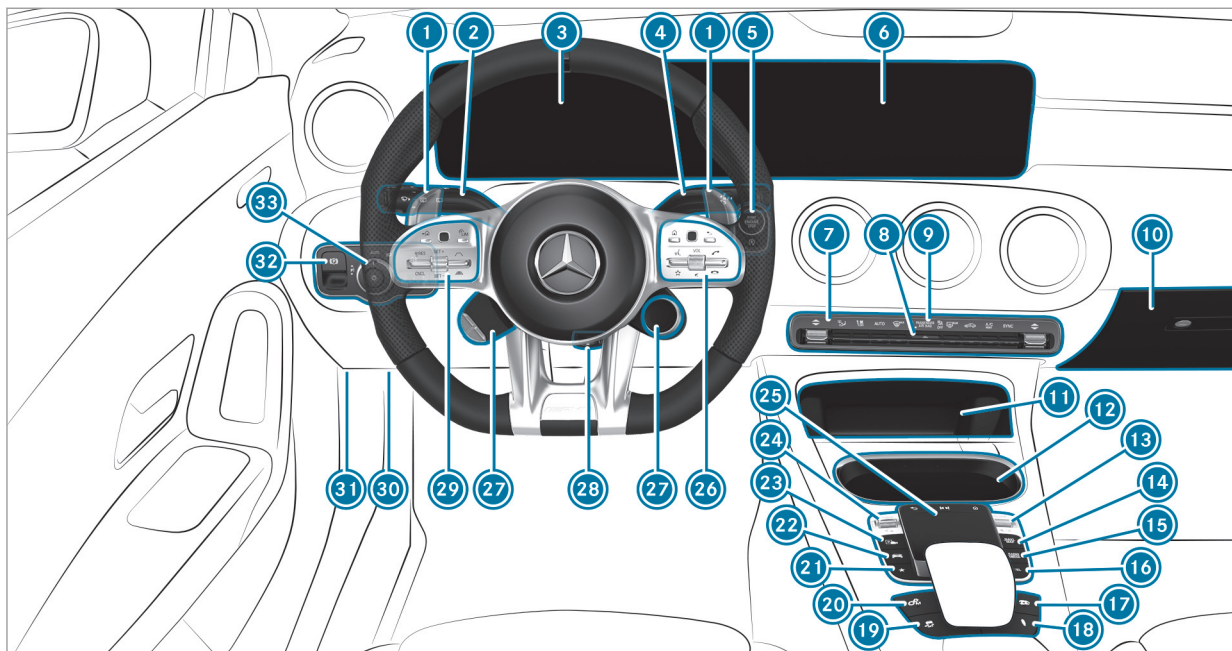

Left-hand drive vehicles

①	Steering wheel gearshift paddles	→	13	⑭	Calls up navigation		
②	Combination switch			⑮	Calls up the radio		
③	Instrument Display	→	21		Calls up media		
④	DIRECT SELECT lever			⑯	Calls up the telephone		
⑤	Start/stop button	→	11	⑰	AMG exhaust system	→	12
	ECO start/stop function	→	12	⑱	AMG adaptive sport suspension system	→	19
⑥	Media display			⑲	ESP®	→	15
⑦	Climate control systems			⑳	Manual gearshifting	→	13
⑧	Hazard warning lights			㉑	Calls up favorites		
⑨	PASSENGER AIR BAG indicator lamp			㉒	Calls up vehicle functions		
⑩	Glove box			㉓	Active Parking Assist		
⑪	Stowage compartment			㉔	DYNAMIC SELECT switch	→	13
⑫	Cup holder			㉕	Touchpad		
⑬	Control knob for:			㉖	Control panel for the MBUX multimedia system		
	Volume and switching sound on/off			㉗	AMG steering-wheel buttons	→	20
	Switches the MBUX multimedia system on/off			㉘	Adjusts the steering wheel		

6 At a glance – Cockpit

29 Control panel:

On-board computer → 21

Cruise control

Active Distance Assist DISTRONIC

30 Diagnostics connection

31 Opens the hood

32 Electric parking brake

33 Light switch

Operator's Manual

This Supplement provides information on all the important functions of your AMG vehicle that are either not described or differ from the descriptions in the vehicle Operator's Manual. This information supplements or replaces the corresponding sections in the vehicle Operator's Manual. Under no circumstances does the Supplement replace the Operator's Manual.

This Supplement describes all models, and standard and optional equipment for your vehicle, as available at the time of going to press. Country-specific differences are possible. Bear in mind that your vehicle may not feature all functions described here. This is also the case for systems and functions relevant to safety. Therefore, the equipment on your vehicle may differ from that in the descriptions and illustrations.

The original purchase contract documentation for your vehicle contains a list of all of the systems in your vehicle.

Should you have any questions concerning equipment and operation, please consult an authorized Mercedes-Benz Center.

The Operator's Manual, the Supplement and the Maintenance Booklet are important documents and should be kept in the vehicle.

Operating safety

▲ WARNING Risk of accident due to malfunctions or system failures

If you do not have the prescribed service/maintenance work or any required repairs carried out, this could result in malfunctions or system failures.

- ▶ Always have the prescribed service/maintenance work as well any required repairs carried out at a qualified specialist workshop.

▲ WARNING Risk of accident and injury as a result of incorrect modifications to electronic component parts

Modification to electronic components, their software or wiring could impair their function and/or the function of other networked component parts. In particular, systems relevant to safety could also be affected.

As a result, they may no longer function as intended and/or endanger the operating safety of the vehicle.

- ▶ Never tamper with the wiring and electronic component parts or their software.
- ▶ You should have all work on electrical and electronic components carried out at a qualified specialist workshop.

Observe the "On-board electronics" section in "Technical data" in the vehicle Operator's Manual.

⚠ WARNING Risk of fire due to flammable materials on hot parts of the exhaust system

Flammable material such as leaves, grass or twigs may ignite if they come into contact with hot parts of the exhaust system.

- ▶ When driving on unpaved roads or off-road, regularly check the vehicle underside.
- ▶ Remove trapped plants or other flammable material.
- ▶ If there is damage, consult a qualified specialist workshop immediately.

! NOTE Damage to the vehicle

In the following situations, in particular, there is a risk of damage to the vehicle:

- The vehicle becomes grounded, e.g. on a high curb or an unpaved road

- The vehicle is driven too fast over an obstacle, e.g. a curb, speed bump or pothole
- A heavy object strikes the underbody or chassis components

In situations such as this, the body, the underbody, chassis components, wheels or tires could be damaged without the damage being visible. Components damaged in this way can unexpectedly fail or, in the case of an accident, may not absorb the loads that arise as intended.

If the underbody paneling is damaged, flammable materials such as leaves, grass or twigs can collect between the underbody and the underbody paneling. These materials may ignite if they come into contact with hot parts on the exhaust system.

- ▶ Have the vehicle checked and repaired immediately at a qualified specialist workshop.

or

- ▶ If driving safety is impaired while continuing your journey, pull over and stop the vehicle immediately in accordance with the traffic conditions, and contact a qualified specialist workshop.

Qualified specialist workshop

An authorized Mercedes-Benz Center is a qualified specialist workshop. It has the necessary special skills, tools and qualifications to correctly carry out the work required on your vehicle. This particularly applies to safety-relevant works.

For the following, always have your vehicle checked at an authorized Mercedes-Benz Center:

- safety-relevant works
- service and maintenance work
- repair work
- modifications as well as installations and conversions
- work on electronic components

Mercedes-AMG recommends a Mercedes-Benz service center.

Correct use of the vehicle

If you remove any warning stickers, you or others could fail to recognize certain dangers. Leave warning stickers in position.

Observe the following information in particular when driving your vehicle:

- the safety notes in this manual
- technical data for the vehicle
- traffic rules and regulations
- laws and safety standards pertaining to motor vehicles

Limited Warranty

! **NOTE** Damage to the vehicle arising from violation of these operating instructions.

Damage to the vehicle can arise from violation of these operating instructions.

This damage is not covered either by the Mercedes-Benz implied warranty or by the New- or Used-Vehicle Warranty.

- ▶ Follow the instructions in these operating instructions on proper operation of your vehicle as well as on possible vehicle damage.

Seat belts

Reduced protection

The AMG sport seat and the AMG Performance seat are designed for the standard three-point seat belt. If you install a different multipoint seat belt, e.g. sport or racing seat belts, the restraint system cannot provide the intended level of protection.

Depending on the type of seat, there may be openings in the seat backrest. These openings have no function.

⚠ WARNING Risk of injury or fatal injury due to modified seat belt systems

If you feed seat belts through the opening in the seat backrest, the seat backrest may be damaged or may even break in the event of an accident.

- ▶ Only use the standard three-point seat belt.
- ▶ Never modify the seat belt system.

Airbags

Protection offered by the side airbag

Vehicles with AMG Performance seat: depending on the accident situation, the side airbag can increase the level of protection for the ribcage of the respective passenger in addition to a correctly fastened seat belt.

Driving

Breaking-in notes

To preserve the engine during the first 1,000 miles (1,500 km):

- drive at varying road speeds and engine speeds.
- do not drive faster than 85 mph (140 km/h).
- allow the engine to reach a maximum engine speed of 4,500 rpm (4,500 rpm) only briefly.
- drive the vehicle in drive program **C**.
- change gear before the tachometer needle is $\frac{2}{3}$ of the way to the red area of the tachometer.
- do not shift down a gear manually in order to brake.
- avoid overstraining the vehicle, e.g. driving at full throttle.
- do not depress the accelerator pedal past the pressure point (kickdown).
- only increase the engine speed gradually and accelerate the vehicle to full speed after 1,000 miles (1,500 km).

This also applies when the engine or parts of the drivetrain have been replaced.

Please also observe the following breaking-in notes:

- In certain driving and driving safety systems, the sensors adjust automatically while a certain distance is being driven after the vehicle has been delivered or after repairs. Full system effectiveness is not reached until the end of this teach-in process.
- Brakepads, brake discs and tires that are either new or have been replaced only achieve optimum braking effect and grip after several hundred kilometers of driving. Compensate for the reduced braking effect by applying greater force to the brake pedal.

Function of Emotion Start

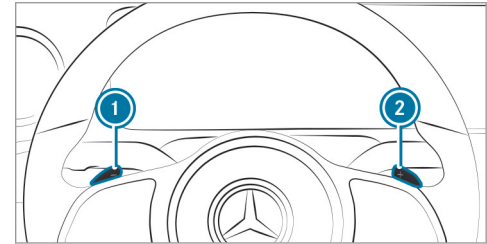

- ▶ Start the vehicle with the start/stop button and simultaneously pull one of steering wheel gearshift paddles ① or ②. The idle speed is briefly increased upon starting the engine, and in the sporty characteristic the engine sound is reproduced.

Observe the notes on starting the vehicle in the vehicle Operator's Manual.

12 Driving and parking

Operation of the ECO start/stop function

The engine is automatically switched off if the following conditions are met:

- If all vehicle conditions for an automatic engine stop are met.
- You brake the vehicle to a standstill in transmission position **D** or **N**.
- You depress the brake pedal when driving at speeds below 15 mph (20 km/h).

The **A** symbol appears in the multifunction display when the vehicle is stationary.

The engine is restarted automatically if:

- You release the brake pedal in transmission position **D** when the HOLD function is not active.
- You shift from transmission position **P**.
- You engage transmission position **D** or **R**.
- You depress the accelerator pedal.
- You permanently activate manual gearshifting.

- You pull the left-hand steering wheel gearshift paddle.
- An automatic engine start is necessary.

If the engine was switched off by the ECO start/stop function and you leave the vehicle, a warning tone sounds and the engine is not restarted. The **Vehicle Ready to Drive Switch the Ignition Off Before Exiting** display message also appears in the multifunction display. If you do not switch off the ignition, the ignition is automatically switched off after one minute.

AMG exhaust system

Operating the AMG exhaust system

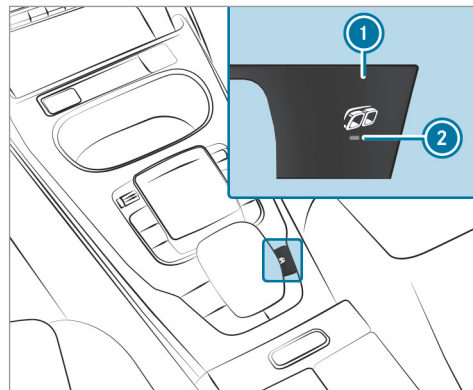

- ▶ Press button **1**. The sporty characteristic (Powerful) is selected when indicator lamp **2** lights up.

DYNAMIC SELECT switch

Function of the DYNAMIC SELECT switch

i This chapter describes the function of the DYNAMIC SELECT switch for the **Mercedes-AMG A 35 4MATIC**.

Use the DYNAMIC SELECT switch to change between the following drive programs:

- [S]** **(Slippery)**: optimized pulling away and driving characteristics in wintry and slippery road conditions
- [I*]** **(Individual)**: individual settings
- [C]** **(Comfort)**: comfortable and economical driving style
- [S]** **(Sport)**: sporty driving style
- [S+]** **(Sport +)**: particularly sporty driving style

Mercedes-AMG recommends selecting the drive program **[C]** when in city traffic or stop-and-go traffic.

Depending on the drive program selected, the following vehicle characteristics will change:

- Drive

- Engine and transmission management
- Active Distance Assist DISTRONIC
- AMG Dynamics
 - The agility functions are automatically selected depending on the drive program.
 - The steering, shift timing point and stabilization functions are adapted to the selected drive program.
- Suspension
- Availability of glide mode

Automatic transmission

Manual gearshifting

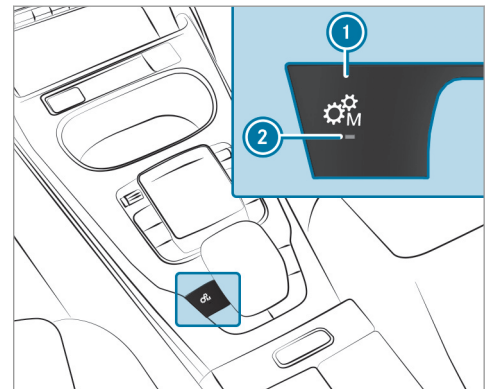

▶ **To activate/deactivate:** press button **1**. If indicator lamp **2** is lit, manual gearshifting is activated. The current gear is displayed in the multifunction display.

14 Driving and parking

- ① To permanently shift the gears manually in drive program **D** using the steering wheel gearshift paddles, select the **M** (Manual) setting for the transmission.

! **NOTE** Damage to the engine due to shifting up too late

The automatic transmission does not shift up in manual mode even when the engine's limiting speed is reached.

The fuel supply is interrupted in order to prevent the engine from overrevving.

- ▶ Shift up before the engine speed reaches the red area in the tachometer.

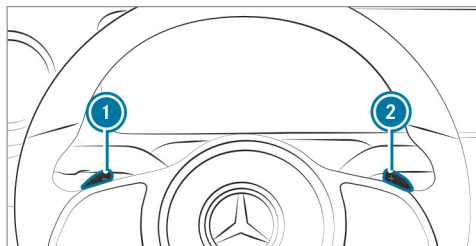

- ▶ **To shift up:** pull steering wheel gearshift paddle ②.
- ▶ **To shift down:** pull steering wheel gearshift paddle ①.

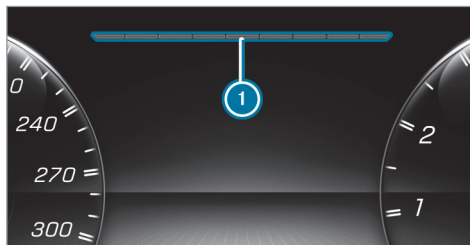

If the engine speed is too high or too low, you cannot change gear using the steering wheel gearshift paddles. In this case, segments ① light up red.

Gearshift recommendation

The gearshift recommendation assists you in adopting an economical driving style.

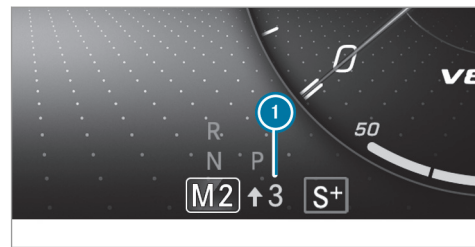

- ▶ If gearshift recommendation message ① is shown on the multifunction display, shift to the recommended gear.

Using kickdown

- ▶ **Maximum acceleration:** depress the accelerator pedal beyond the pressure point.

The automatic transmission shifts up to the next gear when the maximum engine speed is reached to protect the engine from overrevving.

- ❗ If you have activated manual gearshifting with the button in the center console, the transmission does not react to the kick-down.

Glide mode function

With an anticipatory driving style, glide mode helps you to reduce fuel consumption.

Glide mode is characterized by the following:

- The combustion engine is switched off. All of the vehicle functions remain active.
- The  symbol will appear on the multi-function display.

Glide mode is activated if the following conditions are met:

- The ECO start/stop function is switched on.
- Drive program  is selected with the drive setting "Moderate" or "Reduced".
- The speed is within a suitable range.
- The road's course is suitable, e.g. no steep uphill or downhill inclines or tight bends.

- You are no longer depressing the accelerator or brake pedal.

Glide mode is deactivated again if one of the conditions is no longer met.

When Active Distance Assist DISTRONIC is active, glide mode is not available.

Driving and driving safety systems

Functions of ESP® (Electronic Stability Program)

⚠ WARNING Risk of skidding if ESP® is malfunctioning

If ESP® is malfunctioning, ESP® cannot carry out vehicle stabilization. In addition, other driving safety systems are switched off.

- ▶ Drive on carefully.
- ▶ Have ESP® checked at a qualified specialist workshop.

You can select between the following modes of ESP®:

- ESP® ON
- ESP® SPORT
- ESP® OFF

Characteristics when ESP® is activated

ESP® monitors and improves driving stability and traction, particularly in the following situations:

- When pulling away on wet or slippery roadways.
- When braking.
- In strong side winds when you are driving faster than 47 mph (75 km/h).

ESP® can stabilize the vehicle by intervening in the following ways:

- One or more wheels are braked.
- The engine output is adapted according to the situation.

ESP® is activated every time the engine is started regardless of whether ESP® was in ESP®

16 Driving and parking

SPORT or deactivated before the engine was switched off.

If the  ESP[®] warning lamp flashes in the instrument cluster, one or several vehicle wheels has reached its grip limit:

- Adapt the driving style to suit the prevailing road and weather conditions.
- Do not deactivate ESP[®] under any circumstances.
- Only depress the accelerator pedal as far as is necessary.

Characteristics when ESP[®] SPORT is activated

▲ WARNING Risk of skidding if ESP[®] SPORT is used incorrectly

When you activate ESP[®] SPORT, there is an increased risk of skidding and having an accident.

- ▶ Activate ESP[®] SPORT only in the circumstances described below.

Select ESP[®] SPORT when the vehicle's own oversteering and understeering characteristics are desired, e.g. on designated roads.

Driving with ESP[®] SPORT or with ESP[®] deactivated requires an extremely qualified and experienced driver.

If ESP[®] SPORT is activated and one or more wheels start to spin, the  ESP[®] warning lamp on the instrument cluster flashes. ESP[®] then only stabilizes the vehicle to a limited degree.

ESP[®] SPORT also has the following characteristics:

- ESP[®] only improves driving stability to a limited degree.
- ETS/4ETS traction control is still active.
- The engine's torque is only restricted to a limited degree and the drive wheels can spin. The spinning of the wheels results in a cutting action for better traction on loose surfaces.

- ESP[®] continues to provide assistance when the brakes are firmly applied.
- Crosswind Assist is no longer active.

Characteristics when ESP[®] is deactivated

▲ WARNING Risk of skidding if ESP[®] is deactivated

If you deactivate ESP[®], ESP[®] cannot carry out vehicle stabilization.

- ▶ ESP[®] should only be deactivated in the following situations.

When ESP[®] is deactivated, the  ESP[®] OFF warning lamp and the **ESP OFF** message light up continuously in the instrument cluster.

Deactivating ESP[®] has the following effects:

- Driving stability will no longer be improved.
- The drive wheels could spin.
- ETS/4ETS traction control is still active.
- Crosswind Assist is no longer active.

- ❗ Even when ESP® is deactivated, you are still assisted by ESP® when braking hard.

It may be best to activate ESP® SPORT or deactivate ESP® in the following situations:

- When using snow chains.
 - In deep snow.
 - On sand or gravel.
- ❗ Spinning the wheels results in a cutting action, which enhances traction.
 - ❗ Activate ESP® as soon as the situations described above no longer apply. ESP® will otherwise not be able to stabilize the vehicle if the vehicle starts to skid or a wheel starts to spin.

If the  ESP® warning lamp lights up continuously even when ESP® is activated, ESP® is not available due to a malfunction.

Observe any information which may be displayed in the instrument cluster:

- Warning and indicator lamps
- Display messages

ETS/4ETS (Electronic Traction System)

ETS/4ETS traction control is part of ESP®.

ETS/4ETS can improve the vehicle's traction by intervening in the following ways:

- The drive wheels are braked individually if they spin.
- More drive torque is transferred to the wheel or wheels with traction.

Activating/deactivating ESP® (Electronic Stability Program)

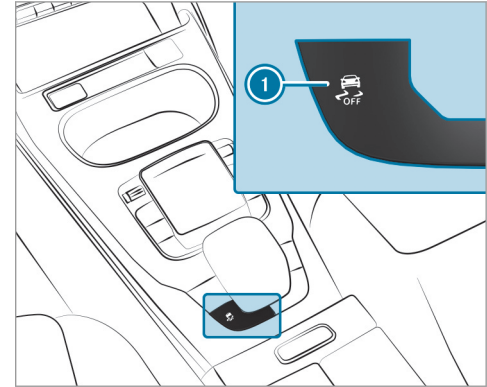

- ▶ **To activate ESP® SPORT:** briefly press button . The  and  warning lamps appear in the instrument cluster.

- ▶ **To deactivate ESP® SPORT:** briefly press button . The  and  warning lamps in the instrument cluster go out.
- ▶ **To deactivate ESP®:** press and hold button  until the  and **ESP OFF** warning lamps appear in the instrument cluster.
- ▶ **To activate ESP®:** briefly press button . The  and **ESP OFF** warning lamps go out in the instrument cluster.

Observe the information on warning lamps and display messages which may be shown in the instrument cluster.

RACE START

Function of RACE START

RACE START enables optimal vehicle acceleration from a standstill. For this, a suitably high-grip road surface is required, the tires and vehicle must also be in good condition.

- ⓘ RACE START is only available after the vehicle has been broken in (→ page 11).

- ⓘ RACE START may not be used on normal roads. RACE START must only be activated and used on dedicated race circuits, not on public roads. Be sure to read the safety notes and information on ESP® (→ page 15).

⚠ WARNING Risk of skidding and having an accident from wheels spinning



When you use RACE START, individual wheels could spin and you could lose control of the vehicle.

Depending on the ESP® mode selected, there is an increased risk of skidding and having an accident.

- ▶ Make sure that no persons or obstacles are in the close vicinity of your vehicle.

Activating RACE START Requirements:

- The doors, the hood and the tailgate are closed.

- The engine is running and the transmission and engine are at normal operating temperature.
- The steering wheel is in the straight-ahead position.
- The vehicle is on level ground.
- The vehicle is stationary, the brake pedal is depressed (left foot) and the parking brake is released.
- One of the drive programs ,  or  is selected .
- ▶ Rapidly depress the accelerator pedal fully. The engine speed increases.
- ⓘ If the activation conditions are not fulfilled, RACE START cannot be activated. The **RACE START Not Possible** See Operator's Manual message appears in the multifunction display.
- ▶ The **RACE START Release brake to start** message appears in the multifunction display.

i Mercedes-AMG A 45 4MATIC and A 45 S 4MATIC: in this phase you can adjust RACE START depending on the road conditions: you can vary the engine speed by pulling on one of the steering wheel gearshift paddles. The segments in the multifunction display flicker rapidly.

i If the brake pedal is not released after a short while, RACE START is canceled. The **RACE START Canceled** message appears in the multifunction display.

▶ Take your foot off the brake, but keep the accelerator pedal depressed. The vehicle pulls away at maximum acceleration. The **RACE START Active** message appears in the multifunction display.

RACE START is deactivated when the vehicle reaches a speed of approximately 31 mph (50 km/h).

RACE START is deactivated immediately if you release the accelerator pedal during RACE START or if any of the activation conditions are no longer fulfilled. The **RACE START Canceled** message appears in the multifunction display.

i After using it several times in short succession, RACE START is unavailable until a certain distance has been driven.

AMG adaptive sport suspension system

Function of AMG adaptive sport suspension system

AMG adaptive sport suspension system is an electronically controlled damping system for improved driving comfort and increased driving safety.

The damping is adjusted individually to each wheel and depends on the following factors:

- The driving style, e.g. sporty
- The road condition, e.g. bumps
- The drive program selected
- The individual selection of the "Sport", "Sport Plus" or "Comfort" suspension setting

The suspension setting is dependent on the drive program selected via the DYNAMIC SELECT switch.

In addition, you can select the mode in every drive program individually via the AMG adaptive sport suspension system button in the center console. After a drive program is changed, the automatic suspension setting of the drive program is reactivated.

AMG adaptive sport suspension system, selecting the suspension setting

In "Comfort" mode, the driving characteristics of your vehicle are comfortable. Select this suspension setting if you prefer a comfortable driving style.

"Sport" driving mode ensures a firmer suspension setting. Select this suspension setting when employing a sporty driving style, e.g. on winding country roads.

"Sport Plus" driving mode ensures a very firm suspension setting.

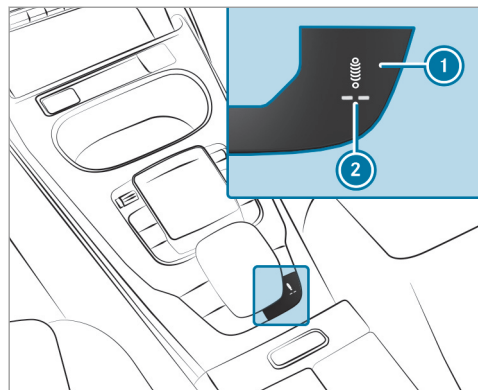

▶ Press button ① repeatedly until the selected setting is displayed.

Depending on the number of indicator lamps ② lighting up, the following suspension setting is selected:

- 0 - "Comfort" suspension setting
- 1 - "Sport" suspension setting
- 2 - "Sport Plus" suspension setting

The currently selected suspension setting is shown as a display message in the media display.

Function of the AMG steering-wheel buttons

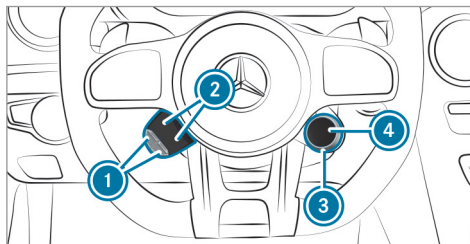

The AMG steering-wheel buttons are two additional control elements on the steering wheel.

You can assign two vehicle functions of your choice to the left control element. You can change between the available functions by pressing display buttons ② repeatedly. The currently selected functions are displayed in display buttons ②.

The following functions are available:

- ESP®(→ page 15)
- AMG adaptive sport suspension system (→ page 19)
- AMG exhaust system(→ page 12)
- ECO start/stop function (→ page 12)
- Manual gearshifting (→ page 13)



If you have assigned a function to one of display buttons ②, you can operate this function with corresponding button ①.

The assignment of display buttons ② remains stored even after a new engine start, but the operating status of the respective function is reset to the basic setting.

You can change between the drive programs with rotary actuator ③. The selected drive program appears in display button ④. By pressing display button ④, you can directly access the drive program  (**Individual**) .

Notes on the Instrument Display and on-board computer

Additional notes regarding your Mercedes-AMG vehicle:

- If you activate manual gearshifting, (→ page 13) the upshift bar will appear on the multifunction or Head-up Display. In addition, transmission set-up **M** (manual) and the current gear will appear on the transmission position display of the multifunction display.
- Additional note regarding the indicator and warning lamps: the vehicle is also equipped with the ESP® , ESP® OFF  and ESP® SPORT  indicator and warning lamps (→ page 36).

You can select the following display content:

- Tachometer with gear display
- Date and time
- Warm-up
- AMG TRACK PACE
- G-meter

- Engine data
- SETUP
- Trip computer
- Navigation
- Media
- Telephone

AMG TRACK PACE is displayed on the left-hand section of the display. The warm-up, engine data, SETUP and G-meter menus are displayed on the right-hand section of the display.

Calling up displays on the Performance menu

On-board computer:

↳ Performance

▶ **To select a display:** swipe upwards or downwards on the left-hand Touch Control.

Displays on the Performance menu:

- Warm-up
- Engine data

- SETUP
- G-meter

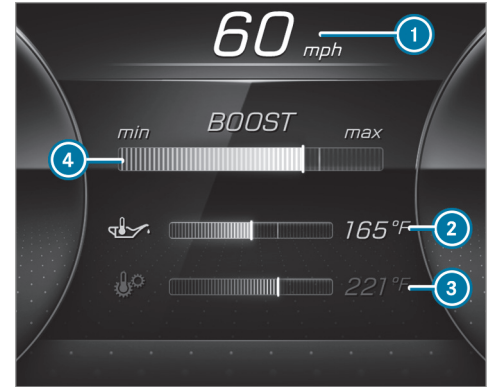

Warm-up (example)

- ① Digital speedometer
- ② Engine oil temperature
- ③ Transmission oil temperature
- ④ Boost pressure

22 Instrument Display and on-board computer

If the engine or transmission is not at normal operating temperature, the multifunction display will show temperature ② or ③ in blue. Avoid using the full engine power output during this time.

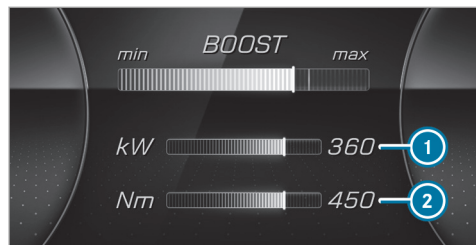

Engine data (example)

- ① Current power output
- ② Current torque

When current power output ① or current torque ② reaches the maximum value, the digital value will briefly be stationary. The bar display will continue.



SETUP in Mercedes-AMG vehicles (example)

- ① Drive system setting:
Reduced/Moderate/Sport/Dynamic
- ② Transmission position:
D/M
- ③ AMG DYNAMICS:
Basic/Advanced/Pro/Master
- ④ Suspension tuning:
Comfort/Sport/Sport+
- ⑤ Exhaust system:
Balanced/Powerful

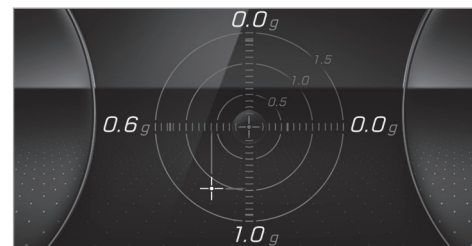

G-meter (example)

While the vehicle is in motion, the G-meter shows the forces that are exerted on the vehicle occupants both laterally and in the direction of travel. The maximum values are represented by red markings.

- ▶ **To reset the G-meter:** press the left-hand Touch Control.
- ▶ Select **Yes**.
- ▶ Press the left-hand Touch Control.

Function of the Head-up Display

The Head-up Display projects information above the cockpit into the driver's field of vision, e.g. the speed of the vehicle, information from the navigation system or driver assistance systems and some warning messages.

Depending on the vehicle's equipment, different content can be shown in the three areas of the Head-up Display.

Mercedes-AMG display content

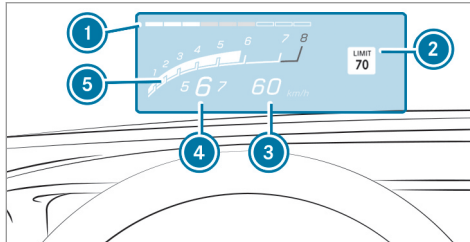

- ① Protection from reaching the overrevving range
- ② Detected instructions and traffic signs

- ③ Current speed
- ④ Currently selected gear, gearshift options with manual shifting
- ⑤ Current engine speed

Depending on the vehicle's equipment, you can select further AMG displays in addition to the standard displays on the [Display Content](#) menu.

In vehicles with AMG TRACK PACE, you can display additional content:

- Speed and gear display
 - Lap and sector times
 - Acceleration and braking
 - Track layout graphics
- ① The content that can be displayed will vary depending on the settings.

When you receive a call, the  [Incoming Call](#) message will appear on the Head-up Display.

In audio mode, the station name or track will be shown temporarily when the audio source is being actively operated.

System limits

The visibility of the displays will be affected by the following conditions:

- Seat position
 - Image position setting
 - Ambient light
 - Wet roadway
 - Objects on the display cover
 - Polarization in sunglasses
- ① In extreme sunlight, sections of the display may appear washed out. You can correct this by deactivating and reactivating the Head-up Display.

AMG TRACK PACE

General information

With AMG TRACK PACE, the driving characteristics on race tracks can be analyzed and optimized. You can drive previously stored race tracks (e.g. Hockenheimring), or new tracks can be recorded and stored. The driven lap times are stored for every track. These can be analyzed and compared to other lap times to achieve the best possible race results. Additionally, acceleration and braking procedures can be measured and stored.



Please note: Use AMG TRACK PACE only on closed-off routes outside the public traffic area. Adapt your driving style to your personal abilities and the environmental conditions. As the driver, you are solely responsible for driving your vehicle. Park your vehicle safely before operating the application.

Setting Track Race



Multimedia system:

↳ TRACK PACE ▶▶ Track Race

Recording a new track

- ▶ Select  **New track**.
- ▶ Select  **Start Record** at the desired starting point.
The track recording starts at this point.

During track recording, sectors can be set to divide up the track.

- ▶ Select  **Set Sector**.
- ▶ Select  **Stop Recording** to end track recording or cross the starting line again.
- ▶ Confirm the prompt with .
- ▶ Select the weather.

 The temperature is determined automatically.



- ▶ After ending, select  to save the track.
- ▶ Enter a name.

- ▶ Press  to confirm.
The track is saved under the name entered.

Searching by track name

- ▶ Select  **All Tracks**.
- ▶ Enter the track name.
Tracks with the searched name are displayed.



Measuring time on a saved track



- ▶ Select  **All Tracks**.
- ▶ Select the desired track.
- ▶ Select .
- ▶ Select **Start Race** if you are already stood at the starting line.

or

- ▶ Select **Navigate to** for navigation to the starting line.

Timekeeping begins automatically when the starting line has been crossed.

-  When  is selected, the track display can be switched from 2D to AR.
- ▶ Select  **Stop Race** to end timekeeping.

- ▶ Confirm the prompt with .
- ▶ Select the weather.
- ▶ Select  **Save Track** to save the times driven for this track.

Showing displays during Track Race

The following displays can be shown:

- Tire temperature
 - Mini map
 - Sector overview
 - Engine data
 - G-force display
 - Lap overview
- ▶ Select  **Start Race**.





- ▶ Select  **Setup**.
- ▶ Pull the desired display from the grid on the left or right edge of the media display. The displays are shown during the Track Race.

By selecting  on the active display, you can deactivate this.

- ▶ Select  to return to the navigation map view.

Displaying the analysis

- ▶ Select  **All Tracks** . An overview of all the driven tracks appears.
- ▶ Select a track.
- ▶ Select a session. The following data is displayed:
 - Lap and sector times
 - Average and maximum permissible speed
 - Driver

- Vehicle
- Date
- Weather
- ▶ Select **Compare to Rec.** to use a different session as a reference value.
- ▶ Select  to return to the overview.
- ▶ Select  **Diagram**.
- ▶ Set parameters  and . The analysis is displayed.





- ① Lap overview
- ② Parameter 1
- ③ Parameter 2
- ④ Trajectory of parameter 1 (e.g. time)
- ⑤ Trajectory of parameter 2 (e.g. speed)
- ⑥ The following values can be set for parameters 1 and 2, for example:
 - Speed



- Longitudinal/lateral acceleration
- Steering angle
- Engine speed
- Engine oil/tire temperature

Based on the analysis you can check and optimize driving characteristics for any position on the track.

Exporting tracks (USB)

- ▶ Select  **Tracks**.
An overview of all stored tracks appears.
- ▶ Select the desired track.
- ▶ Select options  for the desired track.
- ▶ Select **Export**.
The selected track can be exported to a USB storage device connected to the vehicle.

Editing tracks and recordings

- ▶ Select  **Tracks**.
- ▶ Select the desired track.
- ▶ Select options  for the desired track.
- ▶ Select **Rename** or **Delete**.

or



- ▶ Select a track.
- ▶ Highlight the desired recording.
- ▶ Select  options.
- ▶ Select **Export to...** or **Delete**.

Setting Drag Race

Multimedia system:

→ TRACK PACE ▶ Drag Race

Measuring acceleration

- ▶ Select  **Drag mode**.
- ▶ **Optional:** set a target speed. Measurement stops as soon as the specified target speed has been reached.
- ▶ Select  **Acceleration**.



- ▶ Pull away start the measurement. Measurement begins when the vehicle accelerates. Measurement is incremental, in steps of 30 mph (50 km/h) to a maximum of 150 mph (270 km/h).

or

- ▶ Select  **Start**. A countdown is activated. When the countdown has run out, the measurement starts. After pulling away, the reaction time is displayed. Measurement is incremental, in steps of 30 mph (50 km/h) to a maximum of 150 mph (270 km/h).

Measurement can be stopped early by selecting **Stop** or stopping the vehicle.

Quarter-mile race



- ▶  **Drag mode**
- ▶ **Optional:** set a target distance. Measurement stops as soon as the specified target distance has been reached.
- ▶ Select  **Quarter mile**.

- ▶ Pull away start the measurement. Measurement begins when the vehicle accelerates. Timing runs until the target distance or a maximum of one mile has been traveled.

or

- ▶ Select  **Start**. Timing runs until the target distance or a maximum of one mile has been traveled. Measurement can be stopped early by selecting **Stop** or stopping the vehicle.

Measuring braking

- ▶  **Drag mode**
- ▶ Select **Braking**.
- ▶ Select  **Start**. Measurement is incremental, in steps of 5 mph (10 km/h) to a standstill. If the braking procedure is started e.g. at a speed of 58 mph (157 km/h), measurement starts as soon as 55 mph (150 km/h) has been reached.

Storing and calling up measurement values

If measurement is completed or canceled, a prompt appears asking whether the measurement should be saved.

- ▶ Confirm the prompt with to save.

The stored measurements can be displayed via the [History](#) menu item.

Calling up saved measurements

- ▶ Select  [History](#).
- ▶ Select [Acceleration](#), [Quarter Mile](#) or [Braking](#).
- ▶ Select the desired measurement.
The desired measurement is displayed in detail.

or

- ▶ Delete the desired measurement.

Calling up the telemetry display

Multimedia system:

↳ [TRACK PACE](#) ▶ [Telemetry](#)

The telemetry display shows current vehicle data as a digital value and as a diagram. Up to three

parameters can be selected that are to be shown in the display.

For example:

- Engine speed
- Wheel angle
- Speed
- Steering angle

- ▶ Set the desired parameters.

- ▶ Set the time.
The set parameters are evaluated in the diagram for the time set.

- ▶  The time can range from 30 seconds to a maximum of 20 minutes.

Configuring AMG TRACK PACE

Requirements

To connect a mobile device to the TRACK PACE app:

- The TRACK PACE app is installed on the mobile end device.

- The mobile end device is connected to the multimedia system via Wi-Fi.

Multimedia system:

↳ [TRACK PACE](#) ▶ [Options](#)

Connecting a mobile device via the TRACK PACE app

The TRACK PACE app makes it possible to record videos and to synchronize them with stored tracks.

- ▶ Select [TRACK PACE App](#).
Already authorized devices are displayed in the list.
- ▶ Select [AUTHORIZE NEW DEVICE](#).
Available devices are displayed.
- ▶ Start the TRACK PACE app on the device to be connected and follow the instructions.
- ▶ Confirm the authorization prompt.
- ▶ Enter the code displayed on the device.
The device is authorized.

or

- ▶ Select a device that is already authorized.
The device is de-authorized.

Setting the TRACK PACE display in the Head-up Display

- ▶ Select [HUD Content](#).
- ▶ Activate or deactivate the desired contents.
The contents in the Head-up Display are adapted.
- ⓘ For further information on the Head-up Display, see (→ page 23).

Setting acoustic feedback

- ▶ Select [Acoustic feedback](#).
A scale with values from 0 to 85 is shown.
- ▶ Select a setting.

Flat tire

TIREFIT kit storage location

The TIREFIT kit is located under the cargo compartment floor.

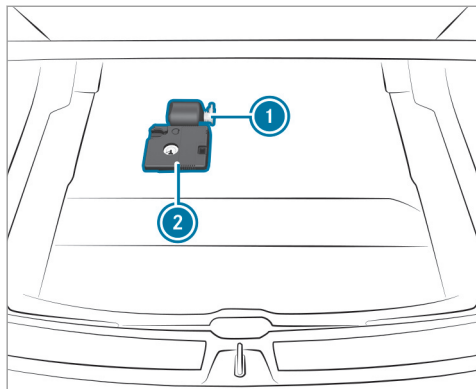

- ① Tire sealant bottle
- ② Tire inflation compressor

Overview of the tire-change tool kit

Apart from some country-specific variants, vehicles are not equipped with a tire-change tool kit. For more information on which tire-changing tools are required and approved for performing a wheel change on your vehicle, consult a qualified specialist workshop.

You require the following tools, for instance, to change a wheel:

- Jack
- Chock
- Lug wrench
- Alignment bolt

The tire-change tool kit is located in tool bag ① in the cargo compartment.

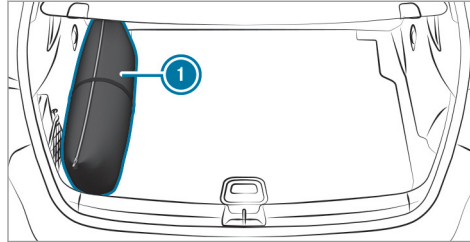

Tool bag contains:

- Jack
- Gloves
- Lug wrench
- Alignment bolt
- Folding chock
- Ratchet for jack

Setting up the folding chock

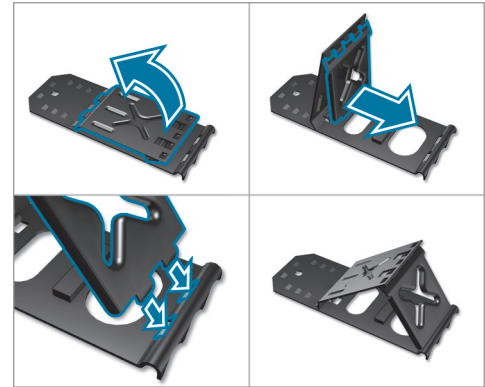

Operating fluids

Fuel

Information on fuel grades for Mercedes-AMG vehicles

Observe the information on operating fluids in the vehicle Operator's Manual.

! **NOTE** Damage caused by the wrong fuel

Even small amounts of the wrong fuel could result in damage to the fuel system, the engine and the emission control system.

- ▶ Only refuel with low-sulfur unleaded fuel.

This fuel may contain up to 10% ethanol by volume. Your vehicle is suitable for use with E10 fuel.

Never refuel with one of the following fuels:

- Diesel
- Gasoline with more than 10% ethanol by volume, e.g. E15, E85, E100

- Gasoline with more than 3% methanol by volume, e.g. M15, M30, M85, M100
- Gasoline with additives containing metal

If you have accidentally refueled with the wrong fuel:

- ▶ Do not switch the ignition on.
- ▶ Consult a qualified specialist workshop.

If the available fuel is not sufficiently low in sulfur, this can produce unpleasant odors.

Only refuel using unleaded premium grade gasoline with at least 91 AKI/95 RON.

As a temporary measure, if the recommended fuel is not available, you may also use unleaded regular gasoline which has at least the octane number specified in the information label in the fuel filler flap (see the vehicle Operator's Manual).

Never refuel using gasoline with an even lower RON.

! **NOTE** Premature wear through unleaded regular gasoline

Unleaded regular gasoline can cause the engine to wear more quickly and impair longevity and performance.

If unleaded premium grade gasoline is unavailable and you have to refuel using unleaded regular gasoline:

- ▶ Only fill the fuel tank to half full with unleaded regular gasoline and fill up as soon as possible with unleaded premium grade gasoline.
- ▶ Do not drive at the maximum design speed.
- ▶ Avoid sudden acceleration and engine speeds over 3000 rpm.

Further information on fuel is available at the following locations:

- At a gas station
- At a qualified specialist workshop
- On the <https://www.mbusa.com> (USA only)

Tank content and fuel reserve

Capacity

Model	Total capacity
Mercedes-AMG A 35 4MATIC	13.4 gal (51.0 liters)
Model	Of which reserve
Mercedes-AMG A 35 4MATIC	1.3 gal (5.0 liters)

Quality and capacity of engine oil

MB-Freigabe or MB-Approval

Model	Engine oil specifications
Mercedes-AMG A 35 4MATIC	229.51, 229.52, 229.61 229.71*

* Recommended for lowest possible fuel consumption (lowest SAE viscosity class in each

case; observe possible restrictions of the approved SAE viscosity classes).

To achieve the lowest possible fuel consumption, it is recommended to use the engine oil specifications marked in the table for the lowest SAE viscosity class. Possible restrictions of the approved SAE viscosity classes must be observed.

- ⓘ Refill oil level to the maximum before extreme driving maneuvers or using race-track mode.

The following values refer to an oil change, including the oil filter.

Capacity

Model	Capacity
Mercedes-AMG A 35 4MATIC	5.8 US qt (5.5 liters)

Coolant capacity

Capacity

Model	Capacity
Mercedes-AMG A 35 4MATIC	8.7 US qt (8.2 liters)

Refrigerant filling capacity

Missing values were not available at the time of going to press.

Filling capacity for refrigerant and PAG oil

Model	Refrigerant
Mercedes-AMG A 35 4MATIC	
Model	PAG oil
Mercedes-AMG A 35 4MATIC	

Vehicle data

Vehicle dimensions

The heights specified may vary as a result of the following factors:

- Tires
- Load
- Condition of the suspension
- Optional equipment

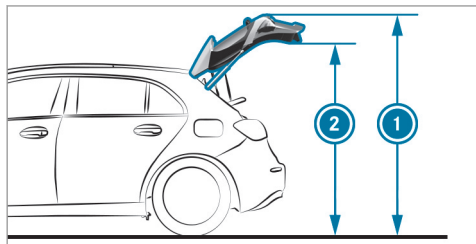

Missing values were not available at the time of going to press.

Height when opened and headroom

Model	① Height when opened	② Headroom
Mercedes-AMG A 35 4MATIC		71.2 in (1808 mm)

Vehicle dimensions

Mercedes-AMG A 35 4MATIC	
Vehicle length	174.7 in (4436 mm)
Vehicle width including outside mirrors	78.4 in (1992 mm)
Vehicle height	55.3 in (1405 mm)
Wheelbase	107.4 in (2729 mm)
Turning radius	37.86 ft (11.54 m)

Weights and loads

Please observe the following notes for the specified vehicle data:

- Items of optional equipment increase the curb weight and reduce the payload.

Roof load

Model	Maximum roof load
Mercedes-AMG A 35 4MATIC	220 lb (100 kg)



Display messages

Driving systems

Display messages	Possible causes/consequences and ► Solutions
<p>RACE START Not Possible See Operator's Manual</p>	<p>* Possible causes are:</p> <ul style="list-style-type: none"> • The conditions for activation are not met (→ page 18).
<p>RACE START Canceled</p>	<p>* Possible causes are:</p> <ul style="list-style-type: none"> • you released the accelerator pedal during RACE START. • you depressed the brake pedal during RACE START. <p>You can try RACE START again at the next start.</p>
<div data-bbox="205 560 362 643" data-label="Image"> </div> <p>Malfunction Drive at Max. 50 mph</p>	<p>* The AMG adaptive sport suspension system is malfunctioning. The vehicle's handling characteristics may be affected.</p> <ul style="list-style-type: none"> ► Do not drive at speeds greater than 50 mph (80 km/h). ► Consult a qualified specialist workshop.

Warning and indicator lamps

Driving safety systems

Warning/indicator lamp	Possible causes/consequences and ► Solutions
 <p data-bbox="144 425 389 451">ESP® OFF warning lamp</p>	<p data-bbox="454 335 1134 361">The yellow ESP® OFF warning lamp is lit while the engine is running.</p> <p data-bbox="467 368 685 394">*ESP® is deactivated.</p> <div data-bbox="482 415 1644 692" style="border: 1px solid gray; padding: 5px;"> <p data-bbox="491 422 1175 448">▲ WARNING Risk of skidding when driving with ESP® deactivated</p> <p data-bbox="495 467 1600 519">If ESP® is deactivated, ESP® cannot carry out vehicle stabilization. The availability of further driving safety systems is also limited.</p> <ul style="list-style-type: none"> <li data-bbox="495 529 713 555">▶ Drive on carefully. <li data-bbox="495 565 1110 591">▶ Only deactivate ESP® for as long as the situation requires. <p data-bbox="495 617 1021 643">If ESP® cannot be activated, ESP® is malfunctioning.</p> <ul style="list-style-type: none"> <li data-bbox="495 653 1203 679">▶ Have ESP® checked immediately at a qualified specialist workshop. </div> <p data-bbox="476 710 1055 736">▶ Observe the notes on deactivating ESP® (→ page 15).</p>
 <p data-bbox="144 845 417 871">ESP® SPORT warning lamp</p>	<p data-bbox="454 754 981 780">ESP® SPORT is activated while the engine is running.</p> <p data-bbox="467 790 1337 816">*When ESP® SPORT is activated, ESP® will stabilize the vehicle only to a limited extent.</p>

Warning/indicator lamp	Possible causes/consequences and ► Solutions
	<p data-bbox="545 256 1696 288">▲ WARNING Risk of skidding if ESP® SPORT is used incorrectly</p> <p data-bbox="545 293 1696 324">When you activate ESP® SPORT, there is an increased risk of skidding and having an accident.</p> <ul style="list-style-type: none"> <li data-bbox="545 329 1696 360">▶ Activate ESP® SPORT only in the circumstances described below. <p data-bbox="545 386 1696 417">► Observe the notes on activating ESP® SPORT(→ page 15).</p>

Driving systems

Warning/indicator lamp	Possible causes/consequences and ► Solutions
 <p data-bbox="195 653 454 679">Suspension warning lamp</p>	<p data-bbox="508 565 1206 586">The yellow AMG adaptive sport suspension system warning lamp is lit.</p> <p data-bbox="508 596 1221 617">* There is a malfunction in the AMG adaptive sport suspension system.</p> <ul style="list-style-type: none"> <li data-bbox="526 627 1045 648">► Note the messages on the multifunction display.

- A**
- Acceleration**
see Kickdown
- AMG**
Menu (on-board computer) 21
Steering wheel control element 20
Steering-wheel buttons 20
- AMG adaptive sport suspension system**
Selecting the suspension setting 19
Suspension 19
- AMG exhaust system**
Operating 12
- AMG Performance steering wheel** 20
- AMG TRACK PACE**
Configuring 28
Drag Race 27
General information 24
Telemetry display 28
Track Race 24
- Authorized Mercedes-Benz Center**
see Qualified specialist workshop
- Authorized workshop**
see Qualified specialist workshop
- Automatic engine start (ECO start/stop function)** 12
- Automatic engine stop (ECO start/stop function)** 12
- Automatic transmission**
Drive programs 13
DYNAMIC SELECT switch 13
Kickdown 14
Manual gearshifting 13
Oil temperature (on-board computer, Performance menu) 21
Steering wheel paddle shifters 13
- B**
- Boost pressure (on-board computer, Performance menu)** 21
- Brakes**
New/replaced brakepads/brake discs .. 11
Notes on breaking-in a new vehicle 11
- C**
- Changing gears** 13
Manually 13
- Chock** 31
Storage location 31
- Chock**
see Chock
- Climate control**
Filling capacity for PAG oil 33
Refrigerant filling capacity 33
- Cockpit** 4
Overview 4
- Coolant (engine)**
Capacity 33
- D**
- Dashboard**
see Cockpit
- Dealership**
see Qualified specialist workshop

Display messages

-  Malfunction Drive at Max. 50 mph 35
- RACE START Canceled 35
- RACE START Not Possible See Operator's Manual 35

Drag Race

- Setting 27

Drive programs

- see DYNAMIC SELECT

Driving safety system

- ESP® (Electronic Stability Program) 15

Driving system

- AMG adaptive sport suspension system 19

Driving tips

- Notes on breaking-in a new vehicle 11

DYNAMIC SELECT

- Drive programs 13
- Function 13

E

- E10 32

ECO start/stop function

- Automatic engine start 12
- Automatic engine stop 12
- Method of operation 12

Emotion Start

- Starting the vehicle 11

Engine

- ECO start/stop function 12

Engine oil

- Capacity 33
- MB-Freigabe or MB-Approval 33
- Quality 33
- Temperature (on-board computer, Performance menu) 21

ESP® (Electronic Stability Program)

- Activating/deactivating 17
- ESP® SPORT 15
- Function/notes 15
- Status display (on-board computer, Performance menu) 21

ESP® SPORT

- Function/notes 15

F**Fuel**

- E10 32
- Flexible fuel vehicles 32
- Fuel reserve 33
- Gasoline 32
- Quality (gasoline) 32
- Sulfur content 32
- Tank content 33

G**G-meter (on-board computer, Performance menu)**

21

Gasoline

32

Gear display (on-board computer, Performance menu)

21



Gearshift recommendation

14

Glide mode

15

H		
Head-up Display		
Function	23	
I		
Instrument display		
AMG displays	21	
J		
Jack		
Storage location	31	
K		
Kickdown	14	
Using	14	
L		
Limited Warranty		
Vehicle	9	
M		
Menu (on-board computer)		
AMG displays	21	
	Performance	21
N		
Notes on breaking-in a new vehicle	11	
O		
On-board computer		
AMG menu	21	
Performance menu	21	
Operating fluids		
Fuel (gasoline)	32	
Operating safety		
Information	7	
Operator's Manual		
Vehicle equipment	7	
P		
Performance (on-board computer, Performance menu)	21	
Power output (on-board computer, Performance menu)	21	
Q		
Qualified specialist workshop	8	
R		
RACE START		
Activating	18	
Activation conditions	18	
Function	18	
Reserve		
Fuel	33	
Roof load	34	
S		
Seat belts		
Reduced protection	10	
Selecting a gear		
see Changing gears		
Service center		
see Qualified specialist workshop		
SETUP (on-board computer, Performance menu)	21	

- Shift paddles**
see Steering wheel paddle shifters
- Shifting gears**
Gearshift recommendation 14
- Specialist workshop** 8
- Start/Stop button**
Emotion Start 11
- Start/stop function**
see ECO start/stop function
- Steering wheel paddle shifters** 13
- Sulfur content** 32
- Suspension**
AMG adaptive sport suspension system 19
Selecting the suspension setting 19
- T**
- Tank content**
Fuel 33
Reserve (fuel) 33
- Telemetry display**
Calling up 28
- Temperature**
Engine oil (on-board computer, Performance menu) 21
Transmission oil (on-board computer, Performance menu) 21
- Tire inflation compressor**
see TIREFIT kit
- Tire-change tool kit**
Overview 31
- TIREFIT kit** 30
Storage location 30
- Tool**
see Vehicle tool kit
- Torque (on-board computer, Performance menu)** 21
- Track Race**
Setting 24
- Trunk lid**
Opening dimensions 34
- V**
- Vehicle**
Correct use 9
- Equipment 7
Limited Warranty 9
Qualified specialist workshop 8
Starting (Emotion Start) 11
- Vehicle data**
Roof load 34
Turning radius 34
Vehicle height 34
Vehicle length 34
Vehicle width 34
Wheelbase 34
- Vehicle dimensions** 34
- Vehicle tool kit** 30
TIREFIT kit 30
- W**
- Warm-up (on-board computer, Performance menu)** 21
- Warning/indicator lamp**
 ESP® OFF warning lamp 36
 ESP® SPORT warning lamp 36
 Suspension warning lamp 37
- Warranty** 9

Workshop

see Qualified specialist workshop



