



S-Class

DRIVE PILOT Supplement +

Mercedes-Benz





Did you know?

To meet all needs, your Operator's Manual is available in various formats.
In addition to this PDF, the following options are open to you:





Welcome to the world of Mercedes-Benz

Before your first drive, please read this Operator's Manual carefully and familiarize yourself with your vehicle. For your own safety and a longer service life for the vehicle, follow the instructions and warnings in this Operator's Manual.

Disregarding them may lead to damage to the vehicle or injury to people.

Vehicle damage caused by failure to observe the instructions is not covered by the Mercedes-Benz Limited Warranty.

THE STANDARD EQUIPMENT AND PRODUCT DESCRIPTION OF YOUR VEHICLE MAY VARY AND DEPEND ON THE FOLLOWING FACTORS:

- Model
- Order
- National version
- Availability

In individual cases, your vehicle may therefore differ from that shown in the descriptions and illustrations.

MERCEDES-BENZ RESERVES THE RIGHT TO INTRODUCE CHANGES IN THE FOLLOWING AREAS:

- Design

- Equipment
- Technical features

THE FOLLOWING DOCUMENTS ARE COMPONENTS OF THE VEHICLE:

- Digital Operator's Manual
- Printed Operator's Manual
- Service booklet
- Supplementary manuals relating to specific equipment
- Supplementary documents

Keep these documents in the vehicle at all times. Ensure that all documents are in the vehicle or passed on in the event of sale or rental.

Mercedes-Benz USA, LLC

A Mercedes-Benz Group AG Company

**Disclaimer**

The following online version of the Operator's Manual describes all models as well as all the standard and optional equipment of your vehicle. Country-specific differences in the language variants are possible. Note that your vehicle may not be fitted with all features described. This is also the case for safety-relevant systems and functions.

Please contact your authorized Mercedes-Benz dealer if you would like to have a printed Operator's Manual for other vehicle models and vehicle model years. The online version is the currently valid Operator's Manual. Possible variations to your vehicle may not be taken into account because Mercedes-Benz is constantly updating its vehicles and equipment in line with the current state of the art and introducing changes to the design and equipment.

Please also read the printed Operator's Manual, any supplementary documents and the digital Operator's Manual in the vehicle.

COPYRIGHT

All Rights Reserved. All texts, images, graphics, are subject to Copyright and other laws for the protection of intellectual property. They may not be copied for commercial purposes or for transmission, nor changed and used on other websites.



Contents

This interactive PDF works like a website – tap or click a button to jump straight to where you want to go. You can return here at any time via the navigation bar at the top left.

Symbols >

General notes >

Driving and parking >

Maintenance and care >

Display messages and warning/indicator lamps >

Index >



< Symbols

This interactive PDF works like a website – tap or click a button to jump straight to where you want to go. You can return here at any time via the navigation bar at the top left.



In this Operator's Manual, you will find the following symbols:

WARNING

Danger due to not observing the warning notices

Warning notices draw your attention to hazards that may endanger your health or life, or the health or life of others.

-  Observe and obey the warning notices.

ENVIRONMENTAL NOTE

Environmental damage due to failure to observe environmental notes

Environmental notes include information on environmentally responsible behavior or environmentally responsible disposal.

-  Observe environmental notes.

NOTE

Damage to property due to failure to observe notes on material damage

Notes on material damage inform you of risks which may lead to your vehicle being damaged.

-  Observe notes on material damage.

 These symbols indicate useful instructions or further information that could be helpful to you.



Instruction

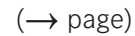

Further information on a topic



Indicator on the central display



Highest menu level which is to be selected in the multimedia system



Relevant submenus which are to be selected in the multimedia system

*

Indicates a cause





< General notes

This interactive PDF works like a website – tap or click a button to jump straight to where you want to go. You can return here at any time via the navigation bar at the top left.

Operator's Manual >

Country-specific information >

Data processing in vehicles with DRIVE
PILOT >

Event data recorder for vehicles with
DRIVE PILOT >



< Operator's Manual

This supplement provides information pertaining to all important functions of your vehicle with DRIVE PILOT that is either not included in, or deviates from, the information provided in your vehicle Operator's Manual. This information supplements or replaces the corresponding sections in the vehicle Operator's Manual. Under no circumstances does the supplement replace the printed vehicle Operator's Manual and the Digital Operator's Manual in the vehicle.

THIS SUPPLEMENT AND THE DIGITAL OPERATOR'S MANUAL IN THE VEHICLE DESCRIBE THE FOLLOWING MODELS AND THE STANDARD AND SPECIAL EQUIPMENT OF YOUR VEHICLE:

- The models and the standard and special equipment available at the time of this supplement going to press.
- The models and the standard and special equipment only available in certain countries.
- The models and the standard and special equipment which will only become available at a later date.

Please note that your vehicle may not be installed with all features described. This also applies to systems relevant to safety. The equipment on your vehicle may therefore differ from that in the descriptions and illustrations.

The original purchase agreement for your vehicle includes a list of the equipment in your vehicle at the time of delivery.

Should you have any questions concerning equipment and operation, please consult an authorized Mercedes-Benz Center.

The Operator's Manual, supplements, further supplementary documents and maintenance booklet are important documents and should be kept in the vehicle.





< Country-specific information

Vehicles with DRIVE PILOT are not approved in all federal states of the USA and not in all countries or regions outside the USA. Please note that driving vehicles with the DRIVE PILOT equipment may not be legally permitted in these countries or regions. This may even apply even if the DRIVE PILOT function is deactivated when the vehicle is in use.

Please also observe the current laws of the country or region in which you are located.

You can find further information on countries or regions outside the USA on www.mbusa.com.





< Data processing in vehicles with DRIVE PILOT

Please observe the vehicle's general notes on data processing in the Operator's Manual. Regarding the manufacturer's online services, the individual functions are described by the manufacturer in a suitable place – foreexample, the Operator's Manual, the website – along with the relevant data protection information.

In accordance with the legal requirements of the respective country, vehicles with DRIVE PILOT store additional data in the vehicle.

FOR EXAMPLE, THE TIME IS STORED IN THE FOLLOWING CASES:

- in the event of a change in vehicle control between the driver and the system
- in the event of a prompt to reassume control of the vehicle

This additional data is only stored in the vehicle and is not sent to the manufacturer.

The data in the data memory can be read out at the request of the owner or the legally authorised person at a qualified specialist workshop. The workshop will provide the vehicle owner with the data read out.

An obligation to read out, pass on, or store the data may result from the legal requirements of the respective country or region. When duly justified, the vehicle owner must pass on this data to a legally authorised group of persons, for example to the authorities. This group of persons can demand that the vehicle owner hand over the data in accordance with the legal requirements and process the data read out.

The storage period of the data in the vehicle is limited. It is based on the legal regulations of the country or region in which the vehicle was in operation at the time of using DRIVE PILOT.





< Event data recorder for vehicles with DRIVE PILOT

This vehicle is equipped with an automated driving system data recorder (ADS EDR), in addition to the event data recorder (EDR). The main purpose of this data recorder is to record sensor data, in certain crash or near crash-like situations during conditionally automated driving that will assist in understanding the system behavior. This data can help provide a better understanding of the circumstances in which accidents and injuries occur.

To read data recorded by an ADS EDR, a commercially available tool is required and access to the vehicle is needed. In addition to the vehicle manufacturer, other parties that have the special equipment, such as law enforcement, can read the information by accessing the vehicle or the ADS EDR. Damage or destruction of the ADS EDR (e.g. after removal of the Intelligent Drive Controller at a workshop) may lead to the damage or eradication of the data recorded on the ADS EDR.





◀ Driving and parking

This interactive PDF works like a website – tap or click a button to jump straight to where you want to go. You can return here at any time via the navigation bar at the top left.

Driving and driving safety systems





< Driving and driving safety systems

Information on vehicle sensors and cameras

DRIVE PILOT monitors the vehicle surroundings using cameras and sensors.

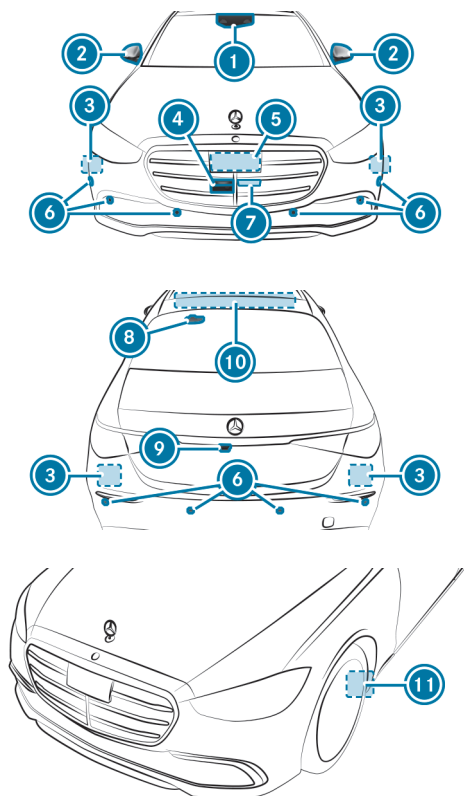

- ① Multifunction camera, front
- ② Cameras in the exterior mirrors
- ③ Corner radars
- ④ Front camera
- ⑤ Front radar
- ⑥ Ultrasonic sensors
- ⑦ Lidar sensor
- ⑧ Rear multifunction camera
- ⑨ Rear view camera
- ⑩ Antenna module
- ⑪ Moisture sensor







WARNING

Risk of accident due to restricted detection performance of vehicle sensors and cameras

Certain driving and safety systems cannot function correctly if vehicle sensors or cameras are obstructed or dirty.

-  In order to maximize DRIVE PILOT availability and safe operation, keep the area around sensors and cameras clean and clear of obstruction.
-  Repair damage to the bumper, radiator grille or stone chipping in the area of the front and rear windows at a qualified specialist workshop.

In particular, keep the sensor and camera areas free of dirt, ice or slush. The sensors and cameras must not be covered and the detection ranges around them must be kept free. Do not attach additional license plate brackets, advertisements, stickers, car foils or rock chip protection films in the detection range of the sensors and cameras. Make sure there are no overhanging loads protruding into the detection range.

Do not use DRIVE PILOT if you are towing someone or pulling a trailer. This can result in the sensors and cameras being covered, which restricts their detection performance.

If there is damage to a bumper or the radiator grill, or after an impact, have the function of the sensors checked at a qualified specialist workshop. Have repair damage or stone chipping in the area of the cameras on the front and rear windows at a qualified specialist workshop.



-  The rear view camera can extend and retract automatically for the purpose of calibration, even though there is no camera image on the display.

NOTES ON THE LIDAR SENSOR

WARNING

Risk of injury due to the lidar sensor's laser beams

This product uses a class 1 laser system. If the housing is opened or damaged, laser radiation may damage your retina.

-  Do not remove or open the housing of the lidar sensor.
-  If there is damage to the housing, do not look into the housing, and consult a qualified specialist workshop immediately.
-  Always have all maintenance work and repairs carried out by a qualified specialist workshop.

This device is a class 1 laser product in accordance with IEC 60825-1:2014.

The lidar sensor is heated and has an automatic cleaning unit. More severe soiling must be removed by hand if necessary. Observe the notes on the cleaning and care of vehicle parts.

DRIVE PILOT

FUNCTION OF DRIVE PILOT

The DRIVE PILOT function enables conditionally automated driving on divided highways with at least two lanes at speeds of up to 40 mph (65 km/h).





i Please note that DRIVE PILOT is not approved in all countries or regions. Please also observe the applicable legislation of the country or region in which you are located. DRIVE PILOT is not available on all roads or in all states. The availability of DRIVE PILOT on the established route network is subject to change without notice. For more information, please visit the Mercedes-Benz USA homepage.

i DRIVE PILOT is available only in conjunction with the required services. These are required to retrieve up-to-date traffic and map data, etc..

The DRIVE PILOT follows its own lane in heavy traffic and adapts its speed to the flow of traffic. The system regulates the distance to the vehicle in front depending on the speed being driven. The maximum permissible speed, regardless of traffic, is shown on the driver display.

The system analyzes and automatically takes into account the route, route events ahead, and traffic signs.

i You cannot manually adjust the speed and distance to the vehicle ahead when the DRIVE PILOT is active.

DRIVE PILOT can also detect and react to numerous critical traffic situations. If, for example, a vehicle pulls in at a short distance from the front of your vehicle, DRIVE PILOT will decelerate or swerve within the lane.

In rare cases, DRIVE PILOT may not react to contact from other road users and thus may not prompt the fallback ready user to take control. Information on takeover request

If a "move over law" situation is detected, DRIVE PILOT can reduce speed and/or move the vehicle from the center of the lane toward the edge of the lane.

The DRIVE PILOT cannot change lanes or overtake other vehicles of its own accord. A manual lane change terminates the DRIVE PILOT. As soon as all conditions are met again, you can reactivate the DRIVE PILOT.

Manual intervention by the driver may deactivate DRIVE PILOT or trigger a takeover request, depending on the manner and magnitude of the intervention. As soon as the driver steers, accelerates or brakes, the responsibility for driving and safe operation of the vehicle, including compliance with traffic regulations, will be returned to the driver.

STATUS INDICATOR ON THE STEERING WHEEL

The colors of the status lights on the steering wheel indicate the operating status of DRIVE PILOT. Therefore, always observe the lights displayed and be prepared to take over when DRIVE PILOT is active. Pay particular attention to the instructions for safe use of DRIVE PILOT.

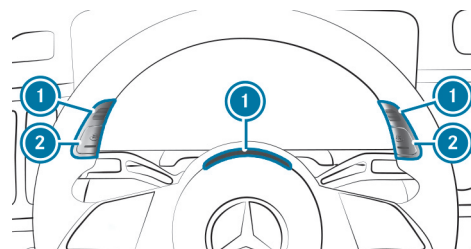

- ① Status lights
- ② Indicator lights on the buttons

STATUS LIGHT COLORS ①

- **Pulsating turquoise:** The DRIVE PILOT is requested.
- **Glowing turquoise:** The DRIVE PILOT is active.





- **Flashing turquoise:** The DRIVE PILOT is switched off by the driver.
- **Yellow:** The roadway approved for the DRIVE PILOT ends soon.
- **Pulsating red:** Prompt to reassume control of the vehicle or cancellation of activation.

COLOR OF THE INDICATOR LIGHTS ON THE BUTTONS ②

- White: DRIVE PILOT is available.

STATUS DISPLAY ON THE DRIVER DISPLAY



- ① Permanent status display
- ② Current maximum speed set by the system
- ③ Maximum remaining distance to an event that restricts the functioning of the DRIVE PILOT, e.g. tunnels or ineligible sections
- ④ Availability display

As soon as the availability display ④ appears, the DRIVE PILOT is ready for operation. The status display ① pulsates when the DRIVE PILOT is activated, and lights up continuously while the DRIVE PILOT is active.

DISPLAY IN THE ASSISTANCE MENU

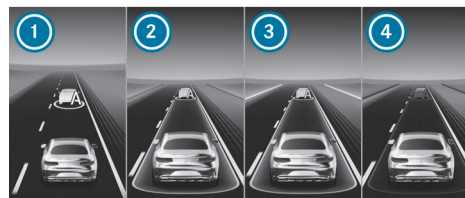

- ① DRIVE PILOT is available: The vehicle ahead is within the appropriate distance and speed range.
- ② DRIVE PILOT is active: The vehicle ahead and the area between your own vehicle and the vehicle ahead, as well as the edges of the roadway, are highlighted in turquoise.
- ③ Availability of DRIVE PILOT will end soon: the roadway edges are highlighted in yellow. The area between your own vehicle and the vehicle in front remains displayed in turquoise.
- ④ Prompt to assume control of the vehicle: The area between your own vehicle and the vehicle in front is highlighted in red.

NOTES ON SAFE USE OF THE DRIVE PILOT

The person in the driver's seat when DRIVE PILOT is activated is designated as the fallback-ready user and should be ready to take over control of the vehicle. The fallback-ready user must always be able to take control of the vehicle when prompted by the system.



**⚠ WARNING**

Risk of accident due to other road users

DRIVE PILOT cannot always prevent the risk of an accident, particularly if the risk comes from other road users. Despite a brake application or steering intervention, a collision cannot always be prevented.

- ▶ Remain receptive: Pay attention to information and messages; take over control of vehicle when requested to do so.
- ▶ Take control of the vehicle if evident irregularities concerning performance relevant system failures are detected in the vehicle.
- ▶ Always ensure that all vehicle occupants have their seat belts fastened correctly and are sitting properly.
- ▶ Do not stow, attach or keep any objects on the steering wheel, on the instrument panel or in the deployment area of the air-bag.
- ▶ Stow loose objects safely.

⚠ WARNING

Risk of accident due to lack of readiness or ability to take over control by the fallback-ready user.

The fallback-ready user, when prompted by the system, must be ready to take control of the vehicle immediately.

DRIVE PILOT does not relieve you of your responsibilities beyond the dynamic driving task when using public roads.

- ▶ Remain receptive: Pay attention to information and messages; take over control of the vehicle when requested to do so.
- ▶ Take over control of the vehicle if irregularities are detected aside from the dynamic driving task.
- ▶ Always maintain a correct seating position and keep your seat belt fastened. In particular, the steering wheel and pedals must be within easy reach at all times.
- ▶ Always ensure you have a clear view, use windshield wipers and the airconditioning system defrost function if necessary.
- ▶ Ensure appropriate correct lighting of the vehicle, e.g. in fog.







WARNING

Risk of injury from objects in the deployment area of an airbag

Objects in the deployment area of an airbag can hinder or prevent the correct deployment of the airbag.

The airbag may then deploy in an uncontrolled manner and may even cause additional injuries to the vehicle occupants by deploying. This may be the case in particular if the airbag is integrated into the seat.

-  Always stow and secure objects correctly.
-  Before commencing your journey, make sure that no objects are stowed in the deployment area of an airbag.

EVEN WHEN DRIVE PILOT IS ACTIVE, PARTICULAR ATTENTION SHOULD BE PAID TO THE FOLLOWING INSTRUCTIONS:

- Take regular and timely breaks on long journeys. When DRIVE PILOT is not activated, the person in the driver's seat is responsible for the safe operation of the vehicle.
- If you steer, brake or accelerate yourself when DRIVE PILOT is active, DRIVE PILOT may be deactivated, depending on the manner and magnitude of the intervention. This will also apply should you move the steering wheel unintentionally. Therefore, be careful not to intervene in the vehicle control system by mistake.
- Observe all chapters of the Operator's Manual for your vehicle, especially the information in the chapters "Occupant safety" and "Seats and stowage".

When the DRIVE PILOT is active, you can use the driving time effectively, taking into account the previous instructions. The information and communication systems integrated in the vehicle are particularly suitable for this purpose, and

are easily negotiated from the control elements on the steering wheel and on the central display.

THESE INCLUDE, FOR EXAMPLE, THE FOLLOWING FUNCTIONS:

- Playing videos on the central display
- Use of in-vehicle communication devices via the multimedia system
- Use of advanced In-Car Office functions

 Availability of individual functions will depend on the respective equipment. Due to differing legal regulations, certain functions may be deactivated when the DRIVE PILOT is active, depending on the country in which you are currently located.

 Always observe the country and state specific legislation. Please note, the use of mobile devices is not permitted in some states even when DRIVE PILOT is active.

SYSTEM LIMITS

If DRIVE PILOT detects a system limit or any of the conditions for activation are not met, it will not be possible to activate the system or the fallback-ready user will be prompted to take control of the vehicle immediately.

DRIVE PILOT MAY BE UNAVAILABLE IN THE FOLLOWING SITUATIONS IN PARTICULAR:

- The sensors or cameras are obscured, dirty or damaged.
- The driver camera cannot capture the driver's eyes or parts of the face.
- The driver is wearing extremely dark or polarized sunglasses, or glasses with infrared protection lenses.
- The navigation system is not operational.







- There is a hazard warning in the navigation system.
- The section of roadway ahead is unsuitable, e.g. has no lane markings, is too narrow, or is not approved for the use of DRIVE PILOT.
- A driving safety system, e.g. ESP®, issues a warning or intervenes.
- A relevant warning lamp is on or a relevant warning message is displayed. Observe the indicators on the driver display.
- The system has detected a construction site ahead.
- The system has detected a tunnel ahead.
- The system has detected an unusual traffic situation, e.g. an accident or other obstacle on the roadway.
- The system has detected one or more pedestrians on or close to the lane.
- Weather conditions do not permit use of DRIVE PILOT, e.g. in darkness, low outside temperatures, or precipitation.
- The system detects an approaching or stationary emergency vehicle with the siren or emergency lights switched on.
- A roof luggage rack is being used.
- The outside mirrors are folded in.
- High beam or rear fog lights are switched on.
- The diagnostics connection is being used.
- The hazard warning light remains switched on for a certain period of time.
- The system has detected a towing operation.

OPERATING DRIVE PILOT

Requirements:

- The required Mercedes me connect services have been activated and the mobile phone and internet connection is established.
- You are driving on a freeway that is approved for use of the DRIVE PILOT.

- The current driving speed does not exceed the maximum permissible speed of the DRIVE PILOT.
- Adequate distance to the vehicle in front: if necessary, DRIVE PILOT can adjust the distance to the prescribed setting during activation. In this case, the distance may neither be too short nor too great.
- Range of the vehicle is sufficient.
- The driver camera is switched on and detects the head and both eyes of the driver.
- You do not accelerate too intensely and you do not brake.
- No significant movements of the steering wheel.
- The light switch is in position **AUTO** or .
- The windshield wiper is set to automatic wiping.
- There is enough washer fluid in the windshield washer system.
- The hood and trunk lid are closed.
- The system limits are observed (→ page 16).

 Some of the requirements can also be fulfilled during the activation process.

ACTIVATING DRIVE PILOT

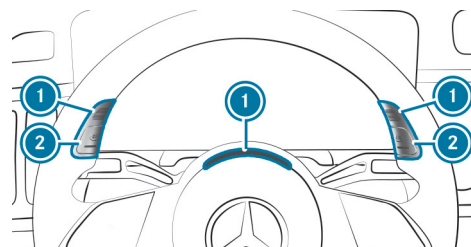





When the indicator lamps on buttons ② light up white: DRIVE PILOT is available.

▶ Press one or both buttons ②.

When the status lights ① pulsate turquoise: The DRIVE PILOT is requested.

It may take a few seconds until all requirements for activation are met and the appropriate speed and sufficient distance to the vehicle in front are established. Please also note the information on the driver display. The driver is responsible for driving the vehicle up until the DRIVE PILOT is activated.

When status lights ① light up permanently in turquoise: DRIVE PILOT is active. The  drive program is selected and climate control is regulated automatically.

 Mercedes-AMG vehicles: DRIVE PILOT is available in all drive programs.

▶ Observe the message shown on the driver display and confirm with the  button on the steering wheel.

If all requirements for activating the DRIVE PILOT are not met within a certain time, it cannot be activated. The status lights ① pulsate red and a warning tone sounds.

When the indicator lights on the buttons ② light up white again, the DRIVE PILOT can be requested again. If the activation process is abruptly interrupted, the driver must resume command of the driving task at hand.

If the indicator lights on the buttons ② do not light up white and you press one or both of the buttons ②, a message appears on the driver display indicating why the DRIVE PILOT is currently not ready for operation.

DEACTIVATING DRIVE PILOT

 You can assume control of the vehicle and continue driving manually at any time, e.g. to overtake a vehicle ahead or to exit the freeway. As soon as you steer, accelerate or brake, the DRIVE PILOT is deactivated or prompts you to reassume control of the vehicle, depending on the manner and magnitude of intervention.

▶ Press one or both buttons ②.

The status lights ① flash turquoise: The DRIVE PILOT is deactivated.

▶ Take full control of the vehicle:

- Keep your eyes on the roadway and gather your bearings.
- Put your hands on the steering wheel.
- Steer, brake or accelerate as needed or press one of the two buttons ②.
- Ensure safe operation of the vehicle and compliance with traffic regulations.

The message **DRIVE PILOT Off** appears on the driver display.

 After deactivating the DRIVE PILOT, Active Brake Assist, Active Lane Keeping Assist and Active Blind Spot Assist are automatically activated, even if they were deactivated before using the DRIVE PILOT.





- i** If Active Distance Assist DISTRONIC is preselected and Active Steering Assist is switched on, this will be activated following deactivation of DRIVE PILOT, as long as all requirements are fulfilled.

TAKEOVER REQUEST

IF DRIVE PILOT DETECTS A SYSTEM LIMIT OR IF ALL CONDITIONS ARE NO LONGER MET, THE FALLBACK-READY USER WILL BE PROMPTED TO TAKE CONTROL OF THE VEHICLE IMMEDIATELY WHILE PAYING ATTENTION TO THE VEHICLE'S SURROUNDINGS:

- The status lights **1** pulsate red and an intermittent warning tone sounds.
 - The  **Take full control of vehicle!** message is displayed.
- ▶ Take full control of the vehicle:
- Keep your eyes on the roadway and gather your bearings.
 - Put your hands on the steering wheel.
 - Steer, brake or accelerate as needed, or press one of the two buttons **2**.
 - Ensure safe operation of the vehicle and compliance with traffic regulations.

The message **DRIVE PILOT Off** appears on the driver display.

- ▶ **Or:** Deactivate the DRIVE PILOT by pressing one of the two buttons **2**.

If the fallback-ready user does not respond to the takeover request, the frequency of the warning tones will increase. The fallback-ready user will also be warned by the seatbelt Emergency Tensioning Device. If the fallback-ready

user still does not react within the maximum allotted time of ten seconds, a warning will be given by brief brake application, the hazard warning light system will be activated and the vehicle will be braked to a standstill.

The  **Take full control of vehicle! Emergency stop initiated** message appears on the driver display.

WHEN THE VEHICLE HAS COME TO A STANDSTILL:

- the vehicle is secured with the electric parking brake.
- the vehicle is unlocked.
- if possible, an emergency call is made to the Mercedes-Benz emergency call center.

Once initiated, an emergency stop can be canceled if the fallback-ready user takes control of the vehicle.

IF DRIVE PILOT DETECTS AN UPCOMING ROUTE EVENT THAT REQUIRES THE FALLBACK-READY USER TO TAKE OVER, THE FALLBACK-READY USER CAN BE WARNED IN ADVANCE:

- Status lights **1** will remain lit up in turquoise and a corresponding message will appear on the driver display. DRIVE PILOT will indicate a route event ahead that requires the driver to take manual control.

When the vehicle approaches the detected route event ahead, status lights **1** will initially light up yellow and the remaining distance to the route event ahead will be shown in yellow on the driver display.

- ▶ Prepare to take over the vehicle, paying attention to the surroundings and traffic.



If the fallback-ready user does not react, status lights **1** will flash red after some time.





An intermediate warning tone sounds and the  **Take full control of vehicle!** message appears.

Once the driver has assumed control of the vehicle, the **DRIVE PILOT Off** message appears.

 As soon as DRIVE PILOT becomes available once manual command of the vehicle is resumed, the indicator lights on the buttons  light up white again. The DRIVE PILOT can be activated again.

PRE-ACTIVATING DRIVE PILOT IN THE MULTIMEDIA SYSTEM

Multimedia system:

   **Settings**  **Assistance**  **Driving**

 Pre-activate or deactivate the function.





< Maintenance and care

This interactive PDF works like a website – tap or click a button to jump straight to where you want to go. You can return here at any time via the navigation bar at the top left.

Cleaning and care





< Cleaning and care

Notes on car parts cleaning and care

Observe the following notes in order to prevent damage to the vehicle and to maximize DRIVE PILOT availability:

SENSORS

- Clean the sensors in the front and rear part of the vehicles with vehicle shampoo, plenty of water and a soft cloth.
- When using a power washer, maintain a minimum distance of 11.8 in (30 cm).

i Keep the front lens of the lidar sensor free of scratches. Otherwise, driving systems and driving safety systems may be impaired or not available (→ page 15).

CAMERAS

- Use clean water and a soft cloth to clean the camera lenses.
- Do not use a power washer.

i Remove external misting or dirt on the windshield or rear window in front of the multifunction camera. Otherwise, driving systems and driving safety systems may be impaired or not available (→ page 15).





< Display messages and warning/indicator lamps

This interactive PDF works like a website – tap or click a button to jump straight to where you want to go. You can return here at any time via the navigation bar at the top left.

[Driving and driving safety systems](#)





< Driving and driving safety systems

Display messages	Possible causes/consequences and ► Solutions
DRIVE PILOT Currently Unavailable See Operator's Manual	<p>* DRIVE PILOT is temporarily unavailable.</p> <p>The ambient conditions are outside the system limits (→ page 16).</p> <ul style="list-style-type: none"> ► Drive on <p>or</p> <ul style="list-style-type: none"> ► If the display message does not disappear, stop the vehicle in accordance with the traffic conditions and restart the vehicle.
DRIVE PILOT Inoperative See Operator's Manual	<p>* DRIVE PILOT is not available.</p> <ul style="list-style-type: none"> ► Drive on <p>or</p> <ul style="list-style-type: none"> ► Stop the vehicle in accordance with the traffic conditions and restart the vehicle. ► If the display message does not disappear: consult a qualified specialist workshop.
DRIVE PILOT Cannot Be Activated ...	<p>* DRIVE PILOT is not available because system limits were detected or not all requirements for the function have been fulfilled (→ page 16).</p>
 <p>DRIVE PILOT Could Not Be Activated ...</p>	<p>* DRIVE PILOT is not available because system limits were detected or not all requirements for the function have been fulfilled(→ page 16).</p> <p>* DRIVE PILOT is not available as a collision was detected.</p> <p>Have the vehicle checked immediately at a qualified specialist workshop.</p>
DRIVE PILOT Off ...	<p>* DRIVE PILOT is no longer available because system limits were detected or not all requirements for the function have been fulfilled (→ page 16).</p>





Display messages

Possible causes/consequences and Solutions



Take full control of vehicle!

* DRIVE PILOT has reached its system limits (→ page 16).

- ▶ Take full control of the vehicle:
 - Keep your eyes on the roadway and gather your bearings.
 - Put your hands on the steering wheel.
 - Steer, brake or accelerate as necessary, or press one of the two buttons on the steering wheel.
 - Ensure safe operation of the vehicle and compliance with traffic regulations.

The **DRIVE PILOT Off** message appears on the driver's display.

Notes on deactivation and the prompt to take control (→ page 21).

DRIVE PILOT Will Be Available Again After Restarting the Engine

* DRIVE PILOT is temporarily unavailable due to an emergency stop.

- ▶ Drive on
- ▶ Stop the vehicle in accordance with the traffic conditions and restart the vehicle.

DRIVE PILOT Only with Clear Windows Please Adjust Air Conditioning Setting

* The DRIVE PILOT function is impaired due to the windshield fogging up.

- ▶ To clear the fog on the windows, adjust the climate control settings:
 - Defrosting the windshield
 - Increase the temperature
 - Increase the airflow

DRIVE PILOT Steering Wheel and Pedals Must Be Within Reach

* The driver's seat position is not set correctly for the DRIVE PILOT function. It must be possible to reach the steering wheel and pedals at all times.

- ▶ Set the driver's seat position correctly to enable you to take control of the vehicle at any time.





Display messages

Possible causes/consequences and ► Solutions

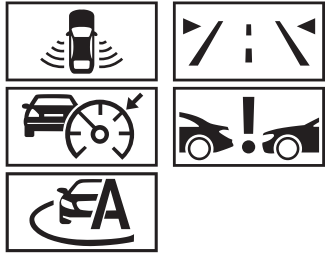

Temporarily Unavailable Sensors Dirty

* **FRONT AND CORNER RADAR SENSORS AND/OR LIDAR (HEREAFTER "SENSORS") ARE NOT OPERATIONAL. POSSIBLE CAUSES ARE:**

- The sensors are dirty or damaged
- Heavy rain or snow
- Extended country driving without other traffic, e.g. in the desert

Driving systems and driving safety systems may be not operational or temporarily unavailable. The brake system, steering and drive system will continue to function normally.

- Drive on carefully.

Once the causes of the problem are no longer present, the driving systems and driving safety systems will be available again and the corresponding symbols will be switched off.

If the display message does not disappear:

- Stop the vehicle in accordance with the traffic conditions.
- Clean all sensor covers from the outside and check for damage (→ page 15).
- Restart the vehicle.

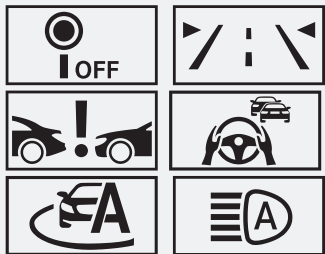

Camera View Reduced See Operator's Manual

* **THE VIEW OF THE MULTIFUNCTION CAMERA IS RESTRICTED. POSSIBLE CAUSES:**

- Dirt on the windshield in the field of vision of the multifunction camera
- Heavy rain, snow or fog
- Mist on the inside or outside of the windshield: in certain weather conditions, mist can form on the inside or outside of the windshield during cold times of year in particular.

i This mist on the windshield will be removed automatically within a short time with the aid of a heater. The restriction is temporary.





Display messages

Possible causes/consequences and Solutions

Driving systems and driving safety systems may be not operational or temporarily unavailable. The brake system, steering and drive system will continue to function normally.

- ▶ Drive on carefully.
- ▶ To remove the mist from the outside, wipe once.
- ▶ To remove the mist from the inside, press  .

Once the causes of the problem are no longer present, the driving systems and driving safety systems will be available again and the corresponding symbols will be switched off.

If the display message does not disappear even after a driving time of about 15 minutes:

- ▶ Stop the vehicle in accordance with the traffic conditions.
- ▶ Clean the windshield, especially in the position of the multifunction camera (→ page 15).
- ▶ Restart the vehicle.





< Index

Searching for something specific? Click on the relevant initial letter here and look it up. Incidentally, you can also use your PDF reader's search function at any time.

[C](#) >

[V](#) >

[D](#) >

[E](#) >

[F](#) >

[O](#) >

[R](#) >

[S](#) >



< C

Camera

Information >

Cameras

Care >

Cleaning >

Care

Cameras >

Sensors >

Cleaning

Cameras >

Sensors >



< D

Data storage

DRIVE PILOT >

Event Data Recorder >

Display messages

Camera View Reduced See Operator's Manual >

DRIVE PILOT Could Not Be Activated ... >

Take full control of vehicle! >

Temporarily Unavailable Sensors Dirty >

DRIVE PILOT Cannot Be Activated ... >

DRIVE PILOT Currently Unavailable See Operator's Manual >

DRIVE PILOT Inoperative See Operator's Manual >

DRIVE PILOT Off ... >

DRIVE PILOT Only with Clear Windows Please Adjust Air Conditioning Setting >

DRIVE PILOT Steering Wheel and Pedals Must Be Within Reach >

DRIVE PILOT Will Be Available Again After Restarting the Engine >

DRIVE PILOT

Activating/deactivating >

Country-specific information >

Function >

Operating >

Driving safety system

Cameras >

Radar and ultrasonic sensors >



< E

Event Data Recorder





< F

Film coverings

On camera/sensors



Foil covering

Radar and ultrasonic sensors





< 0

Operator's manual





< R

Radar and ultrasonic sensors





< S

Sensors

Care >

Cleaning >

Information >



< V

Vehicle

Data storage DRIVE PILOT	>
Equipment	>

Vehicle sensors

Care	>
Cleaning	>

Vehicle cameras

Care	>
Cleaning	>

Vehicle equipment





Publication details

WEBSITE

Further information about Mercedes-Benz vehicles and about Mercedes-Benz AG can be found on the following websites:

<https://www.mbusa.com>

EDITORIAL TEAM

© Mercedes-Benz AG: Not to be reprinted, translated or otherwise reproduced, in whole or in part, without written permission from Mercedes-Benz AG.

VEHICLE MANUFACTURER

Mercedes-Benz AG

Mercedesstraße 120

70372 Stuttgart, Germany