





## Your Operator's Manual

-  **Digital form inside the vehicle**  
Familiarize yourself with the contents of the Operator's Manual directly via your vehicle's multimedia system (Menu item "Vehicle").
-  **Booklet inside the vehicle**  
In addition to the vehicle's Operator's Manual, you can obtain the complete multimedia system Supplement from your authorized Mercedes-Benz Center.
-  **Digital form via the Internet**  
You can find the Operator's Manual on the Mercedes-Benz homepage.
-  **Digital form as an App**  
The Mercedes-Benz Guides App is available for free on the Apple® App store or Google Play.

Apple® iOS



Android™



# SL

Operator's Manual



2315846102

Order no. P231 0181 13 Part no. 231 584 61 02 Edition B2019

SL Operator's Manual

Mercedes-Benz



## Symbols

Registered trademarks:

- Bluetooth® is a registered trademark of Bluetooth SIG Inc.
- DTS™ is a registered trademark of DTS, Inc.
- Dolby® and MLP™ are registered trademarks of DOLBY Laboratories.
- BabySmart™, ESP® and PRE-SAFE® are registered trademarks of Daimler AG.
- HomeLink® is a registered trademark of Johnson Controls.
- iPod® and iTunes® are registered trademarks of Apple Inc.
- Logic 7® is a registered trademark of Harman International Industries.
- Microsoft® and Windows media® are registered trademarks of Microsoft Corporation.
- SIRIUS® is a registered trademark of Sirius XM Radio Inc.
- HD Radio™ is a registered trademark of iBiquity Digital Corporation.
- Gracenote® is a registered trademark of Gracenote, Inc.
- ZAGAT Survey® and related brands are registered trademarks of Zagat Survey, LLC.

In this Operator's Manual you will find the following symbols:

### **WARNING**

Warning notes make you aware of dangers which could pose a threat to your health or life, or to the health and life of others.

### **Environmental note**

Environmental notes provide you with information on environmentally aware actions or disposal.

 Notes on material damage alert you to dangers that could lead to damage to your vehicle.

 Practical tips or further information that could be helpful to you.

- ▶ This symbol indicates an instruction that must be followed.
- ▶ Several of these symbols in succession indicate an instruction with several steps.

 This symbol tells you where you can find more information about a topic.

 This symbol indicates a warning or an instruction that is continued on the next page.

**Display** This text indicates a message on the multifunction display/multimedia display.



Example

### **WARNING**

If the front passenger air bag has been activated, a child on the front passenger seat may be hit by the front passenger air bag in the event of an accident. There is a risk of injury or fatal injury.

NEVER use a rearward-facing child restraint system on a seat protected by an ACTIVE FRONT AIRBAG; DEATH or SERIOUS INJURY to the CHILD can occur.

Read the chapter "Children in the vehicle" .

## Publication details

### Internet

Further information about Mercedes-Benz vehicles and about Daimler AG can be found on the following websites:

<http://www.mbusa.com> (USA only)

<http://www.mercedes-benz.ca> (Canada only)

### Editorial office

©Daimler AG: not to be reprinted, translated or otherwise reproduced, in whole or in part, without written permission from Daimler AG.

### Vehicle manufacturer

Daimler AG  
Mercedesstraße 137  
70327 Stuttgart  
Germany



## Welcome to the world of Mercedes-Benz

We urge you to read this Operator's Manual carefully and familiarize yourself with the vehicle before driving. For your own safety and a longer vehicle life, follow the instructions and warning notices in this manual. Ignoring them could result in damage to the vehicle or personal injury to you or others.

Vehicle damage caused by failure to follow instructions is not covered by the Mercedes-Benz Limited Warranty.

The equipment or product designation of your vehicle may vary depending on:

- Model
- Order
- Country specification
- Availability

Mercedes-Benz therefore reserves the right to introduce changes in the following areas:

- Design
- Equipment
- Technical features

The equipment in your vehicle may therefore differ from that shown in the descriptions and illustrations.

The following are integral components of the vehicle:

- Digital Operator's Manual
- Printed Operator's Manual
- Maintenance Booklet
- Equipment-dependent supplements

Keep these documents in the vehicle at all times. If you sell the vehicle, always pass all documents on to the new owner.

### Your Operator's Manual:

#### Digital form inside the vehicle

The Digital Operator's Manual provides comprehensive and specifically adapted information on your vehicle's equipment and multimedia system. It contains informative animations, individual language settings and an intuitive search function.

#### Booklet inside the vehicle

In addition to this manual and the aforementioned digital media, you also have the option to obtain a comprehensive printed version of the Supplement for your multimedia system from your authorized Mercedes-Benz Center.

#### Digital form via the Internet

The Operator's Manual on the Internet provides easy access to all information regarding your vehicle and multimedia system. It also provides helpful animations, interesting background information and a wide array of search options.

#### Digital form as an App

Using the Mercedes-Benz Guides App, you can view all the information on your vehicle and multimedia system via mobile Internet or download it independently of network access. Available for smartphones or tablets.



Apple® iOS



Android™

Please note that the Mercedes-Benz Guides App may not yet be available in your country.  
Mercedes-Benz USA, LLC  
Mercedes-Benz Canada, Inc.  
A Daimler Company

<b>Index</b> .....	<b>4</b>	Mirrors .....	105
<b>Digital Operator's Manual</b> .....	<b>23</b>	Memory function .....	107
Introduction .....	23	<b>Lights and windshield wipers</b> .....	<b>109</b>
Operation .....	23	Exterior lighting .....	109
<b>Introduction</b> .....	<b>24</b>	Interior lighting .....	112
Protecting the environment .....	24	Replacing bulbs .....	113
Genuine Mercedes-Benz parts .....	24	Windshield wipers .....	113
Operator's Manual .....	25	<b>Climate control</b> .....	<b>116</b>
Service and vehicle operation .....	25	Overview of climate control systems ...	116
Operating safety .....	27	Operating the climate control systems .....	118
QR code for rescue card .....	29	Setting the air vents .....	122
Data storage .....	29	<b>Driving and parking</b> .....	<b>125</b>
Information on copyright .....	31	Notes on breaking-in a new vehicle .....	125
<b>At a glance</b> .....	<b>32</b>	Driving .....	125
Cockpit .....	32	DYNAMIC SELECT button (all vehicles except Mercedes-AMG vehicles) .....	132
Instrument cluster .....	33	DYNAMIC SELECT controller (Mercedes-AMG vehicles) .....	133
Multifunction steering wheel .....	34	Automatic transmission .....	134
Center console .....	35	Refueling .....	144
Overhead control panel .....	38	Parking .....	146
Door control panel .....	39	Driving tips .....	149
<b>Safety</b> .....	<b>40</b>	Driving systems .....	154
Panic alarm .....	40	<b>On-board computer and displays</b> ....	<b>190</b>
Occupant safety .....	40	Important safety notes .....	190
Children in the vehicle .....	57	Displays and operation .....	190
Pets in the vehicle .....	59	Menus and submenus .....	193
Driving safety systems .....	60	Display messages .....	205
Protection against theft .....	72	Warning and indicator lamps .....	233
<b>Opening and closing</b> .....	<b>74</b>	<b>Multimedia system</b> .....	<b>243</b>
SmartKey .....	74	General notes .....	243
Doors .....	79	Important safety notes .....	243
Trunk .....	81	Function restrictions .....	243
Side windows .....	87	Operating system .....	244
Roof .....	90	<b>Stowage and features</b> .....	<b>249</b>
<b>Seats, steering wheel and mirrors</b> .....	<b>97</b>	Stowage areas .....	249
Correct driver's seat position .....	97	Features .....	252
Seats .....	97		
Steering wheel .....	103		



---

<b>Maintenance and care</b> .....	<b>265</b>
Engine compartment .....	265
Overview of the engine compart- ment .....	269
ASSYST PLUS .....	269
Care .....	270

---

<b>Breakdown assistance</b> .....	<b>276</b>
Where will I find...? .....	276
Flat tire .....	278
Battery (vehicle) .....	282
Jump-starting .....	285
Towing and tow-starting .....	288
Fuses .....	290

---

<b>Wheels and tires</b> .....	<b>293</b>
Important safety notes .....	293
Operation .....	293
Winter operation .....	295
Tire pressure .....	296
Loading the vehicle .....	303
All about wheels and tires .....	306
Changing a wheel .....	313
Wheel and tire combinations .....	318

---

<b>Technical data</b> .....	<b>319</b>
Information regarding technical data .....	319
Vehicle electronics .....	319
Identification plates .....	320
Service products and filling capaci- ties .....	321
Vehicle data .....	326

## 1, 2, 3 ...

**12 V socket**

see Sockets

**A****ABS (Anti-lock Braking System)**

Display message .....	206
Function/notes .....	60
Important safety notes .....	60
Warning lamp .....	236

**Accident**

Automatic measures after an accident .....	56
---	----

**Activating media mode**

General notes .....	248
---------------------	-----

**Activating/deactivating cooling****with air dehumidification** .....

.....	118
-------	-----

**Active Blind Spot Assist**

Activating/deactivating (on- board computer) .....	199
Display message .....	223
Function/information .....	184

**Active Body Control (ABC)**

CURVE .....	170
Vehicle level .....	168

**Active Body Control (ABC) (except Mercedes-AMG vehicles)**

Comfort .....	169
Driving dynamics display .....	170
Normal level .....	169
Operation/notes .....	168
Raised level .....	169
Sport .....	169
Sport Plus .....	169
Vehicle level .....	168

**Active Body Control (ABC) (Mercedes-AMG vehicles)**

Comfort .....	172
Driving dynamics display .....	172
Normal level .....	171
Operation/notes .....	170
Raised level .....	171
Sport .....	172
Vehicle level .....	170

**Active Body Control (except Mercedes-AMG Vehicles)**

Display message .....	221
-----------------------	-----

**Active Body Control (Mercedes-AMG Vehicles)**

Display message .....	221
-----------------------	-----

**Active Brake Assist**

Activating or deactivating .....	198
Display message .....	211
Function/notes .....	63

**Active Brake Assist with cross-traffic function**

Activating or deactivating .....	198
Display message .....	212
Function/notes .....	70
Important safety notes .....	70
Warning lamp .....	241

**Active Distance Assist****DISTRONIC**

Calling up a speed .....	158
Cruise control lever .....	158
Deactivating .....	161
Display message .....	224
Displays in the multifunction display .....	160
Driving tips .....	162
Function/notes .....	156
Important safety notes .....	156
Indicator and warning lamp .....	241
Setting the specified minimum distance .....	160
Stopping .....	159
Storing a speed .....	158
Warning lamp .....	241

**Active Driving Assistance package** .....

.....	184
-------	-----

**Active Lane Keeping Assist**

Activating/deactivating (on- board computer) .....	199
Display message .....	223
Function/information .....	187

**Active light function** .....

.....	111
-------	-----

**Active Parking Assist**

Canceling .....	179
Detecting parking spaces .....	176
Display message .....	224
Exiting a parking space .....	178
General notes .....	175



- Important safety notes ..... 175
- Parking ..... 177
- Active Steering Assist**
  - Activating/deactivating ..... 198
  - Display message ..... 226
- Adaptive adjustable damping**
  - Driving dynamics display ..... 168
- ADAPTIVE BRAKE** ..... 70
- Adaptive Brake Assist**
  - Function/notes ..... 64
- Adaptive brake lights** ..... 65
- Adaptive Damping System**
  - Function/notes ..... 167
- Adaptive Highbeam Assist**
  - Display message ..... 218
  - Function/notes ..... 111
  - Switching on/off ..... 112
- Additives (engine oil)** ..... 324
- Address book**
  - see also Digital Operator's Manual ..... 243
- Adjusting the volume**
  - Multimedia system ..... 244
- Air bags**
  - Deployment ..... 53
  - Display message ..... 215
  - Front air bag (driver, front passenger) ..... 46
  - Head bag ..... 47
  - Important safety notes ..... 45
  - Introduction ..... 45
  - Knee bag ..... 46
  - Occupant Classification System (OCS) ..... 48
  - PASSENGER AIR BAG indicator lamps ..... 41
  - Side impact air bag ..... 47
- AIR FLOW** ..... 119
- Air vents**
  - Glove box ..... 123
  - Important safety notes ..... 122
  - Setting ..... 122
  - Setting the blower output of the AIRSCARF vents ..... 124
  - Setting the center air vents ..... 123
  - Setting the side air vents ..... 123
  - Switching AIRSCARF on/off ..... 102
- Air-conditioning system**
  - see Climate control
- AIRSCARF**
  - Switching on/off ..... 102
- AIRSCARF vents**
  - Setting the blower output ..... 124
- Alarm**
  - ATA (Anti-Theft Alarm system) ..... 72
  - Switching off (ATA) ..... 72
  - Switching the function on/off (ATA) ..... 72
- Alarm system**
  - see ATA (Anti-Theft Alarm system)
- Ambient lighting**
  - Setting the brightness (on-board computer) ..... 200
  - Setting the color (on-board computer) ..... 200
- AMG menu (on-board computer)** ..... 202
- Anti-lock braking system**
  - see ABS (Anti-lock Braking System)
- Anti-skid chains**
  - see Snow chains
- Anti-theft alarm system**
  - see ATA (Anti-Theft Alarm system)
- Ashtray** ..... 254
- Assistance display (on-board computer)** ..... 198
- Assistance menu (on-board computer)** ..... 197
- ASSYST PLUS**
  - Displaying a service message ..... 270
  - Hiding a service message ..... 270
  - Resetting the service interval display ..... 270
  - Service message ..... 269
  - Special service requirements ..... 270
- ATA (Anti-Theft Alarm system)**
  - Activating/deactivating ..... 72
  - Function ..... 72
  - Switching off the alarm ..... 72
- ATTENTION ASSIST**
  - Activating/deactivating ..... 198
  - Display message ..... 222
  - Function/notes ..... 183
- Audio menu (on-board computer)** ..... 195

- Audio system**  
see Digital Operator's Manual
- Authorized Mercedes-Benz Center**  
see Qualified specialist workshop
- Authorized workshop**  
see Qualified specialist workshop
- AUTO lights**  
Display message ..... 217  
see Lights
- Automatic car wash (care)** ..... 271
- Automatic engine start (ECO start/stop function)** ..... 130
- Automatic engine switch-off (ECO start/stop function)** ..... 129
- Automatic headlamp mode** ..... 109
- Automatic transmission**  
Accelerator pedal position ..... 138  
Changing gear ..... 138  
Display message ..... 228  
Drive program ..... 138  
Drive program display ..... 135  
Driving tips ..... 138  
DYNAMIC SELECT button (all vehicles except Mercedes-AMG vehicles) ..... 132  
DYNAMIC SELECT controller (Mercedes-AMG vehicles) ..... 133  
Emergency running mode ..... 144  
Engaging drive position ..... 137  
Engaging neutral ..... 136  
Engaging park position automatically ..... 136  
Engaging reverse gear ..... 136  
Engaging the park position ..... 136  
Gearshift recommendation ..... 143  
Kickdown ..... 138  
Manual shifting ..... 141  
Oil temperature (on-board computer, Mercedes-AMG vehicles) ..... 202  
Overview ..... 134  
Problem (malfunction) ..... 144  
Pulling away ..... 128  
Selector lever ..... 134  
Starting the engine ..... 128  
Steering wheel paddle shifters ..... 141  
Transmission position display ..... 135  
Transmission positions ..... 137
- Automatic transmission emergency mode** ..... 144
- B**
- Back button** ..... 244
- BAS (Brake Assist System)** ..... 61
- Battery (SmartKey)**  
Checking ..... 77  
Important safety notes ..... 76  
Replacing ..... 77
- Battery (vehicle)**  
Charging ..... 284  
Display message ..... 219  
Important safety notes ..... 282  
Jump starting ..... 285  
Overview ..... 282  
Replacing ..... 285
- Belt**  
see Seat belts
- Belt warning** ..... 44
- Blind Spot Assist**  
see Active Blind Spot Assist
- Bluetooth®**  
Searching for a mobile phone ..... 247  
see also Digital Operator's Manual ..... 243  
Telephony ..... 246
- Brake Assist System**  
see BAS (Brake Assist System)
- Brake Assist with cross-traffic function**  
Function/notes ..... 61  
Important safety notes ..... 61
- Brake fluid**  
Display message ..... 211  
Notes ..... 324
- Brake force distribution**  
see EBD (electronic brake force distribution)
- Brake lamps**  
Adaptive ..... 65  
Display message ..... 217
- Brakes**  
ABS ..... 60  
Adaptive Brake Assist ..... 64  
BAS ..... 61



- Brake Assist with cross-traffic function ..... 61
  - Brake fluid (notes) ..... 324
  - Display message ..... 206
  - EBD ..... 69
  - High-performance brake system .... 152
  - Important safety notes ..... 151
  - Maintenance ..... 152
  - Parking brake ..... 147
  - Riding tips ..... 151
  - Warning lamp ..... 235
  - Breakdown assistance**
    - Reflective safety jacket ..... 276
    - Where will I find...? ..... 276
    - see Flat tire
    - see Towing away
  - Brightness control (instrument cluster lighting)** ..... 33
- C**
- California**
    - Important notice for retail customers and lessees ..... 25
  - Calling up a malfunction**
    - see Display messages
  - Car**
    - see Vehicle
  - Care**
    - Car wash ..... 271
    - Exhaust pipe ..... 275
    - Exterior lights ..... 275
    - Matte finish ..... 273
    - Notes ..... 270
    - Paint ..... 272
    - Power washer ..... 272
    - Rear view camera ..... 275
    - Sensors ..... 275
    - Washing by hand ..... 271
    - Wheels ..... 274
    - Windows ..... 274
    - Wiper blades ..... 274
  - CD**
    - see also Digital Operator's Manual ..... 243
  - CD player (on-board computer)** ..... 196
  - Center console**
    - Lower section ..... 36
    - Lower section (AMG vehicles) ..... 37
    - Upper section ..... 35
  - Central locking**
    - Automatic locking (on-board computer) ..... 201
    - Locking/unlocking (SmartKey) ..... 74
  - Child**
    - Restraint system ..... 58
  - Child seat**
    - Forward-facing restraint system ..... 59
    - On the front-passenger seat ..... 59
    - Rearward-facing restraint system .... 59
  - Children**
    - Special seat belt retractor ..... 57
  - Children in the vehicle**
    - Important safety notes ..... 57
  - Cigarette lighter** ..... 254
  - Cleaning**
    - Mirror turn signal ..... 275
  - Climate control**
    - Automatic climate control (dual-zone) ..... 116
    - Controlling automatically ..... 119
    - Cooling with air dehumidification .. 118
    - Defrosting the windows ..... 121
    - Defrosting the windshield ..... 120
    - General notes ..... 116
    - Indicator lamp ..... 119
    - Information about using automatic climate control ..... 117
    - Maximum cooling ..... 121
    - Overview of systems ..... 116
    - Problem with the rear window defroster ..... 121
    - Problems with cooling with air dehumidification ..... 119
    - Refrigerant ..... 326
    - Refrigerant filling capacity ..... 326
    - Setting the air distribution ..... 120
    - Setting the air vents ..... 122
    - Setting the airflow ..... 120
    - Setting the climate mode (AIR FLOW) ..... 119
    - Setting the temperature ..... 119
    - Switching air-recirculation mode on/off ..... 122
    - Switching on/off ..... 118
    - Switching residual heat on/off ..... 122

- Switching the rear window defroster on/off ..... 121
  - Switching the ZONE function on/off ..... 120
  - Cockpit**
    - Overview ..... 32
    - see Instrument cluster
  - COMAND**
    - Driving dynamics display (except Mercedes-AMG vehicles) ..... 168, 170
    - Driving dynamics display (Mercedes-AMG vehicles) ..... 172
  - Combination switch** ..... 110
  - Compass**
    - Calibrating ..... 263
    - Calling up ..... 262
    - Setting ..... 263
  - Connecting a USB device**
    - see also Digital Operator's Manual ..... 243
  - Consumption statistics (on-board computer)** ..... 193
  - Controller** ..... 244
  - Convenience closing feature** ..... 89
  - Coolant (engine)**
    - Checking the level ..... 267
    - Display message ..... 218
    - Filling capacity ..... 325
    - Important safety notes ..... 324
    - Temperature (on-board computer, Mercedes-AMG vehicles) ..... 202
    - Temperature gauge ..... 191
    - Warning lamp ..... 239
  - Cooling**
    - see Climate control
  - Copyright** ..... 31
  - Cornering light function**
    - Display message ..... 217
    - Function/notes ..... 111
  - Cruise control**
    - Cruise control lever ..... 154
    - Deactivating ..... 155
    - Display message ..... 226
    - Driving system ..... 154
    - Function/notes ..... 154
    - Important safety notes ..... 154
    - Setting a speed ..... 155
  - Storing and maintaining current speed ..... 154
  - Cup holder**
    - Center console ..... 253
    - Important safety notes ..... 252
  - Customer Assistance Center (CAC)** ..... 29
  - Customer Relations Department** ..... 29
- D**
- Data**
    - see Technical data
  - Data carrier**
    - Selecting ..... 196
  - Daytime running lamps**
    - Display message ..... 217
    - Function/notes ..... 109
    - Switching on/off (on-board computer) ..... 200
  - Declarations of conformity** ..... 27
  - Decorative film**
    - Cleaning instructions ..... 273
  - Delayed switch-off**
    - Exterior lighting (on-board computer) ..... 200
    - Interior lighting ..... 201
  - Diagnostics connection** ..... 28
  - Digital Operator's Manual**
    - Help ..... 23
    - Introduction ..... 23
  - Digital speedometer** ..... 194
  - Display messages**
    - ASSYST PLUS ..... 269
    - Calling up (on-board computer) ..... 205
    - Driving systems ..... 221
    - Engine ..... 218
    - General notes ..... 205
    - Hiding (on-board computer) ..... 205
    - KEYLESS-GO ..... 232
    - Lights ..... 217
    - Safety systems ..... 206
    - SmartKey ..... 231
    - Tires ..... 227
    - Vehicle ..... 228
  - Distance recorder**
    - see Odometer
    - see Trip odometer



- Distance warning (warning lamp) ....** 241
- Distance warning function**
  - Function/notes ..... 63
- Doors**
  - Automatic locking (on-board computer) ..... 201
  - Automatic locking (switch) ..... 81
  - Central locking/unlocking (SmartKey) ..... 74
  - Control panel ..... 39
  - Display message ..... 230
  - Emergency locking ..... 81
  - Emergency unlocking ..... 81
  - Important safety notes ..... 79
  - Opening (from inside) ..... 80
  - Overview ..... 79
  - Power closing ..... 81
- Drinking and driving** ..... 149
- Drive program**
  - Automatic transmission ..... 138
  - Display ..... 135
  - SETUP (on-board computer, Mercedes-AMG vehicles) ..... 203
- Driver's door**
  - see Doors
- Driving**
  - Towing vehicles ..... 132
- Driving abroad**
  - Mercedes-Benz Service ..... 270
- Driving on flooded roads** ..... 153
- Driving safety system**
  - Active Brake Assist ..... 63
- Driving safety systems**
  - ABS (Anti-lock Braking System) ..... 60
  - Active Brake Assist with cross-traffic function ..... 70
  - ADAPTIVE BRAKE ..... 70
  - Adaptive Brake Assist ..... 64
  - Adaptive brake lights ..... 65
  - BAS (Brake Assist System) ..... 61
  - Brake Assist with cross-traffic function ..... 61
  - Distance warning function ..... 63
  - EBD (electronic brake force distribution) ..... 69
  - ESP® (Electronic Stability Program) ..... 65
  - Important safety information ..... 60
  - Overview ..... 60
  - STEER CONTROL ..... 72
- Driving system**
  - Active Body Control (ABC) (except Mercedes-AMG vehicles) .. 168
  - Active Body Control (ABC) (Mercedes-AMG vehicles) ..... 170
  - RACE START (Mercedes-AMG vehicles) ..... 166
- Driving systems**
  - Active Blind Spot Assist ..... 184
  - Active Driving Assistance package ..... 184
  - Active Lane Keeping Assist ..... 187
  - Active Parking Assist ..... 175
  - Adaptive Damping System ..... 167
  - ATTENTION ASSIST ..... 183
  - Cruise control ..... 154
  - Display message ..... 221
  - DISTRONIC PLUS ..... 156, 163
  - HOLD function ..... 165
  - PARKTRONIC ..... 172
  - Rear view camera ..... 179
- Driving tips**
  - Active Distance Assist
  - DISTRONIC ..... 162
  - AMG ceramic brakes ..... 152
  - Automatic transmission ..... 138
  - Brakes ..... 151
  - Break-in period ..... 125
  - Downhill gradient ..... 151
  - Drinking and driving ..... 149
  - Driving in winter ..... 153
  - Driving on flooded roads ..... 153
  - Driving on wet roads ..... 153
  - Exhaust check ..... 150
  - Fuel ..... 149
  - General ..... 149
  - Hydroplaning ..... 153
  - Icy road surfaces ..... 153
  - Limited braking efficiency on salted roads ..... 152
  - Snow chains ..... 295
  - Subjecting brakes to a load ..... 151
  - Wet road surface ..... 151
- DVD video**
  - Operating (on-board computer) ..... 196

- see also Digital Operator's Manual ..... 243
- DYNAMIC SELECT button (all vehicles except Mercedes-AMG vehicles)** ..... 132
- DYNAMIC SELECT controller (Mercedes-AMG vehicles)** ..... 133
- E**
- EASY-ENTRY feature**
- Activating/deactivating ..... 201
  - Function/notes ..... 103
- EASY-EXIT feature**
- Crash-responsive ..... 104
  - Function/notes ..... 103
  - Switching on/off ..... 201
- EBD (electronic brake force distribution)**
- Display message ..... 208
  - Function/notes ..... 69
- ECO display**
- Function/notes ..... 150
  - On-board computer ..... 193
- ECO start/stop function**
- Automatic engine start ..... 130
  - Automatic engine switch-off ..... 129
  - Deactivating/activating ..... 130
  - General information ..... 129
  - Important safety notes ..... 129
  - Introduction ..... 129
- Electronic Stability Program**
- see ESP® (Electronic Stability Program)
- Emergency**
- Automatic measures after an accident ..... 56
- Emergency release**
- Driver's door ..... 81
  - Trunk ..... 86
  - Vehicle ..... 81
- Emergency Tensioning Devices**
- Activation ..... 53
- Emissions control**
- Service and warranty information .... 25
- Engine**
- Check Engine warning lamp ..... 239
  - Display message ..... 218
  - ECO start/stop function ..... 129
  - Engine number ..... 321
  - Irregular running ..... 131
  - Jump-starting ..... 285
  - Overview ..... 269
  - Starting problems ..... 131
  - Starting the engine with the SmartKey ..... 128
  - Starting with KEYLESS-GO ..... 128
  - Switching off ..... 147
  - Tow-starting (vehicle) ..... 290
- Engine electronics**
- Notes ..... 319
  - Problem (malfunction) ..... 131
- Engine oil**
- Adding ..... 266
  - Additives ..... 324
  - Checking the oil level ..... 266
  - Checking the oil level using the dipstick ..... 266
  - Display message ..... 220
  - Filling capacity ..... 324
  - General notes ..... 323
  - Notes about oil grades ..... 323
  - Notes on oil level/consumption .... 266
  - Temperature (on-board computer, Mercedes-AMG vehicles) .... 202
- Entering an address**
- see also Digital Operator's Manual ..... 243
- ESP® (Electronic Stability Program)**
- AMG menu (on-board computer) ... 203
  - Characteristics ..... 66
  - Deactivating/activating (button in Mercedes-AMG vehicles) ..... 68
  - Deactivating/activating (except Mercedes-AMG vehicles) ..... 67
  - Display message ..... 206
  - Function/notes ..... 65
  - General notes ..... 65
  - Important safety information ..... 66
  - Warning lamp ..... 236
- ETS/4ETS (Electronic Traction System)** ..... 66
- Exhaust check** ..... 150
- Exhaust pipe (cleaning instructions)** ..... 275

- Exterior lighting**  
 Setting options ..... 109  
 see Lights
- Exterior mirrors**  
 Adjusting ..... 105  
 Dipping (automatic) ..... 106  
 Folding in when locking (on-board computer) ..... 202  
 Folding in/out (electrically) ..... 105  
 Out of position (troubleshooting) ... 105  
 Storing settings (memory function) ..... 107  
 Storing the parking position ..... 106
- Eyeglasses compartment** ..... 250
- F**
- Favorites**  
 Overview ..... 245
- Filler cap**  
 see Refueling
- Filling capacities (Technical data)** ... 321
- First-aid kit** ..... 276
- Flat tire**  
 MOExtended tires ..... 278  
 Preparing the vehicle ..... 278  
 TIREFIT kit ..... 279
- Floormats** ..... 263
- Frequencies**  
 Mobile phone ..... 319  
 Two-way radio ..... 319
- Front-passenger seat**  
 Adjusting from the driver's seat ..... 99
- Fuel**  
 Additives ..... 323  
 Consumption statistics ..... 193  
 Displaying the current consumption ..... 193  
 Displaying the range ..... 193  
 Driving tips ..... 149  
 Fuel gauge ..... 33  
 Grade (gasoline) ..... 322  
 Important safety notes ..... 322  
 Problem (malfunction) ..... 146  
 Refueling ..... 144  
 Tank content/reserve fuel ..... 322
- Fuel filler flap**  
 Opening ..... 145
- Fuel level**  
 Calling up the range (on-board computer) ..... 193
- Fuel tank**  
 Capacity ..... 322  
 Problem (malfunction) ..... 146
- Fuse allocation chart (vehicle tool kit)** ..... 277
- Fuses**  
 Allocation chart ..... 290  
 Before changing ..... 291  
 Dashboard fuse box ..... 291  
 Fuse box in the engine compartment ..... 291  
 Fuse box in the rear compartment ..... 292  
 Important safety notes ..... 290
- G**
- Garage door opener**  
 Clearing the memory ..... 262  
 General notes ..... 259  
 Important safety notes ..... 260  
 Opening/closing the garage door .. 262  
 Problems when programming ..... 261  
 Programming (button in the rear-view mirror) ..... 260  
 Synchronizing the rolling code ..... 261
- Gear indicator (on-board computer, Mercedes-AMG vehicles)** ..... 202
- Genuine parts** ..... 24
- Glove box** ..... 249
- Google™ Local Search**  
 see also Digital Operator's Manual ..... 243
- H**
- HANDS-FREE ACCESS** ..... 84
- Hazard warning lamps**  
 Display message ..... 231  
 Switching on/off ..... 111
- Head bags**  
 Display message ..... 214  
 Operation ..... 47
- Head level heating (AIRSCARF)** ..... 102

- Head restraints**  
 Adjusting ..... 100  
 see NECK-PRO head restraints
- Headlamps**  
 see Automatic headlamp mode
- Heating**  
 see Climate control
- High beam flasher** ..... 110
- High-beam headlamps**  
 Display message ..... 217  
 Switching on/off ..... 110
- Hill start assist** ..... 129
- HOLD function**  
 Activating ..... 165  
 Activation conditions ..... 165  
 Deactivating ..... 165  
 Display message ..... 222  
 General notes ..... 165
- Home address**  
 see also Digital Operator's Manual ..... 243
- Hood**  
 Closing ..... 266  
 Display message ..... 230  
 Important safety notes ..... 265  
 Opening ..... 265
- Horn** ..... 32
- Hydroplaning** ..... 153
- I**
- Ignition lock**  
 see Key positions
- Immobilizer** ..... 72
- Indicator lamps**  
 see Warning and indicator lamps
- Indicators**  
 see Turn signals
- Instrument cluster**  
 Overview ..... 33
- Instrument cluster lighting** ..... 190
- Interior lighting**  
 Automatic control ..... 113  
 Delayed switch-off (on-board computer) ..... 201  
 Reading lamp ..... 112
- Setting the brightness of the ambient lighting (on-board computer) ..... 200
- iPod®**  
 see also Digital Operator's Manual ..... 243
- J**
- Jack**  
 Storage location ..... 278  
 Using ..... 314
- Jump starting (engine)** ..... 285
- K**
- Key positions**  
 KEYLESS-GO ..... 126  
 SmartKey ..... 126
- KEYLESS-GO**  
 Activating ..... 74  
 Convenience closing feature ..... 89  
 Deactivation ..... 74  
 Display message ..... 232  
 Locking ..... 74  
 Removing the Start/Stop button ... 127  
 Start/Stop button ..... 126  
 Starting the engine ..... 128  
 Unlocking ..... 74
- Kickdown**  
 Driving tips ..... 138  
 Manual gearshifting ..... 143
- Knee bag** ..... 46
- L**
- Lamps**  
 see Warning and indicator lamps
- Lane Keeping Assist**  
 see Active Lane Keeping Assist
- Lap time (RACETIMER)** ..... 203
- License plate lamp (display message)** ..... 217
- Light function, active**  
 Display message ..... 217
- Light sensor (display message)** ..... 217
- Lights**  
 Activating/deactivating the interior lighting delayed switch-off ..... 201

- Active light function ..... 111
  - Automatic headlamp mode ..... 109
  - Cornering light function ..... 111
  - Hazard warning lamps ..... 111
  - High beam flasher ..... 110
  - High-beam headlamps ..... 110
  - Light switch ..... 109
  - Low-beam headlamps ..... 110
  - Parking lamps ..... 110
  - Setting the brightness of the ambient lighting (on-board computer) ..... 200
  - Standing lamps ..... 110
  - Switching the daytime running lamps on/off (on-board computer) ..... 200
  - Switching the exterior lighting delayed switch-off on/off (on-board computer) ..... 200
  - Switching the surround lighting on/off (on-board computer) ..... 200
  - Turn signals ..... 110
  - see Interior lighting
  - see Replacing the bulbs
  - Loading aid (trunk)**
    - Raising/lowering the roof ..... 251
  - Locking**
    - see Central locking
  - Locking (doors)**
    - Automatic ..... 81
    - Emergency locking ..... 81
    - From inside (central locking button) ..... 80
  - Locking centrally**
    - see Central locking
  - Locking verification signal (on-board computer)** ..... 201
  - Low-beam headlamps**
    - Display message ..... 217
    - Switching on/off ..... 110
  - Luggage cover**
    - see Trunk partition
- M**
- M+S tires** ..... 295
  - MAGIC SKY CONTROL** ..... 94
  - Malfunction message**
    - see Display messages
  - Matte finish (cleaning instructions)** ..... 273
  - Mechanical key**
    - Function/notes ..... 76
    - General notes ..... 76
    - Inserting ..... 76
    - Locking vehicle ..... 81
    - Removing ..... 76
    - Unlocking the driver's door ..... 81
  - Media Interface**
    - see Digital Operator's Manual
  - Memory card (audio)** ..... 196
  - Memory function** ..... 107
  - Mercedes me connect**
    - Call priority ..... 258
    - General notes ..... 255
    - Info call button ..... 258
    - Mercedes-Benz emergency call ..... 256
    - Remote Vehicle Health Check ..... 259
    - Roadside Assistance call button ..... 257
    - Self-diagnosis ..... 255
    - System ..... 255
  - Mercedes-Benz Intelligent Drive**
    - Active Blind Spot Assist ..... 184
    - Active Distance Assist
    - DISTRONIC with Active Steering Assist ..... 163
    - Active Lane Keeping Assist ..... 187
    - ATTENTION ASSIST ..... 183
    - PRE-SAFE® PLUS (anticipatory occupant protection PLUS) ..... 56
    - Rear view camera ..... 179
  - Message memory (on-board computer)** ..... 205
  - Messages**
    - see Display messages
  - Mirrors**
    - see Exterior mirrors
  - Mobile phone**
    - Connecting (Bluetooth® interface) ..... 246
    - Frequencies ..... 319
    - Installation ..... 319
    - Menu (on-board computer) ..... 196
    - Transmission output (maximum) ..... 319



<b>Modifying the programming (SmartKey)</b> .....	75
<b>MOExtended tires</b> .....	278
<b>Mounting wheels</b>	
Lowering the vehicle .....	317
Mounting a new wheel .....	316
Preparing the vehicle .....	313
Raising the vehicle .....	314
Removing a wheel .....	316
Securing the vehicle against rolling away .....	314
<b>MP3</b>	
Operation .....	196
see also Digital Operator's Manual .....	243
<b>Multifunction display</b>	
Function/notes .....	192
Permanent display .....	199
<b>Multifunction steering wheel</b>	
Operating the on-board computer .....	191
Overview .....	34
<b>Multimedia system</b>	
Switching on and off .....	244
<b>Music files</b>	
see also Digital Operator's Manual .....	243

## N

<b>Navigation</b>	
Entering a destination .....	245
Menu (on-board computer) .....	194
see also Digital Operator's Manual .....	243
<b>Navigation menu</b>	
Important safety notes .....	194
<b>NECK-PRO head restraints</b>	
Important safety notes .....	55
Operation .....	55
Resetting triggered .....	55
<b>Notes on breaking-in a new vehicle</b> .....	125

## O

<b>Occupant Classification System (OCS)</b>	
Conditions .....	48
Faults .....	51
Operation .....	48
Self-test .....	50
<b>Occupant safety</b>	
Air bags .....	45
Automatic measures after an accident .....	56
Belt warning .....	44
Children in the vehicle .....	57
Important safety notes .....	40
Introduction to the restraint system .....	40
Occupant Classification System (OCS) .....	48
PASSENGER AIR BAG indicator lamps .....	41
Pets in the vehicle .....	59
PRE-SAFE® (anticipatory occupant protection) .....	55
PRE-SAFE® PLUS (anticipatory occupant protection PLUS) .....	56
Restraint system warning lamp .....	41
Seat belt .....	41
<b>OCS</b>	
Faults .....	51
Operation .....	48
Self-test .....	50
<b>Odometer</b> .....	193
<b>Oil</b>	
see Engine oil	
<b>On-board computer</b>	
AMG menu .....	202
Assistance menu .....	197
Audio menu .....	195
Convenience submenu .....	201
Display messages .....	205
Displaying a service message .....	270
Factory settings submenu .....	202
Important safety notes .....	190
Instrument cluster submenu .....	199
Lighting submenu .....	200
Menu overview .....	193
Message memory .....	205

- Navigation menu ..... 194
  - Operation ..... 191
  - RACETIMER ..... 203
  - Service menu ..... 199
  - Settings menu ..... 199
  - Standard display ..... 193
  - Telephone menu ..... 196
  - Trip menu ..... 193
  - Vehicle submenu ..... 201
  - Video DVD operation ..... 196
  - Operating safety**
    - Declaration of conformity ..... 27
    - Important safety notes ..... 27
  - Operating system**
    - see On-board computer
  - Operation**
    - Digital Operator's Manual ..... 23
  - Operator's Manual**
    - Vehicle equipment ..... 25
  - Outside temperature display** ..... 190
  - Overhead control panel** ..... 38
- P**
- Paddle shifters**
    - see Steering wheel paddle shifters
  - Paint code number** ..... 320
  - Paintwork (cleaning instructions)** ... 272
  - Panic alarm** ..... 40
  - Panoramic roof**
    - Operating the roller sunblind ..... 94
  - Parking**
    - Important safety notes ..... 146
    - Parking brake ..... 147
    - Position of exterior mirror, front-passenger side ..... 106
    - Rear view camera ..... 179
    - see PARKTRONIC
  - Parking aid**
    - see Active Parking Assist
    - see Exterior mirrors
    - see PARKTRONIC
  - Parking Assist PARKTRONIC**
    - Deactivating/activating ..... 174
    - Important safety notes ..... 172
    - Problems (malfunctions) ..... 175
    - Sensor range ..... 173
    - Warning display ..... 174
  - Parking brake**
    - Applying automatically ..... 148
    - Applying or releasing manually ..... 148
    - Display message ..... 208
    - Electric parking brake ..... 147
    - Emergency braking ..... 148
    - General notes ..... 147
    - Releasing automatically ..... 148
    - Warning lamp ..... 238
  - Parking lamps**
    - Switching on/off ..... 110
  - PARKTRONIC**
    - Driving system ..... 172
    - Function/notes ..... 172
  - PASSENGER AIR BAG**
    - Display message ..... 215
    - Indicator lamps ..... 41
    - Problems (malfunction) ..... 215
  - Pets in the vehicle** ..... 59
  - Phone book**
    - see also Digital Operator's Manual ..... 243
  - Power locks** ..... 81
  - Power washers** ..... 272
  - Power windows**
    - see Side windows
  - PRE-SAFE® (anticipatory occupant protection)**
    - Display message ..... 211
    - Operation ..... 55
  - PRE-SAFE® PLUS (anticipatory occupant protection PLUS)**
    - Operation ..... 56
  - Protection against theft**
    - ATA (Anti-Theft Alarm system) ..... 72
    - Immobilizer ..... 72
  - Protection of the environment**
    - General notes ..... 24
  - Pulling away**
    - General notes ..... 128
  - Pulling away (automatic transmission)** ..... 128
- Q**
- QR code**
    - Mercedes-Benz Guide App ..... 1
    - Rescue card ..... 29

- Qualified specialist workshop** ..... 28
- R**
- RACE START**
- Important safety notes ..... 166
- RACE START (Mercedes-AMG vehicles)** ..... 166
- RACE TIMER (on-board computer, Mercedes-AMG vehicles)** ..... 203
- Radio**
- Selecting a station ..... 195
- see Digital Operator's Manual
- Radio mode**
- see also Digital Operator's Manual ..... 243
- Radio-wave reception/transmission in the vehicle**
- Declaration of conformity ..... 27
- REACH Regulation** ..... 28
- Reading lamp** ..... 112
- Rear fog lamp**
- Display message ..... 217
- Rear lamps**
- see Lights
- Rear view camera**
- Cleaning instructions ..... 275
- Display in the multimedia system .. 180
- Function/notes ..... 179
- Switching on/off ..... 180
- Rear window defroster**
- General notes ..... 121
- Problem (malfunction) ..... 121
- Switching on/off ..... 121
- Rear-view mirror**
- Dipping (automatic) ..... 106
- Refrigerant (air-conditioning system)**
- Important safety notes ..... 326
- Refueling**
- Fuel gauge ..... 33
- Important safety notes ..... 144
- Refueling process ..... 145
- see Fuel
- Remote control**
- Programming (garage door opener) ..... 260
- Replacing bulbs**
- General notes ..... 113
- Reporting safety defects** ..... 29
- Rescue card** ..... 29
- Reserve (fuel tank)**
- see Fuel
- Reserve fuel**
- Display message ..... 221
- Warning lamp ..... 239
- Residual heat (climate control)** ..... 122
- Restraint system**
- Display message ..... 214
- Introduction ..... 40
- Warning lamp ..... 238
- Warning lamp (function) ..... 41
- Reverse gear (selector lever)** ..... 136
- Reversing feature**
- Side windows ..... 87
- Trunk lid ..... 82
- Reversing lamps (display message)** ..... 217
- Roadside Assistance (breakdown)** .... 26
- Roll bar**
- Display message ..... 213
- Operation ..... 52
- Roller sunblind** ..... 94
- Roof**
- Display message ..... 230
- Important safety notes ..... 90
- Opening/closing (with roof switch) ..... 91
- Opening/closing (with SmartKey) .... 92
- Overview ..... 90
- Problem (malfunction) ..... 95
- Relocking ..... 92
- Roof switch** ..... 91
- Route guidance**
- see also Digital Operator's Manual ..... 243
- Route guidance active** ..... 194
- S**
- Safety**
- Children in the vehicle ..... 57
- see Occupant safety
- Safety system**
- see Driving safety systems

- SD card**
  - Inserting ..... 248
  - Inserting/removing ..... 248
  - Removing ..... 248
- SD memory card**
  - see also Digital Operator's Manual ..... 243
  - Selecting ..... 196
- Search & Send**
  - see also Digital Operator's Manual ..... 243
- Seat**
  - Correct driver's seat position ..... 97
- Seat belts**
  - Adjusting the driver's and front-passenger seat belt ..... 44
  - Correct usage ..... 43
  - Fastening ..... 44
  - Important safety guidelines ..... 42
  - Introduction ..... 41
  - Releasing ..... 44
  - Seat belt guide ..... 99
  - Switching belt adjustment on/off (on-board computer) ..... 202
  - Warning lamp ..... 233
  - Warning lamp (function) ..... 44
- Seats**
  - Adjusting (electrically) ..... 99
  - Adjusting the head restraint ..... 100
  - Belt guide ..... 99
  - Important safety notes ..... 97
  - Overview ..... 97
  - Seat heating problem ..... 101
  - Seat ventilation problem ..... 102
  - Sliding forward/back ..... 100
  - Storing settings (memory function) ..... 107
  - Switching AIRSCARF on/off ..... 102
  - Switching seat heating on/off ..... 101
  - Switching seat ventilation on/off .. 102
- Selector lever**
  - Positions ..... 134
- Sensors (cleaning instructions) ..... 275**
- Service menu (on-board computer) ..... 199**
- Service message**
  - see ASSYST PLUS
- Service products**
  - Brake fluid ..... 324
  - Coolant (engine) ..... 324
  - Engine oil ..... 323
  - Fuel ..... 322
  - Important safety notes ..... 321
  - Refrigerant (air-conditioning system) ..... 326
  - Washer fluid ..... 325
- Setting the air distribution ..... 120**
- Setting the airflow ..... 120**
- Setting the date/time format**
  - see also Digital Operator's Manual ..... 243
- Setting the language**
  - see also Digital Operator's Manual ..... 243
- Setting the time**
  - see also Digital Operator's Manual ..... 243
- Settings**
  - Factory (on-board computer) ..... 202
  - On-board computer ..... 199
- SETUP (on-board computer, Mercedes-AMG vehicles) ..... 203**
- Side impact air bag ..... 47**
- Side marker lamp (display message) ..... 217**
- Side windows**
  - Cleaning ..... 274
  - Convenience closing feature ..... 89
  - Important safety information ..... 87
  - Opening/closing (all) ..... 88
  - Opening/closing (front) ..... 88
  - Opening/closing (rear) ..... 88
  - Overview ..... 87
  - Problem (malfunction) ..... 90
  - Resetting ..... 89
  - Reversing feature ..... 87
- SIRIUS services**
  - see also Digital Operator's Manual ..... 243
- SmartKey**
  - Changing the battery ..... 77
  - Changing the programming ..... 75
  - Checking the battery ..... 77
  - Display message ..... 231

- Door central locking/unlocking ..... 74
  - Important safety notes ..... 74
  - Loss ..... 78
  - Mechanical key ..... 76
  - Opening/closing the roof ..... 92
  - Overview ..... 74
  - Positions (ignition lock) ..... 126
  - Problem (malfunction) ..... 78
  - Starting the engine ..... 128
  - SMS**
    - see also Digital Operator's Manual ..... 243
  - Snow chains** ..... 295
  - Sockets**
    - Front-passenger footwell ..... 255
    - General notes ..... 254
    - Trunk ..... 255
  - Sound**
    - Switching on/off ..... 244
  - Special seat belt retractor** ..... 57
  - Specialist workshop** ..... 28
  - Speed, controlling**
    - see Cruise control
  - Speedometer**
    - Digital ..... 194
    - In the Instrument cluster ..... 33
    - Segments ..... 190
    - Selecting the display unit ..... 199
  - SPORT handling mode**
    - Deactivating/activating (Mercedes-AMG vehicles) ..... 68
    - Warning lamp ..... 238
  - Standing lamps**
    - Display message ..... 217
    - Switching on/off ..... 110
  - Start/stop function**
    - see ECO start/stop function
  - Starting (engine)** ..... 127
  - STEER CONTROL** ..... 72
  - Steering**
    - Display message ..... 230
  - Steering assistant STEER CONTROL**
    - see STEER CONTROL
  - Steering wheel**
    - Adjusting (electrically) ..... 103
    - Button overview ..... 34
  - Buttons (on-board computer) ..... 191
  - Important safety notes ..... 103
  - Storing settings (memory function) ..... 107
  - Steering wheel paddle shifters** ..... 141
  - Stopwatch (RACETIMER)** ..... 203
  - Stowage areas** ..... 249
  - Stowage compartments**
    - Armrest (under) ..... 249
    - Center console ..... 250
    - Center console (rear) ..... 250
    - Cup holders ..... 252
    - Eyeglasses compartment ..... 250
    - Glove box ..... 249
    - Important safety information ..... 249
    - Rear ..... 251
    - Stowage net ..... 251
  - Stowage net** ..... 251
  - Stowage space**
    - Umbrella holder ..... 250
  - Stowage well beneath the trunk floor** ..... 252
  - Summer tires** ..... 295
  - Sun visor** ..... 253
  - Surround lighting (on-board computer)** ..... 200
  - Suspension settings**
    - Active Body Control (ABC) (except Mercedes-AMG vehicles) .. 169
    - Active Body Control (ABC) (Mercedes-AMG vehicles) ..... 171
  - Suspension tuning**
    - SETUP (on-board computer, Mercedes-AMG vehicles) ..... 203
  - SVHC (Substances of Very High Concern)** ..... 28
  - Switching air-recirculation mode on/off** ..... 122
  - Switching on media mode**
    - Via the device list ..... 248
- T**
- Tachometer** ..... 190
  - Tail lamps**
    - Display message ..... 217
    - see Lights



- Tank content**  
 Fuel gauge ..... 33
- Technical data**  
 Capacities ..... 321  
 Information ..... 319  
 Tires/wheels ..... 318  
 Vehicle data ..... 326
- TELEAID**  
 Call priority ..... 258  
 Emergency call ..... 256  
 General notes ..... 255  
 MB info call button ..... 258  
 Roadside Assistance button ..... 257  
 Self-test ..... 255  
 System ..... 255  
 Vehicle Health Check ..... 259
- Telephone**  
 Accepting a call (multifunction steering wheel) ..... 197  
 Authorizing a mobile phone (connecting) ..... 247  
 Connecting a mobile phone (general information) ..... 246  
 Display message ..... 230  
 Menu (on-board computer) ..... 196  
 Number from the phone book ..... 197  
 Redialing ..... 197  
 Rejecting/ending a call ..... 197  
 see also Digital Operator's Manual ..... 243
- Temperature**  
 Coolant ..... 191  
 Coolant (on-board computer, Mercedes-AMG vehicles) ..... 202  
 Engine oil (on-board computer, Mercedes-AMG vehicles) ..... 202  
 Outside temperature ..... 190  
 Setting (climate control) ..... 119  
 Transmission oil (on-board computer, Mercedes-AMG vehicles) ..... 202
- Timing (RACETIMER)** ..... 203
- Tire pressure**  
 Calling up (on-board computer) ..... 299  
 Checking manually ..... 299  
 Display message ..... 227  
 Maximum ..... 299  
 Not reached (TIREFIT) ..... 281  
 Notes ..... 298  
 Reached (TIREFIT) ..... 281  
 Recommended ..... 296
- Tire pressure monitor**  
 Checking the tire pressure electronically ..... 301  
 Function/notes ..... 299  
 General notes ..... 299  
 Important safety notes ..... 300  
 Radio type approval for the tire pressure monitor ..... 302  
 Restarting ..... 301  
 Warning lamp ..... 242  
 Warning message ..... 301
- Tire-change tool kit** ..... 278
- TIREFIT kit** ..... 279  
 Important safety notes ..... 279  
 Storage location ..... 277  
 Tire pressure not reached ..... 281  
 Tire pressure reached ..... 281
- Tires**  
 Aspect ratio (definition) ..... 312  
 Average weight of the vehicle occupants (definition) ..... 311  
 Bar (definition) ..... 311  
 Changing a wheel ..... 313  
 Characteristics ..... 311  
 Checking ..... 293  
 Curb weight (definition) ..... 312  
 Definition of terms ..... 311  
 Direction of rotation ..... 313  
 Display message ..... 227  
 Distribution of the vehicle occupants (definition) ..... 313  
 DOT (Department of Transportation) (definition) ..... 311  
 DOT, Tire Identification Number (TIN) ..... 310  
 GAWR (Gross Axle Weight Rating) (definition) ..... 311  
 GVW (Gross Vehicle Weight) (definition) ..... 311  
 GVWR (Gross Vehicle Weight Rating) (definition) ..... 311  
 Important safety notes ..... 293  
 Increased vehicle weight due to optional equipment (definition) ..... 311  
 Information on driving ..... 293  
 Kilopascal (kPa) (definition) ..... 312

- Labeling (overview) ..... 307
- Load bearing index (definition) ..... 312
- Load index ..... 309
- Load index (definition) ..... 312
- M+S tires ..... 295
- Maximum load on a tire (definition) ..... 312
- Maximum loaded vehicle weight (definition) ..... 312
- Maximum permissible tire pressure (definition) ..... 312
- Maximum tire load ..... 310
- Maximum tire load (definition) ..... 312
- MOExtended tires ..... 295
- Optional equipment weight (definition) ..... 312
- Overview ..... 293
- PSI (pounds per square inch) (definition) ..... 312
- Replacing ..... 313
- Service life ..... 294
- Sidewall (definition) ..... 312
- Speed rating (definition) ..... 311
- Storing ..... 313
- Structure and characteristics (definition) ..... 311
- Summer tires ..... 295
- Temperature ..... 307
- TIN (Tire Identification Number) (definition) ..... 312
- Tire bead (definition) ..... 312
- Tire pressure (definition) ..... 312
- Tire pressures (recommended) ..... 311
- Tire size (data) ..... 318
- Tire size designation, load-bearing capacity, speed rating ..... 307
- Tire tread ..... 294
- Tire tread (definition) ..... 312
- Total load limit (definition) ..... 313
- Traction ..... 306
- Traction (definition) ..... 312
- Tread wear ..... 306
- Uniform Tire Quality Grading Standards ..... 306
- Uniform Tire Quality Grading Standards (definition) ..... 311
- Wear indicator (definition) ..... 313
- Wheel and tire combination ..... 318
- Wheel rim (definition) ..... 311
- see Flat tire
- Tow-starting**
  - Emergency engine starting ..... 290
  - Important safety notes ..... 288
- Towing**
  - Permitted towing methods ..... 289
- Towing away**
  - Important safety guidelines ..... 288
  - Installing the towing eye ..... 288
  - Removing the towing eye ..... 289
  - Transporting the vehicle ..... 290
  - With both axles on the ground ..... 289
  - With the rear axle raised ..... 290
- Traffic reports**
  - see also Digital Operator's Manual ..... 243
- Traffic Sign Assist**
  - Display message ..... 222
- Transmission**
  - Overview of transmission positions ..... 134
  - Selector lever ..... 134
  - see Automatic transmission
- Transmission position display** ..... 135
- Transporting the vehicle** ..... 290
- Trip computer (on-board computer)** ..... 193
- Trip odometer**
  - Calling up ..... 193
  - Resetting (on-board computer) ..... 194
- Trunk**
  - Emergency release ..... 86
  - Important safety notes ..... 81
  - Locking separately ..... 86
  - Opening/closing (automatically from inside) ..... 85
  - Opening/closing (automatically from outside) ..... 83
  - Opening/closing (from outside, HANDS-FREE ACCESS) ..... 84
  - Opening/closing (manually from outside) ..... 82
  - Overview ..... 81
  - Power closing ..... 81
- Trunk lid**
  - Display message ..... 230
  - Opening dimensions ..... 326

- Trunk partition**
- Display message ..... 230
  - General notes ..... 92
  - Installing ..... 93
  - Opening/closing ..... 93
  - Removing ..... 93
- Turn signals**
- Display message ..... 217
  - Switching on/off ..... 110
- Two-way radio**
- Frequencies ..... 319
  - Installation ..... 319
  - Transmission output (maximum) .... 319
- Type identification plate**
- see Vehicle identification plate
- U**
- Umbrella holder** ..... 250
- Unlocking**
- Emergency unlocking ..... 81
  - From inside the vehicle (central unlocking button) ..... 80
- Upshift indicator (on-board computer, Mercedes-AMG vehicles)** ..... 202
- USB devices**
- Connecting to the Media Interface ..... 248
- V**
- Vehicle**
- Correct use ..... 28
  - Data acquisition ..... 29
  - Display message ..... 228
  - Electronics ..... 319
  - Equipment ..... 25
  - Individual settings ..... 199
  - Limited Warranty ..... 29
  - Loading ..... 303
  - Locking (in an emergency) ..... 81
  - Locking (SmartKey) ..... 74
  - Lowering ..... 317
  - Maintenance ..... 26
  - Parking for a long period ..... 149
  - Pulling away ..... 128
  - Raising ..... 314
  - REACH Regulation ..... 28
  - Reporting problems ..... 29
  - Securing from rolling away ..... 314
  - Tow-starting ..... 288
  - Towing away ..... 288
  - Transporting ..... 290
  - Unlocking (in an emergency) ..... 81
  - Unlocking (SmartKey) ..... 74
  - Vehicle data ..... 326
- Vehicle battery**
- see Battery (vehicle)
- Vehicle data** ..... 326
- Vehicle dimensions** ..... 326
- Vehicle emergency locking** ..... 81
- Vehicle identification number**
- see VIN
- Vehicle identification plate** ..... 320
- Vehicle level**
- Active Body Control (ABC) (except Mercedes-AMG vehicles) .. 168
  - Active Body Control (ABC) (Mercedes-AMG vehicles) ..... 170
  - Display message ..... 221
- Vehicle tool kit** ..... 277
- Video**
- Operating the DVD ..... 196
  - see also Digital Operator's Manual ..... 243
- VIN**
- Seat ..... 321
  - Type plate ..... 320
- W**
- Warning and indicator lamps**
- ABS ..... 236
  - Active Brake Assist ..... 241
  - Brake Assist ..... 241
  - Brakes ..... 235
  - Check Engine ..... 239
  - Coolant ..... 239
  - Distance warning ..... 241
  - ESP® ..... 236
  - ESP® OFF ..... 237
  - Fuel tank ..... 239
  - General notes ..... 233
  - Parking brake ..... 238
  - PASSENGER AIR BAG ..... 41
  - Reserve fuel ..... 239
  - Restraint system ..... 238

- Seat belt ..... 233
- SPORT handling mode ..... 238
- Tire pressure monitor ..... 242
- Warning triangle** ..... 276
- Warranty** ..... 25
- Washer fluid**
  - Display message ..... 231
- Weather display (COMAND)**
  - see also Digital Operator's Manual ..... 243
- Wheel and tire combinations**
  - Tires ..... 318
- Wheel bolt tightening torque** ..... 317
- Wheel chock** ..... 314
- Wheels**
  - Changing a wheel ..... 313
  - Checking ..... 293
  - Cleaning ..... 274
  - Important safety notes ..... 293
  - Information on driving ..... 293
  - Interchanging/changing ..... 313
  - Mounting a new wheel ..... 316
  - Mounting a wheel ..... 313
  - Overview ..... 293
  - Removing a wheel ..... 316
  - Storing ..... 313
  - Tightening torque ..... 317
  - Wheel size/tire size ..... 318
- Wind screen**
  - Electrical wind screen ..... 94
- Windows**
  - see Side windows
- Windshield**
  - Defrosting ..... 120
- Windshield washer fluid**
  - see Windshield washer system
- Windshield washer system**
  - Adding washer fluid ..... 268
  - Important safety notes ..... 325
- Windshield wipers**
  - Display message ..... 231
  - Problem (malfunction) ..... 115
  - Replacing the wiper blades ..... 114
  - Switching on/off ..... 113
- Winter driving**
  - Important safety notes ..... 295
  - Slippery road surfaces ..... 153
  - Snow chains ..... 295
- Winter operation**
  - Overview ..... 295
- Winter tires**
  - M+S tires ..... 295
- Wiper blades**
  - Cleaning ..... 274
  - Important safety notes ..... 114
  - Replacing ..... 114
- Workshop**
  - see Qualified specialist workshop

## Z

### ZONE function

- Switching on/off ..... 120

## Introduction

The printed Operator's Manual provides information about the safe operation of your vehicle. The Digital Operator's Manual provides comprehensive and specifically adapted information on your vehicle's equipment and multimedia system. You can call up the Digital Operator's Manual via the multimedia system.

- i** You will not incur any costs when calling up the Digital Operator's Manual. The Digital Operator's Manual works without connecting to the Internet.

There are three ways to access the topics of the Digital Operator's Manual:

### • Visual search

The visual search allows you to explore your vehicle "virtually". Starting from either the vehicle exterior view or interior view, you can access many of the different topics covered by the Digital Operator's Manual. To access the vehicle interior section, select the "Vehicle interior" view.

### • Keyword search

The keyword search allows you to search for a keyword by entering characters.





### • Contents

You can select individual sections in the contents.

- i** The Digital Operator's Manual is deactivated for safety reasons while driving.

## Operation

### Calling up the Digital Operator's Manual

- ▶ Press the  button in the center console. The overview relating to the vehicle appears.
- ▶ Select the "Operator's Manual" menu item by turning  or pressing  the controller.
- ▶ Confirm  the message about the warning and safety notes. The basic menu for the Digital Operator's Manual appears.

## Operating the Digital Operator's Manual









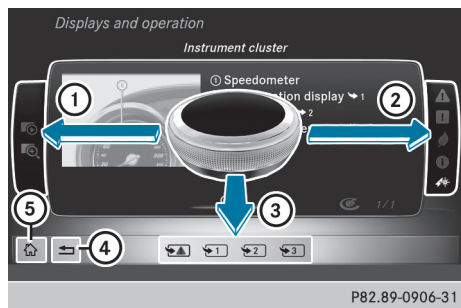





### General notes

Please observe the information about the operation of the controller ( page 244).

### Content pages

The content pages can be accessed by means of a visual search, a keyword search or using the contents.



- ▶ **To scroll forwards/backwards:** turn  the controller.
- ▶ **To display in full-screen or animation:** slide   the controller to the left .
- ▶ **To select information texts or save bookmarks:** slide   the controller to the right .
- ▶ **To select a link:** slide   the controller downwards .
- ▶ **To exit a content page:** select  symbol .
- ▶ **To call up the basic menu of the Digital Operator's Manual:** select  symbol .
- ▶ **To switch functions to the multimedia system using the buttons on the center console:** press the **RADIO**, **TEL**, **MEDIA** or **NAVI** button. The selected menu appears. The Digital Operator's Manual remains open in the background.



**Protecting the environment****General notes****🌀 Environmental note**

Daimler's declared policy is one of comprehensive environmental protection.

The objectives are for the natural resources that form the basis of our existence on this planet to be used sparingly and in a manner that takes the requirements of both nature and humanity into account.

You too can help to protect the environment by operating your vehicle in an environmentally responsible manner.

Fuel consumption and the rate of engine, transmission, brake and tire wear are affected by these factors:

- operating conditions of your vehicle
- your personal driving style

You can influence both factors. You should bear the following in mind:

Operating conditions:

- avoid short trips as these increase fuel consumption.
- always make sure that the tire pressures are correct.
- do not carry any unnecessary weight.
- remove roof racks once you no longer need them.
- a regularly serviced vehicle will contribute to environmental protection. You should therefore adhere to the service intervals.
- always have service work carried out at a qualified specialist workshop.

Personal driving style:

- do not depress the accelerator pedal when starting the engine.
- do not warm up the engine when the vehicle is stationary.
- drive carefully and maintain a safe distance from the vehicle in front.
- avoid frequent, sudden acceleration and braking.

- change gear in good time and use each gear only up to  $\frac{2}{3}$  of its maximum engine speed.
- switch off the engine in stationary traffic.
- keep an eye on the vehicle's fuel consumption.

**Environmental concerns and recommendations**

Wherever the operating instructions require you to dispose of materials, first try to regenerate or re-use them. Observe the relevant environmental rules and regulations when disposing of materials. In this way you will help to protect the environment.

**Genuine Mercedes-Benz parts****🌀 Environmental note**

Daimler AG also supplies reconditioned major assemblies and parts which are of the same quality as new parts. They are covered by the same Limited Warranty entitlements as new parts.

**!** Air bags and Emergency Tensioning Devices, as well as control units and sensors for these restraint systems, may be installed in the following areas of your vehicle:

- doors
- door pillars
- door sills
- seats
- cockpit
- instrument cluster
- center console

Do not install accessories such as audio systems in these areas. Do not carry out repairs or welding. You could impair the operating efficiency of the restraint systems.

Have aftermarket accessories installed at a qualified specialist workshop.

You could jeopardize the operating safety of your vehicle if you use parts, tires and wheels as well as accessories relevant to safety which

have not been approved by Mercedes-Benz. This could lead to malfunctions in safety-relevant systems, e.g. the brake system. Use only genuine Mercedes-Benz parts or parts of equal quality. Only use tires, wheels and accessories that have been specifically approved for your vehicle.

Genuine Mercedes-Benz parts are subject to strict quality control. Every part has been specifically developed, manufactured or selected for and adapted to Mercedes-Benz vehicles. Therefore, only genuine Mercedes-Benz parts should be used.

More than 300,000 different genuine Mercedes-Benz parts are available for Mercedes-Benz models.

All authorized Mercedes-Benz Centers maintain a supply of genuine Mercedes-Benz parts for necessary service and repair work. In addition, strategically located parts delivery centers provide quick and reliable parts service.

Always specify the vehicle identification number (VIN) when ordering genuine Mercedes-Benz parts (▷ page 320).

## Operator's Manual

### Vehicle equipment

**i** This Operator's Manual describes all models and all standard and optional equipment of your vehicle available at the time of going to print. Country-specific differences are possible. Bear in mind that your vehicle may not feature all functions described here.

This also applies to safety-relevant systems and functions. The equipment in your vehicle may therefore differ from that shown in the descriptions and illustrations.

The original purchase agreement lists all systems installed in your vehicle.

Should you have any questions concerning equipment and operation, please consult an authorized Mercedes-Benz Center.

The Operator's Manual and Maintenance Booklet are important documents and should be kept in the vehicle.

## Service and vehicle operation

### Warranty

The implied warranty for your vehicle applies in accordance with the warranty terms and conditions in the Service and Warranty Information booklet.

Your authorized Mercedes-Benz Center will replace and repair all factory-installed parts in accordance with the following warranty terms and conditions:

- New Vehicle Limited Warranty
- Emission System Warranty
- Emission Performance Warranty
- California, Connecticut, Maine, Massachusetts, New York, Pennsylvania, Rhode Island and Vermont Emission Control System Warranty
- State warranty enforcement laws (lemon laws)

Replacement parts and accessories are covered by the Mercedes-Benz Parts and Accessories warranties. These are available at any authorized Mercedes-Benz Center.

**i** Should you lose your Service and Warranty Information booklet, have an authorized Mercedes-Benz Center arrange for a replacement. The new Service and Warranty Information booklet will be posted to you.

### Information for customers in California

Under California law you may be entitled to a replacement of your vehicle or a refund of the purchase price or lease price, if after a reasonable number of repair attempts Mercedes-Benz USA, LLC and/or its authorized repair or service facilities fail to fix one or more substantial defects or malfunctions in the vehicle that are covered by its express warranty.

During the period of 18 months from original delivery of the vehicle or the accumulation of 29,000 km (approximately 18,000 miles) on the odometer of the vehicle, whichever occurs first, a reasonable number of repair attempts is presumed for a retail buyer or lessee if one or more of the following occurs:

- (1) the same substantial defect or malfunction results in a condition that is likely to

cause death or serious bodily injury if the vehicle is driven, that defect or malfunction has been subject to repair two or more times, and you have directly notified Mercedes-Benz USA, LLC in writing of the need for its repair.

- (2) the same substantial defect or malfunction of a less serious nature than category (1) has been subject to repair four or more times and you have directly notified Mercedes-Benz in writing of the need for its repair.
- (3) the vehicle is out of service by reason of repair of the same or different substantial defects or malfunctions for a cumulative total of more than 30 calendar days.

Please send your written notice to:  
Mercedes-Benz USA, LLC  
Customer Assistance Center  
One Mercedes-Benz Drive  
Sandy Springs, GA 30328

**Maintenance**

The Service and Warranty Booklet describes all the necessary maintenance work which should be done at regular intervals.

Always have the Service and Warranty Booklet with you when you bring the vehicle to an authorized Mercedes-Benz Center. The service advisor will record every service for you in the Service and Warranty Booklet.

**Roadside Assistance**

The Mercedes-Benz Roadside Assistance Program offers technical help in the event of a breakdown. Calls to the toll-free Roadside Assistance Hotline are answered by our agents 24 hours a day, 365 days a year.

**1-800-FOR-MERCEdes(1-800-367-6372) (USA)**

**1-800-387-0100 (Canada)**

For additional information, refer to the Mercedes-Benz Roadside Assistance Program brochure (USA) or the "Roadside Assistance" section in the Service and Warranty booklet (Canada). You will find both in your vehicle literature portfolio.

**Change of address or change of ownership**

In the event of a change of address, please send us the "Notification of Address Change" in the Service and Guarantee booklet or simply call the Mercedes-Benz Customer Assistance Center (USA) at the hotline number 1-800-FOR-MERCEdes(1-800-367-6372) or Customer Service Center (Canada) at 1-800-387-0100. This will assist us in contacting you in a timely manner should the need arise.

If you sell your Mercedes, please leave the entire literature in the vehicle so that it is available to the next owner.

If you have purchased a used car, please send us the "Notification of Used Car Purchase" in the Service and Guarantee booklet or simply call the Mercedes-Benz Customer Assistance Center (USA) at the hotline number 1-800-FOR-MERCEdes(1-800-367-6372) or Customer Service (Canada) at 1-800-387-0100.

**Vehicle operation outside the USA and Canada**

When you are abroad with your vehicle, observe the following points:

- Service facilities or replacement parts may not be readily available.
- Lead-free fuel for vehicles with a catalytic converter may not be available. Leaded fuel can cause damage to the catalytic converter.
- The fuel may have a considerably lower octane number. Unsuitable fuel can cause engine damage.

Some Mercedes-Benz models are available for delivery in Europe through our European Delivery Program. For details, consult an authorized Mercedes-Benz Center or write to one of the following addresses.

**In the USA**

Mercedes-Benz USA, LLC  
European Delivery Department  
One Mercedes-Benz Drive  
Sandy Springs, GA 30328

**In Canada**

Mercedes-Benz Canada, Inc.

European Delivery Department  
98 Vanderhoof Avenue  
Toronto, Ontario M4G 4C9

## Operating safety

### Important safety notes

#### WARNING

If you do not have the prescribed service/maintenance work or any required repairs carried out, this can result in malfunctions or system failures. There is a risk of an accident.

Always have the prescribed service/maintenance work as well as any required repairs carried out at a qualified specialist workshop.

#### WARNING

Flammable material such as leaves, grass or twigs may ignite if they come into contact with hot parts of the exhaust system. There is a risk of fire.

When driving on an unpaved road or off-road, check the vehicle underside regularly. In particular, remove trapped plant parts or other flammable material. Contact a qualified specialist workshop immediately if damage is detected.

#### WARNING

Modifications to electronic components, their software as well as wiring can impair their function and/or the function of other networked components. In particular, systems relevant to safety could also be affected. As a result, these may no longer function as intended and/or jeopardize the operating safety of the vehicle. There is an increased risk of an accident and injury.

Never tamper with the wiring as well as electronic components or their software. You should have all work to electrical and electronic equipment carried out at a qualified specialist workshop.

**!** There is a risk of damage to the vehicle if:

- the vehicle becomes stuck, e.g. on a high curb or an unpaved road
- you drive too fast over an obstacle, e.g. a curb, a speed bump or a pothole in the road
- a heavy object strikes the underbody or parts of the chassis

In situations like this, the body, the underbody, chassis parts, wheels or tires could be damaged without the damage being visible. Components damaged in this way can unexpectedly fail or, in the case of an accident, no longer withstand the loads they are designed to.

If the underbody paneling is damaged, combustible materials such as leaves, grass or twigs can gather between the underbody and the underbody paneling. If these materials come in contact with hot parts of the exhaust system, they can catch fire.

In such situations, have the vehicle checked and repaired immediately at a qualified specialist workshop. If on continuing your journey you notice that driving safety is impaired, pull over and stop the vehicle immediately, paying attention to road and traffic conditions. In such cases, consult a qualified specialist workshop.

### Declarations of conformity

#### Vehicle components which receive and/or transmit radio waves

**USA:** "The wireless devices of this vehicle comply with Part 15 of the FCC Rules. Operation is subject to the two following two conditions: 1) These devices may not cause harmful interference, and 2) These devices must accept any interference received, including interference that may cause undesired operation. Changes or modifications not expressly approved by the party responsible for compliance could void the user's authority to operate the equipment."

**Canada:** "The wireless devices of this vehicle comply with Industry Canada license-exempt RSS standard(s). Operation is subject to the following two conditions: (1) These devices may not cause interference, and (2) These devices must accept any interference, includ-

ing interference that may cause undesired operation of the device."

### Diagnostics connection

The diagnostics connection is used for connecting diagnostic equipment at a qualified specialist workshop.

#### WARNING

If you connect equipment to a diagnostics connection in the vehicle, it may affect the operation of vehicle systems. As a result, the operating safety of the vehicle could be affected. There is a risk of an accident.

Only connect equipment to a diagnostics connection in the vehicle, which is approved for your vehicle by Mercedes-Benz.

#### WARNING

Objects in the driver's footwell may restrict the clearance around the pedals or block a depressed pedal. This jeopardizes the operating and road safety of the vehicle. There is a risk of an accident.

Stow all objects securely in the vehicle so that they do not get into the driver's footwell. When using floor mats or carpets, make sure that they are properly secured so that they do not slip or obstruct the pedals. Do not place several floor mats or carpets on top of one another.

**!** If the engine is switched off and equipment on the diagnostics connection is used, the starter battery may discharge.

Connecting equipment to the diagnostics connection can lead to emissions monitoring information being reset, for example. This may lead to the vehicle failing to meet the requirements of the next emissions test during the main inspection.

### Qualified specialist workshop

An authorized Mercedes-Benz Center is a qualified specialist workshop. It has the necessary specialist knowledge, tools and qualifications to correctly carry out the work required

on your vehicle. This is especially the case for work relevant to safety.

Observe the notes in the Maintenance Booklet.

Always have the following work carried out at an authorized Mercedes-Benz Center:

- work relevant to safety
- service and maintenance work
- repair work
- alterations, installation work and modifications
- work on electronic components

### Correct use

If you remove any warning stickers, you or others could fail to recognize certain dangers. Leave warning stickers in position.

Observe the following information when driving your vehicle:

- the safety notes in this manual
- technical data for the vehicle
- traffic rules and regulations
- laws and safety standards pertaining to motor vehicles

### Information about the REACH decree

The REACH regulation (Regulation (EC) no. 1907/2006, Article 33) lays down an information obligation for substances of very high concern (SVHC).

Daimler AG acts in good faith to avoid using these SVHCs and to allow the customer to handle these substances safely. In accordance with supplier information and internal product information from Daimler AG, SVHCs that account for more than 0.1 percent by weight of individual products in this vehicle are known.

More detailed information can be found at the following addresses:

- <http://www.daimler.com/reach> (German version)
- <http://www.daimler.com/reach/en> (English version)

## Problems with your vehicle

If you should experience a problem with your vehicle, particularly one that you believe may affect its safe operation, we urge you to contact an authorized Mercedes-Benz Center immediately to have the problem diagnosed and rectified. If the problem is not resolved to your satisfaction, please discuss the problem again with an authorized Mercedes-Benz Center or, if necessary, contact us at one of the following addresses.

### In the USA

Mercedes-Benz USA, LLC  
Customer Assistance Center  
One Mercedes-Benz Drive  
Sandy Springs, GA 30328

### In Canada

Mercedes-Benz Canada, Inc.  
Customer Relations Department  
98 Vanderhoof Avenue  
Toronto, Ontario M4G 4C9

## Reporting safety defects

USA only:

The following text is published as required of manufacturers under Title 49, Code of U.S. Federal Regulations, Part 575 pursuant to the "National Traffic and Motor Vehicle Safety Act of 1966".

If you believe that your vehicle has a defect which could cause a crash or could cause injury or death, you should immediately inform the National Highway Traffic Safety Administration (NHTSA) in addition to notifying Mercedes-Benz USA, LLC.

If NHTSA receives similar complaints, it may open an investigation, and if it finds that a safety defect exists in a group of vehicles, it may order a recall and remedy campaign. However, NHTSA cannot become involved in individual problems between you, your dealer, or Mercedes-Benz USA, LLC.

To contact NHTSA, you may call the Vehicle Safety Hotline toll-free at 1-888-327-4236 (TTY: 1-800-424-9153); go to <http://www.safercar.gov>; or write to: Administrator, NHTSA, 400 Seventh Street, SW., Washington, DC 20590.

You can also obtain other information about motor vehicle safety from

<http://www.safercar.gov>

## Limited Warranty

! Observe the notes in this Operator's Manual regarding the correct operation of your vehicle and possible damage to the vehicle. Damage to the vehicle which is caused by violation of these notes is not covered by the Mercedes-Benz implied warranty or the new or used-vehicle warranty.

## QR code for rescue card

The QR codes are secured in the fuel filler flap and on the opposite side on the B-pillar. In the event of an accident, rescue services can use the QR code to quickly find the appropriate rescue card for your vehicle. The current rescue card contains the most important information about your vehicle in a compact form, e.g. the routing of the electric cables.

You can find more information at <http://www.mercedes-benz.de/qr-code>.

## Data storage

### Data storage

A wide range of electronic components in your vehicle contain data memories.

These data memories temporarily or permanently store technical information about:

- the vehicle's operating state
- incidents
- malfunctions

In general, this technical information documents the state of a component, a module, a system or the surroundings.

These include, for example:

- operating conditions of system components. For example, fluid levels
- the vehicle's status messages and those of its individual components, e.g. number of wheel revolutions/speed, deceleration in movement, lateral acceleration, accelerator pedal position



- malfunctions and defects in important system components, e.g. lights, brakes
- vehicle reactions and operating conditions in special driving situations, e.g. air bag deployment, intervention of stability control systems
- ambient conditions, e.g. outside temperature

This data is of an exclusively technical nature and can be used to:

- assist in recognizing and rectifying malfunctions and defects
- analyze vehicle functions, e.g. after an accident
- optimize vehicle functions

The data cannot be used to trace the vehicle's movements.

When your vehicle is serviced, technical information can be read from the event data memory and malfunction data memory.

Services include, for example:

- repair services
- service processes
- warranties
- quality assurance

The vehicle is read out by employees of the service network (including the manufacturer) using special diagnostic testers. More detailed information is obtained from it, if required.

After a malfunction has been rectified, the information is deleted from the malfunction memory or is continually overwritten.

When operating the vehicle, situations are conceivable in which this technical data, in connection with other information (if necessary, under consultation with an authorized expert), could be traced to a person.

Examples include:

- accident reports
- damage to the vehicle
- witness statements

Further additional functions that have been contractually agreed upon with the customer allow certain vehicle data to be conveyed by the vehicle as well. The additional functions include, for example, vehicle location in case of an emergency.

### COMAND/Mercedes me connect (Canada: TELEAID)

If the vehicle is equipped with COMAND or Mercedes me connect, additional data about the vehicle's operation, the use of the vehicle in certain situations, and the location of the vehicle is compiled through COMAND or the Mercedes me connect system.

For additional information, please refer to the COMAND User Manual or Digital Operator's Manual and/or the Mercedes me connect Terms and Conditions.

### Event data recorders

USA only:

This vehicle is equipped with an event data recorder (EDR). This vehicle is equipped with an event data recorder (EDR). The main purpose of an EDR is to record, in certain crash or near crash-like situations, such as an air bag deployment or hitting a road obstacle, data that will assist in understanding how a vehicle's systems performed. The EDR is designed to record data related to vehicle dynamics and safety systems for a short period of time, typically 30 seconds or less.

The EDR in this vehicle is designed to record such data as:

- How various systems in your vehicle were operating
- Whether or not the driver and passenger safety belts were buckled/fastened
- How far (if at all) the driver was depressing the accelerator and/or brake pedal; and,
- How fast the vehicle was traveling

These data can help provide a better understanding of the circumstances in which crashes and injuries occur. NOTE: EDR data are recorded by your vehicle only if a non-trivial crash situation occurs; no data are recorded by the EDR under normal driving conditions and no personal data (e.g. name, gender, age and crash location) are recorded. However, other parties, such as law enforcement could combine the EDR data with the type of personally identifying data routinely acquired during a crash investigation.

Access to the vehicle and/or the EDR is needed to read data that is recorded by an EDR, and special equipment is required. In addition

to the vehicle manufacturer, other parties that have the special equipment, such as law enforcement, can read the information by accessing the vehicle or the EDR.

EDR data may be used in civil and criminal matters as a tool in accident reconstruction, accident claims and vehicle safety. Since the Crash Data Retrieval CDR tool that is used to extract data from the EDR is commercially available, Mercedes-Benz USA, LLC ("MBUSA") expressly disclaims any and all liability arising from the extraction of this information by unauthorized Mercedes-Benz personnel.

MBUSA will not share EDR data with others without the consent of the vehicle owners or, if the vehicle is leased, without the consent of the lessee. Exceptions to this representation include responses to subpoenas by law enforcement; by federal, state or local government; in connection with or arising out of litigation involving MBUSA or its subsidiaries and affiliates; or, as required by law.

Warning: The EDR is a component of the Restraint System Module. Tampering with, altering, modifying or removing the EDR component may result in a malfunction of the Restraint System Module and other systems.

State laws or regulations regarding EDRs that conflict with federal regulation are pre-empted. This means that in the event of such conflict, the federal regulation governs. As of December 2016, 17 states have enacted laws relating to EDRs.

## Information on copyright

### General information

Information on license for free and open-source software used in your vehicle and its electronic components is available on the following website:

<http://www.mercedes-benz.com/opensource>

## Cockpit

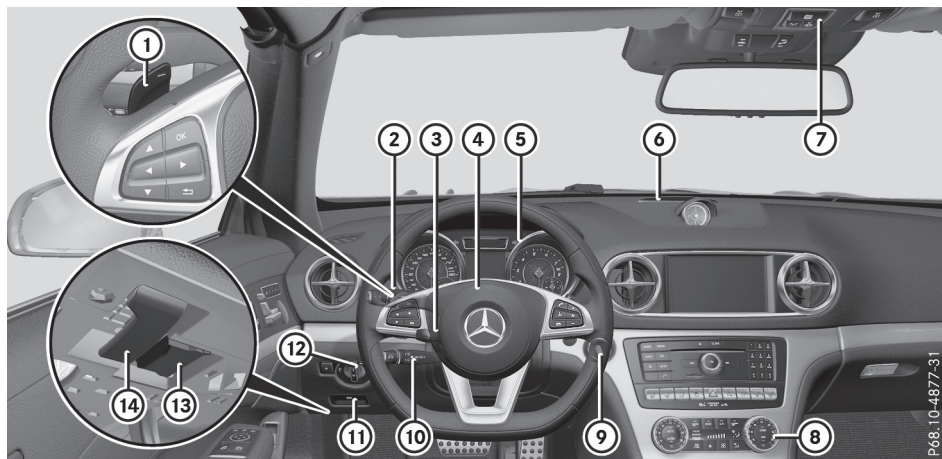

P68.10-4877-31

	Function	Page
①	Steering wheel paddle shifters	141
②	Combination switch	110
③	Adjusts the steering wheel electrically	103
④	Horn	
⑤	Instrument cluster	33
⑥	Parking Assist PARKTRONIC warning display	172
⑦	Overhead control panel	38

	Function	Page
⑧	Climate control systems	116
⑨	Ignition lock Start/Stop button	126
⑩	Cruise control lever	154
⑪	Electric parking brake	147
⑫	Light switch	109
⑬	Diagnostics connection	28
⑭	Opens the hood	265

## Instrument cluster

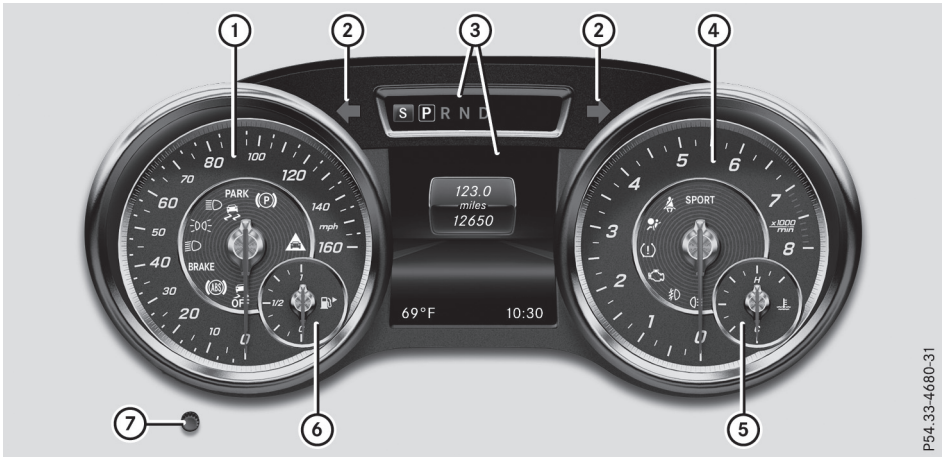

P54.33-4680-31

	Function	Page		Function	Page
①	Speedometer with segments Warning and indicator lamps: Electric parking brake (red) USA only Canada only Electric parking brake (yellow) Distance warning ESP® OFF ABS Brakes (red) USA only Canada only Low-beam headlamps Parking lamps High-beam headlamps ESP®	190 238 238 238 241 236 236 235 110 110 110 236		Warning and indicator lamps: SPORT handling mode in Mercedes-AMG vehicles This indicator lamp has no function This indicator lamp has no function Check Engine Tire pressure monitor Restraint system Seat belts	238 239 242 41 233
②	Turn signals	110	⑤	Coolant temperature gage Warning and indicator lamps: Coolant	191 239
③	Multifunction display	192	⑥	Fuel level indicator Warning and indicator lamps: Reserve fuel level with fuel filler flap location indicator (right)	239
④	Tachometer	190	⑦	Instrument cluster lighting	190





Information on displaying the outside temperature in the multifunction display can be found





under "Outside temperature display" (> page 190).

Multifunction steering wheel

At a glance



	Function	Page
①	Multifunction display	192
②	Multimedia system display	
③	 Switches on the Voice Control System  Mute  Adjusts the volume  Rejects or ends a call Exits the telephone book/redial memory  Makes or accepts a call Switches to the redial memory	196

	Function	Page
④	 Selects a menu  Selects a submenu or scrolls through lists  Confirms a selection Hides display messages  Back Switches off the Voice Control System	191

- i** In vehicles with multimedia system COMAND you can find further information:
- on the multimedia system in the Digital Operator's Manual
  - on the Voice Control System in the separate operating instructions

## Center console

## Center console, upper section



	Function	Page
①	COMAND	
②	Seat heating	101
③	Seat ventilation	102
④	AIRSCARF	102
⑤	Parking Assist PARKTRONIC	172

	Function	Page
⑥	Hazard warning lamps	111
⑦	Indicator lamp	48
⑧	ESP® (except Mercedes-AMG vehicles)	66
	ECO start/stop button (Mercedes-AMG vehicles)	129

**i** In vehicles with the COMAND multimedia system, you can find further information:



- on the multimedia system in the Digital Operator's Manual
- on the Voice Control System in the separate Operator's Manual

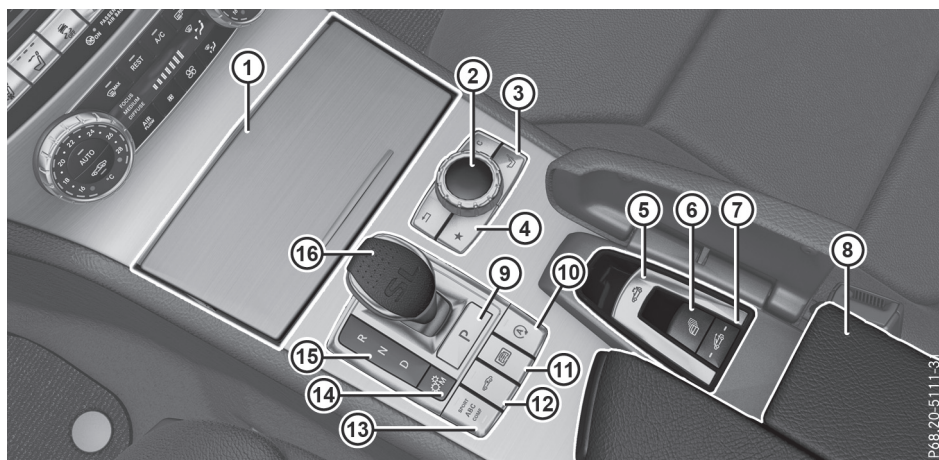

## Center console, lower section (except Mercedes-AMG vehicles)





	Function	Page
①	Storage compartment Cup holder Ashtray	250 252 254
②	COMAND controller	
③	Seat adjustment	
④	Favorites button	
⑤	Roof switch	91
⑥	Opens/closes the side windows	88
⑦	Extends/retracts the wind screen	94
⑧	Storage compartment with Media Interface Cigarette lighter	249
⑨	Selects park position	136

	Function	Page
⑩	 ECO start/stop button	129
⑪	Activates the driving dynamics display	168
⑫	 Adjusts the vehicle level (vehicles with Active Body Control)	168
⑬	Adjusts the suspension settings Sets the suspension tuning (vehicles with Active Body Control)	169
⑭	 Manual drive program for the automatic transmission	141
⑮	Transmission positions	137
⑯	Selector lever	134

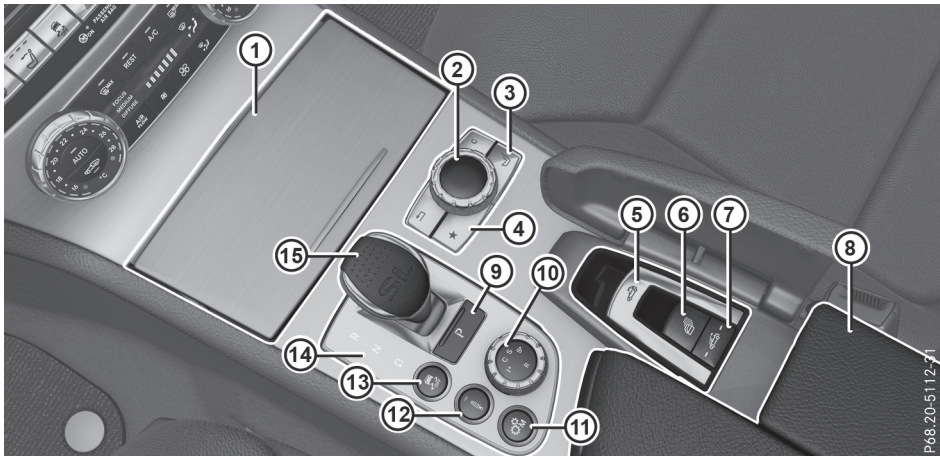

## Center console, lower section (Mercedes-AMG vehicles)



	Function	Page		Function	Page
①	Stowage compartment Cup holder Ashtray	250 252 254	⑨	Selects park position	136
②	COMAND controller		⑩	DYNAMIC SELECT controller	133
③	Seat adjustment		⑪	<b>M</b> Manual drive program for the automatic transmission	141
④	Favorites button		⑫	 Adjusts the suspension settings	171
⑤	Roof switch	91	⑬	 ESP®	66
⑥	Opens/closes the side windows	88	⑭	Transmission positions	137
⑦	Extends/retracts the wind screen	94	⑮	Selector lever	134
⑧	Stowage compartment with Media Interface Cigarette lighter	249			

## Overhead control panel

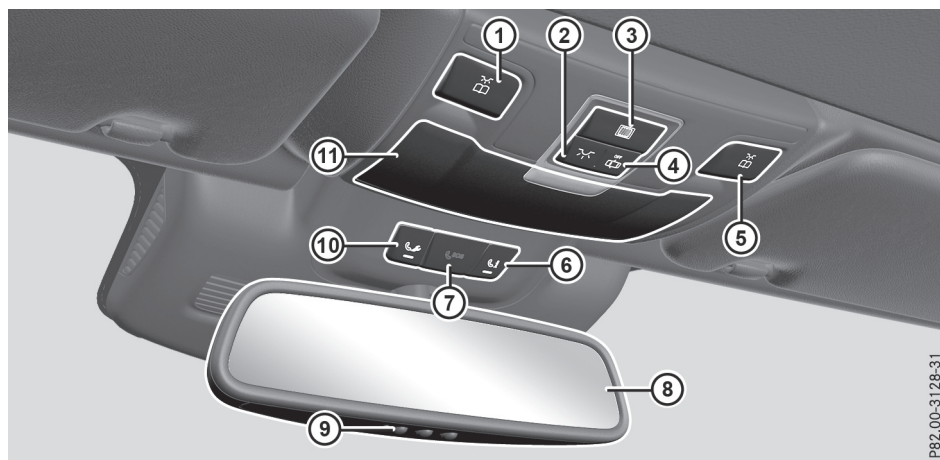

P82.00-3128-31

	Function	Page
①	Switches the left-hand reading lamp on/off	112
②	Switches the interior lighting on/off	112
③	Operates MAGIC SKY CONTROL	94
④	Switches the automatic interior lighting control on/off	112
⑤	Switches the right-hand reading lamp on/off	112

	Function	Page
⑥	MB Info call button	258
⑦	Emergency call/SOS button	256
⑧	Rear-view mirror	106
⑨	Buttons for the garage door opener	262
⑩	Breakdown assistance call button	257
⑪	Eyeglasses compartment	250

Door control panel

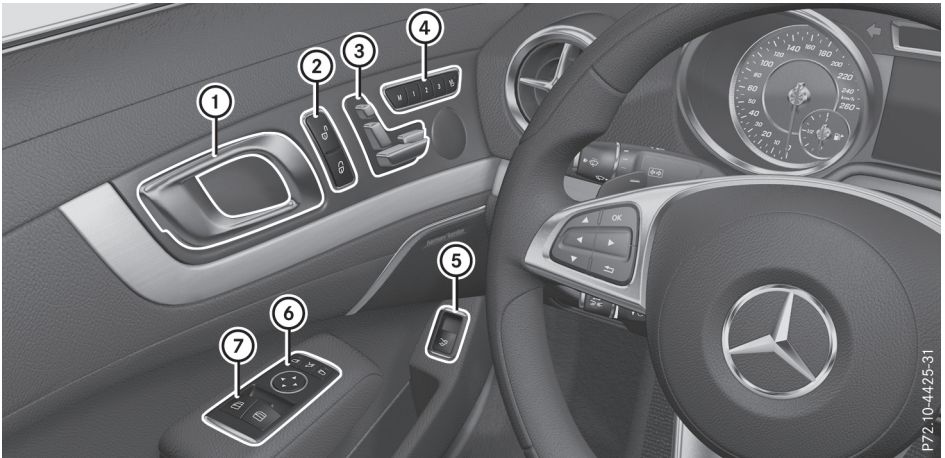

P72.10-4425-31

	Function	Page
①	Opens the door	80
②	Unlocks/locks the vehicle	80
③	Adjusts the seats	97
④	 Stores seat, exterior mirror and steering column adjustment settings	107
	Adjusts the front-passenger seat from the driver's seat	99

	Function	Page
⑤	Opens/closes the trunk lid	85
⑥	Adjusts the exterior mirrors electrically	105
⑦	Opens/closes the side windows	87

## Panic alarm

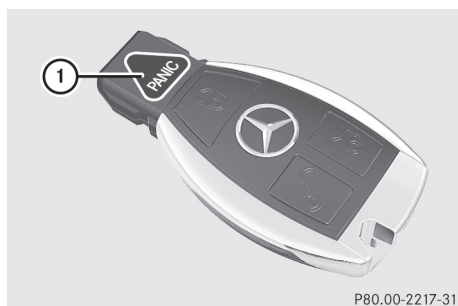

P80.00-2217-31

- ▶ **To activate:** press **PANIC** button ① for at least one second.  
A visual and audible alarm is triggered if the alarm system is armed.
- ▶ **To deactivate:** press **PANIC** button ① again.
- or
- ▶ Insert the SmartKey into the ignition lock.
- or
- ▶ Press the KEYLESS-GO Start/Stop button.  
The KEYLESS-GO key must be in the vehicle.

## Occupant safety

### Introduction to the restraint system

The restraint system can reduce the risk of vehicle occupants coming into contact with parts of the vehicle's interior in the event of an accident. The restraint system can also reduce the forces to which vehicle occupants are subjected during an accident.

The restraint system includes the following components:

- seat belt system
- air bags

The components of the restraint system work in conjunction with each other. They can only deploy their protective function if, at all times, all vehicle occupants:

- have fastened their seat belts correctly (▷ page 43)
- have the seat and head restraint adjusted properly (▷ page 97)

As the driver, you also have to make sure that the steering wheel is adjusted correctly.

Observe the information relating to the correct driver's seat position (▷ page 97).

You also have to make sure that an air bag can inflate properly if deployed (▷ page 45).

An air bag supplements a correctly worn seat belt. As an additional safety device, the air bag increases the level of protection for vehicle occupants in the event of an accident. For example, if, in the event of an accident, the protection offered by the seat belt is sufficient, the air bags are not deployed. When an accident occurs, only the air bags that increase protection in that particular accident situation are deployed. However, seat belts and air bags generally do not protect against objects penetrating the vehicle from the outside.

Information on restraint system operation can be found under "Triggering of the Emergency Tensioning Devices and air bags" (▷ page 53).

See "Children in the vehicle" for information on children traveling with you in the vehicle as well as on child restraint systems (▷ page 57).

### Important safety notes

#### WARNING

Modifications to the restraint system may cause it to no longer work as intended. The restraint system may then not perform its intended protective function and may fail in an accident or trigger unexpectedly, for example. This poses an increased risk of injury or even fatal injury.

Never modify parts of the restraint system. Never tamper with the wiring, the electronic components or their software.

If it is necessary to modify components of the restraint system to accommodate a person with disabilities, contact an authorized Mercedes-Benz Center for details. USA only: for further information contact our Customer Assistance Center at 1-800 FOR-MERCEDES (1-800-367-6372).

Mercedes-Benz recommends that you only use driving aids which have been approved specifically for your vehicle by Mercedes-Benz.

## Restraint system warning lamp

The functions of the restraint system are checked after the ignition is switched on and at regular intervals while the engine is running. Therefore, malfunctions can be detected in good time.

The  restraint system warning lamp on the instrument cluster lights up when the ignition is switched on. It goes out no later than a few seconds after the vehicle is started. The components of the restraint system are in operational readiness.

A malfunction has occurred if the  restraint system warning lamp:

- does not light up after the ignition is switched on
- does not go out after a few seconds with the engine running
- lights up again while the engine is running

### WARNING

If the restraint system is malfunctioning, restraint system components may be triggered unintentionally or may not deploy as intended during an accident. This can affect for example the Emergency Tensioning Device or the air bag. This poses an increased risk of injury or even fatal injury. Have the restraint system checked and repaired in a qualified specialist workshop as soon as possible.

## PASSENGER AIR BAG indicator lamp



PASSENGER AIR BAG ON indicator lamp ① and PASSENGER AIR BAG OFF indicator

lamp ② are part of the Occupant Classification System (OCS).

The indicator lamps display the status of the front-passenger front air bag.

- PASSENGER AIR BAG ON lights up for 60 seconds, subsequently both indicator lamps are off (PASSENGER AIR BAG ON and OFF): the front-passenger front air bag is able to deploy in the event of an accident.
- PASSENGER AIR BAG OFF lights up: the front-passenger front air bag is deactivated. It will then not be deployed in the event of an accident.

If the PASSENGER AIR BAG ON indicator lamp is off, only the PASSENGER AIR BAG OFF indicator lamp shows the status of the front-passenger front air bag. The PASSENGER AIR BAG OFF indicator lamp may be lit continuously or be off.

Depending on the person in the front-passenger seat, the front-passenger front air bag must either be deactivated or enabled; see the following points. You must make sure of this both before and during a journey.

- **Children in a child restraint system:** whether the front-passenger front air bag is enabled or deactivated depends on the installed child restraint system, and the age and size of the child. Therefore, be sure to observe the notes on the "Occupant Classification System (OCS)" (▷ page 48) and on "Children in the vehicle" (▷ page 57). There you will also find instructions on rearward and forward-facing child restraint systems on the front-passenger seat.
- **All other persons:** depending on the classification of the person in the front-passenger seat, the front-passenger front air bag is enabled or deactivated (▷ page 48). Be sure to observe the notes on "Seat belts" (▷ page 41) and "Air bags" (▷ page 45). There you can also find information on the correct seat position.

## Seat belts

### Introduction

Seat belts are the most effective means of restricting the movement of vehicle occupants in the event of an accident or the vehicle rolling over. This reduces the risk of vehicle occu-

pants coming into contact with parts of the vehicle interior or being ejected from the vehicle. Furthermore, the seat belt helps to keep the vehicle occupant in the best position in relation to the air bag.

The seat belt system comprises:

- Seat belts
- Emergency Tensioning Devices and seat belt force limiters

If the seat belt is pulled quickly or sharply by the seat belt guide, the inertia reel locks. The belt strap cannot be extracted any further.

The Emergency Tensioning Device tightens the seat belt in an accident, pulling the belt close against the body. However it does not pull the vehicle occupant back in the direction of the backrest.

The Emergency Tensioning Device does not correct an incorrect seat position or the routing of an incorrectly fastened seat belt.

When triggered, a seat belt force limiter helps to reduce the force exerted by the seat belt on the vehicle occupant.

The seat belt force limiters are synchronized with the front air bags which absorb part of the deceleration force. This can reduce the force exerted on the vehicle occupants during an accident.

**!** If the front-passenger seat is not occupied, do not engage the seat belt tongue in the buckle on the front-passenger seat. Otherwise, in the event of an accident the Emergency Tensioning Device and the side impact air bag, in addition to other systems, may be triggered and have to be replaced.

### Important safety notes

The use of seat belts and child restraint systems is required by law in:

- all 50 states
- the U.S. territories
- the District of Columbia
- all Canadian provinces

Even where this is not required by law, all vehicle occupants should correctly fasten their seat belts before starting the journey.

#### WARNING

If the seat belt is not worn correctly, it cannot perform its intended protective function.

An incorrectly fastened seat belt can also cause injuries, for example, in the event of an accident or when braking or changing direction abruptly. This poses an increased risk of injury or even fatal injury.

Always ensure that all vehicle occupants have their seat belts fastened correctly and are sitting properly.

The components of the restraint system work in conjunction with each other. They can only deploy their protective function if, at all times, all vehicle occupants:

- have fastened their seat belts correctly (▷ page 43)
- have the seat and head restraint adjusted properly (▷ page 97)

#### WARNING

The seat belt does not offer the intended level of protection if you have not moved the backrest to an almost vertical position.

When braking or in the event of an accident, you could slide underneath the seat belt and sustain abdomen or neck injuries, for example. This poses an increased risk of injury or even fatal injury.

Adjust the seat properly before beginning your journey. Always ensure that the backrest is in an almost vertical position and that the shoulder section of your seat belt is routed across the center of your shoulder.

#### WARNING

Persons less than 5 ft (1.50 m) tall cannot wear the seat belt correctly without an additional and suitable restraint system. If the seat belt is not worn correctly, it cannot perform its intended protective function. An incorrectly fastened seat belt can also cause injuries, for example, in the event of an accident or when braking or changing direction abruptly. This poses an increased risk of injury or even fatal injury.

For this reason, always secure persons under 5 ft (1.50 m) tall in suitable additional restraint systems.



If a child younger than twelve years old and under 5 ft (1.50 m) in height is traveling in the vehicle:

- always secure the child in a child restraint system suitable for this Mercedes-Benz vehicle. The child restraint system must be appropriate to the age, weight and size of the child.
- always observe the instructions and safety notes on "Children in the vehicle" (> page 57) in addition to the child restraint system manufacturer's installation and operating instructions
- always observe the instructions and safety notes on the "Occupant Classification System (OCS)" (> page 48)

### WARNING

The seat belts may not perform their intended protective function if:

- they are damaged, modified, extremely dirty, bleached or dyed
- the seat belt buckle is damaged or extremely dirty
- the Emergency Tensioning Devices, belt anchorages or inertia reels have been modified.

Seat belts may be damaged in an accident, although the damage may not be visible, e.g. due to splinters of glass. Modified or damaged seat belts may tear or fail, e.g. in an accident. Modified Emergency Tensioning Devices could accidentally trigger or fail to deploy when necessary. This poses an increased risk of injury or even fatal injury.

Never modify the seat belts, Emergency Tensioning Devices, belt anchorages and inertia reels. Make sure that the seat belts are undamaged, not worn out and clean. Following an accident, have the seat belts checked immediately at a qualified specialist workshop.

Only use seat belts that have been approved for your vehicle by Mercedes-Benz.

## Proper use of the seat belts

Observe the safety notes on the seat belt (> page 42).

Every vehicle occupant must observe the following notes to ensure a properly worn seat belt can provide full protection. Also make sure that all vehicle occupants are always wearing the seat belt correctly while the vehicle is in motion.

When fastening the seat belt, always make sure that:

- the seat belt buckle tongue is inserted only into the belt buckle belonging to that seat
- the seat belt is pulled tight across your body  
Avoid wearing bulky clothing, e.g. a winter coat.

- the seat belt is not twisted

Only then can the forces which occur be distributed over the area of the belt.

- the shoulder section of the belt is routed across the center of your shoulder

The shoulder section of the seat belt should not touch your neck or be routed under your arm or behind your back.

- the lap belt is taut and passes across your lap as low down as possible

The lap belt must always be routed across your hip joints and not across your abdomen. This applies particularly to pregnant women. If necessary, push the lap belt down to your hip joint and pull it tight using the shoulder section of the belt.

- the seat belt is not routed across sharp, pointed or fragile objects

If you have such items located on or in your clothing, e.g. pens, keys or eyeglasses, store these in a suitable place.

- only one person is using a seat belt

Infants and children must never travel sitting on the lap of a vehicle occupant. In the event of an accident, they could be crushed between the vehicle occupant and seat belt.

- objects are never secured with a seat belt if the seat belt is also being used by one of the vehicle's occupants

Also ensure that there are never objects between a person and the seat, e.g. cushions.

Seat belts are only intended to secure and restrain vehicle occupants. Always observe the notes in the "Stowage options/compartments"



section for securing objects, luggage or loads (▷ page 249).

### Fastening seat belts

Observe the safety notes on the seat belt (▷ page 42) and the notes on correct use of seat belts (▷ page 43).

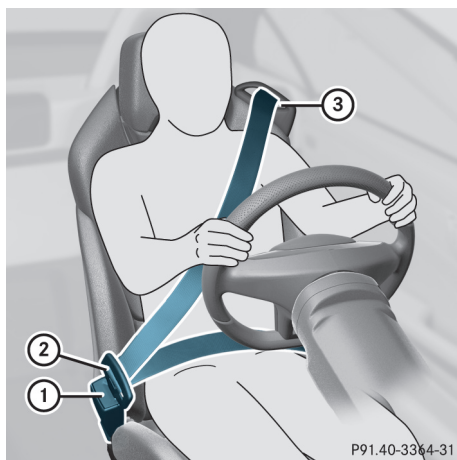

Basic illustration

- ▶ Adjust the seat (▷ page 97).  
The seat backrest must be in an almost upright position.
- ▶ Pull the seat belt smoothly out of seat belt guide ③ and engage belt tongue ② into belt buckle ①.  
The seat belt on the driver's seat and the front-passenger seat may be tightened automatically, see "Belt adjustment" (▷ page 44).
- ▶ If necessary, pull up on the shoulder section of the seat belt to tighten the belt across your body.

In order to attach the child restraint system securely in the vehicle, the seat belt on the front-passenger seat is equipped with a special seat belt retractor. Further information on the "Special seat belt retractor" (▷ page 57).

### Releasing seat belts

- ❗ Make sure that the seat belt is fully rolled up. Otherwise, the seat belt or belt tongue will be trapped in the door or in the seat mechanism. This could damage the door, the door trim panel and the seat belt. Dam-

aged seat belts can no longer fulfill their protective function and must be replaced. Visit a qualified specialist workshop.

- ▶ Press the release button in the belt buckle, hold the belt tongue firmly and guide the belt back.

### Seat belt adjustment

The belt adjustment is a convenience function integrated into PRE-SAFE®. With this function, the driver's and front-passenger seat belts are adjusted to the upper body of the vehicle occupant.

The seat belt strap will slightly tighten if:



- the belt tongue is inserted into the buckle and
- the ignition is switched on

The seat belt adjustment will apply a certain tightening force if any slack is detected between the vehicle occupant and the seat belt. Do not grab hold of the seat belt.

The belt adjustment can be switched on and off using the on-board computer (▷ page 202).

### Belt warning for the driver and front passenger

The  seat belt warning lamp in the instrument cluster is a reminder that all vehicle occupants must wear their seat belts. It may light up continuously or flash. In addition, there may be a warning tone.

Regardless of whether the driver's seat belt has already been fastened, the  seat belt warning lamp lights up for six seconds each time the engine is started. If the doors are closed and the driver's or front-passenger seat belt has not been fastened, the  seat belt warning lamp lights up again after the six seconds. As soon as the driver's and front-passenger seat belts are fastened or a front door is opened again, the  seat belt warning lamp goes out.

If the driver's seat belt is not fastened after the engine is started, an additional warning tone will sound. The warning tone switches off after six seconds or once the driver's seat belt is fastened.

If the vehicle's speed exceeds 15 mph (25 km/h) once and the driver's and front-

passenger seat belts are not fastened, a warning tone sounds. A warning tone also sounds with increasing intensity for 60 seconds or until the driver or front passenger have fastened their seat belts.

If the driver or front passenger unfasten their seat belts during the journey, the seat belt warning is activated again.

## Air bags

### Introduction

The installation point of an airbag can be recognized by the AIRBAG marking.

An airbag complements the correctly fastened seat belt. It is no substitute for the seat belt. When deployed, an airbag can increase the protection provided for the respective vehicle occupant.

Not all airbags are deployed in an accident. The various airbags work independently of each other (▷ page 53).

However, no system available today can completely eliminate injuries and fatalities.

It is also not possible to rule out a risk of injury caused by an airbag due to the high speed at which the airbag must be deployed.

### Important safety notes

#### WARNING

If you do not sit in the correct seat position, the air bag cannot protect as intended and could even cause additional injury when deployed. This poses an increased risk of injury or even fatal injury.

To avoid hazardous situations, always make sure that all of the vehicle's occupants:

- have fastened their seat belts correctly, including pregnant women
- are sitting correctly and maintain the greatest possible distance to the air bags
- follow the following instructions

Always make sure that there are no objects between the air bag and the vehicle's occupants.

All vehicle occupants must observe the following notes to avoid risks posed by the airbag when it deploys.

- Adjust the seats properly before beginning your journey. Always make sure that the seat is in an almost upright position. The center of the head restraint must support the head at about eye level.
- Move the driver's and front-passenger seats as far back as possible. The driver's seat position must allow the vehicle to be driven safely.
- Only hold the steering wheel on the outside. This allows the airbag to be fully deployed.
- Always lean against the backrest while driving. Do not lean forward or lean against the door or side window. You may otherwise be in the deployment area of the airbags.
- Always keep your feet in the footwell in front of the seat. Do not put your feet on the dashboard, for example. Your feet may otherwise be in the deployment area of the airbag.
- For this reason, always secure persons less than 5 ft (1.50 m) tall in suitable restraint systems. Up to this height, the seat belt cannot be worn correctly.

**If a child is traveling in your vehicle, also observe the following notes:**

- Always secure children under twelve years of age and less than 5 ft (1.50 m) tall in suitable child restraint systems.
- Secure a child to the front-passenger seat only when the front-passenger front airbag is deactivated, and then only in a rearward-facing child restraint system. The front-passenger front airbag is deactivated when the PASSENGER AIR BAG OFF indicator lamp is lit continuously (▷ page 41).
- Always observe the instructions and safety notes on the "Occupant Classification System (OCS)" (▷ page 48) and on "Children in the vehicle" (▷ page 57) in addition to the child restraint system manufacturer's installation and operating instructions.

**Objects in the vehicle interior may restrict the airbag from functioning correctly.** To avoid risks resulting from the speed of the airbag as it deploys, vehicle occupants must ensure the following points.

Before commencing your journey, ensure that:

- there are no people, animals or objects between the vehicle occupants and an air-bag
- there are no objects between the seat, door and B-pillar
- there are no hard objects, e.g. coat hangers, hanging on the grab handles or coat hooks
- no accessories, such as cup holders, are attached to the vehicle within the deployment area of an airbag, e.g. to doors or side windows
- no heavy, sharp-edged or fragile objects are in the pockets of your clothing. Store such objects in a suitable place

#### WARNING

If you modify the cover of an air bag or affix objects such as stickers to it, the air bag can no longer perform its intended function. There is an increased risk of injury.

Never modify the cover of an air bag or affix objects to it.

#### WARNING

Sensors to control the air bags are located in the doors. Modifications or work not performed correctly to the doors or door paneling, as well as damaged doors, can lead to the function of the sensors being impaired. The air bags might therefore not function properly anymore. Consequently, the air bags cannot protect vehicle occupants as they are designed to do. There is an increased risk of injury.

Never modify the doors or parts of the doors. Always have work on the doors or door paneling carried out at a qualified specialist workshop.

### Front air bags

- ❗ Do not place heavy objects on the front-passenger seat. This could cause the system to identify the seat as being occupied. In the event of an accident, the restraint systems on the front-passenger side may be triggered and have to be replaced.

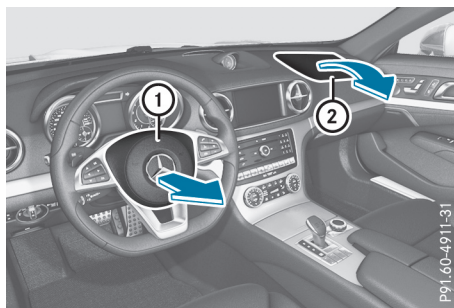

Driver's air bag ① deploys in front of the steering wheel. Front-passenger front air bag ② deploys in front of and above the glove box.

When deployed, the front air bags offer additional head and thorax protection for the occupants in the driver's and front-passenger seats.

The PASSENGER AIR BAG OFF indicator lamp informs you about the status of the front-passenger front air bag (> page 41).

The front-passenger front air bag will only deploy if:

- the system, based on the OCS weight sensor readings, detects that the front-passenger seat is occupied (> page 48). The PASSENGER AIR BAG OFF indicator lamp is not lit (> page 48)
- the restraint system control unit predicts a high accident severity

### Knee bags



Driver's knee bag ① deploys under the steering column and front-passenger knee bag ② under the glove box. The driver's and front-passenger knee bags are triggered together with the front air bags.

The driver's and front-passenger knee bags offer additional thigh, knee and lower leg protection.

## Side impact air bags

### WARNING

Unsuitable seat covers can obstruct or prevent deployment of the air bags integrated into the seats. Consequently, the air bags cannot protect vehicle occupants as they are designed to do. In addition, the operation of the occupant classification system (OCS) could be adversely affected. This poses an increased risk of injury or even fatal injury.

You should only use seat covers that have been approved for the respective seat by Mercedes-Benz.



Side impact air bags ① deploy next to the outer bolster of the seat backrest.

When deployed, the side impact air bag offers additional thorax protection. However, it does not protect the:

- head
- neck
- arms

If the restraint system control unit detects a side impact, the side impact air bag is deployed on the side on which the impact occurs.

The side impact air bag on the front passenger side deploys under the following conditions:

- the OCS system detects that the front passenger seat is occupied or
- the seat belt buckle tongue is engaged in the belt buckle of the front passenger seat

If the belt tongue is engaged in the belt buckle, the side impact air bag on the front passenger side deploys if an appropriate accident situation occurs. In this case, deployment is independent of whether the front passenger seat is occupied or not.

## Head air bags

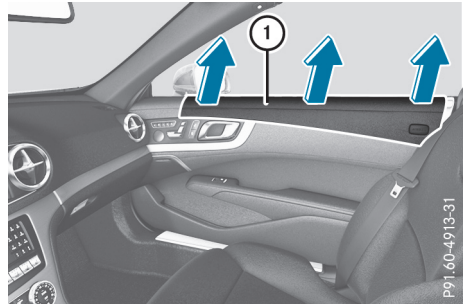

Head bags ① deploy in the area of the side windows at the front.

When deployed, the head bag enhances the level of protection for the head. However, it does not protect the:

- chest
- arms

If the restraint system control unit detects a side impact, the head bag is deployed on the side on which the impact occurs.

If the system determines that they can offer additional protection to that provided by the seat belt, a head bag may be deployed in other accident situations (▷ page 53).

The head bag on the front-passenger side deploys under the following conditions:

- the OCS system detects that the front-passenger seat is occupied or
- the seat belt buckle tongue is engaged in the belt buckle of the front-passenger seat

If the belt tongue is engaged in the belt buckle, the head bag on the front-passenger side deploys if an appropriate accident situation occurs. In this case, deployment is independent of whether the front-passenger seat is occupied or not.

## Occupant Classification System (OCS)

### Introduction

The Occupant Classification System (OCS) categorizes the person in the front-passenger seat. Depending on that result, the front-passenger front air bag and front-passenger knee bag are either enabled or deactivated.

The system does not deactivate:

- the side impact air bag
- the headbag
- the Emergency Tensioning Devices

### Requirements

To be classified correctly, the front passenger must sit:

- with the seat belt fastened correctly
- in an almost upright position with their back against the seat backrest
- with their feet resting on the floor, if possible

If the front passenger does not observe these conditions, OCS may produce a false classification, e.g. because the front passenger:

- transfers their weight by supporting themselves on a vehicle armrest
- sits in such a way that their weight is raised from the seat cushion

If you install a child restraint system on the front-passenger seat, be sure to observe the correct positioning of the child restraint system. Never place objects under or behind the child restraint system, e.g. a cushion. Fully retract the seat cushion length. The entire base of the child restraint system must always rest on the seat cushion of the front-passenger seat. The backrest of the forward-facing child restraint system must lie as flat as possible against the backrest of the front-passenger seat.

The child restraint system must not touch the roof or be subjected to a load by the head restraint. Adjust the angle of the seat backrest and the head restraint position accordingly.

Only then can OCS be guaranteed to function correctly. Always observe the child restraint system manufacturer's installation and operating instructions.

## Occupant Classification System operation (OCS)



- ① PASSENGER AIR BAG ON indicator lamp
- ② PASSENGER AIR BAG OFF indicator lamp

The indicator lamps inform you whether the front-passenger front air bag is deactivated or enabled.

- ▶ Press the Start/Stop button once or twice, or turn the SmartKey to position ① or ② in the ignition lock. The system carries out self-diagnostics.

The PASSENGER AIR BAG OFF and PASSENGER AIR BAG ON indicator lamps must light up simultaneously for approximately six seconds.

The indicator lamps display the status of the front-passenger front air bag.

- PASSENGER AIR BAG ON lights up for 60 seconds, subsequently both indicator lamps are off (PASSENGER AIR BAG ON and OFF): the front-passenger front air bag is able to deploy in the event of an accident.
- PASSENGER AIR BAG OFF lights up: the front-passenger front air bag is deactivated. It will then not be deployed in the event of an accident.

If the PASSENGER AIR BAG ON indicator lamp is off, only the PASSENGER AIR BAG OFF indicator lamp shows the status of the front-passenger front air bag. The PASSENGER AIR BAG OFF indicator lamp may be lit continuously or be off.

If the status of the front-passenger front air bag changes while the vehicle is in motion, an air bag display message appears in the instrument cluster (▷ page 215). When the front-passenger seat is occupied, always pay attention to the PASSENGER AIR BAG OFF indicator lamp. Be aware of the status of the front-



passenger front air bag both before and during the journey.

### WARNING

If the PASSENGER AIR BAG OFF indicator lamp is lit, the front-passenger front air bag is disabled. It will not be deployed in the event of an accident and cannot perform its intended protective function. A person in the front-passenger seat could then, for example, come into contact with the vehicle's interior, especially if the person is sitting too close to the dashboard. This poses an increased risk of injury or even fatal injury. When the front-passenger seat is occupied, always ensure that:

- the classification of the person in the front-passenger seat is correct and the front-passenger front air bag is enabled or disabled in accordance with the person in the front-passenger seat
- the front-passenger seat has been moved back as far back as possible.
- the person is seated correctly.

Make sure, both before and during the journey, that the status of the front-passenger front air bag is correct.

### WARNING

If you secure a child in a rearward-facing child restraint system on the front-passenger seat and the PASSENGER AIR BAG OFF indicator lamp is off, the front-passenger front air bag can deploy in the event of an accident. The child could be struck by the air bag. This poses an increased risk of injury or even fatal injury. Make sure that the front-passenger front air bag has been deactivated. The PASSENGER AIR BAG OFF indicator lamp must be lit. NEVER use a rearward-facing child restraint on a seat protected by an ACTIVE FRONT AIRBAG in front of it; DEATH or SERIOUS INJURY to the child can occur.

If the PASSENGER AIR BAG OFF indicator lamp stays off, do not install a rearward-facing child

restraint system on the front-passenger seat. You can find more information on OCS under "Problems with the Occupant Classification System" (> page 51).

### WARNING

If you secure a child in a forward-facing child restraint system on the front-passenger seat and you position the front-passenger seat too close to the dashboard, in the event of an accident, the child could:

- come into contact with the vehicle's interior if the PASSENGER AIR BAG OFF indicator lamp is lit, for example
- be struck by the air bag if the PASSENGER AIR BAG OFF indicator lamp is off

This poses an increased risk of injury or even fatal injury.

Always move the front-passenger seat as far back as possible and fully retract the seat cushion length. Always make sure that the shoulder belt strap is correctly routed from the vehicle seat belt guide to the shoulder belt guide on the child restraint system. The shoulder belt strap must be routed forwards and downwards from the seat belt guide. Always observe the child restraint system manufacturer's installation instructions.

If OCS determines that:

- The front-passenger seat is unoccupied, the PASSENGER AIR BAG OFF indicator lamp lights up after the self-test and remains lit. This indicates that the front-passenger front air bag is deactivated.
- The front-passenger seat is occupied by a child of up to twelve months old, in a standard child restraint system, the PASSENGER AIR BAG OFF indicator lamp lights up after the self-test and remains lit. This indicates that the front-passenger front air bag is deactivated.

But even in the case of a twelve-month-old child, in a standard child restraint system, the PASSENGER AIR BAG OFF indicator lamp can go out after the self-test. This indicates that the front-passenger front air bag is activated. The result of the classification is dependent on, among other factors, the

child restraint system and the child's stature. Make sure that the conditions for a correct classification are met. If the PASSENGER AIR BAG OFF indicator lamp remains off, do not install a child restraint system on the front-passenger seat.

- The front-passenger seat is occupied by a person of smaller stature (e.g. a teenager or small adult), the PASSENGER AIR BAG OFF indicator lamp either lights up and remains lit after the self-test depending on the result of the classification or, alternatively, goes out.
  - If the PASSENGER AIR BAG OFF indicator lamp is off, move the front-passenger seat as far back as possible.
  - If the PASSENGER AIR BAG OFF indicator lamp is lit, a person of smaller stature should not use the front-passenger seat.
- The front-passenger seat is occupied by an adult or a person of corresponding stature, the PASSENGER AIR BAG OFF indicator lamp goes out after the self-test. This indicates that the front-passenger front air bag is activated.

If children are traveling in the vehicle, be sure to observe the notes on "Children in the vehicle" (▷ page 57).

When the Occupant Classification System (OCS) is malfunctioning, the red  restraint system warning lamp on the instrument cluster and the PASSENGER AIR BAG OFF indicator lamp light up simultaneously. The front-passenger front air bag is deactivated in this case and does not deploy during an accident. Have the Occupant Classification System (OCS) checked and repaired immediately at a qualified specialist workshop. Mercedes-Benz recommends that you use an authorized Mercedes-Benz Center for this purpose.

If the front-passenger seat, the seat cover or the seat cushion are damaged, have the necessary repair work carried out at a qualified specialist workshop. Mercedes-Benz recommends that you use an authorized Mercedes-Benz Center for this purpose.

For safety reasons, Mercedes-Benz recommends that you only use seat accessories that have been approved by Mercedes-Benz.

Deployment of the driver's air bag does not mean that the front-passenger front air bag deploys as well. The Occupant Classification System (OCS) categorizes the occupant on the

front-passenger seat. Depending on that result, the front-passenger front air bag is either enabled or deactivated.

### Self-check of the occupant classification system (OCS)

#### DANGER

If the PASSENGER AIR BAG OFF and PASSENGER AIR BAG ON indicator lamps do not both light up during the self-test, the system is malfunctioning. The front-passenger front air bag might be triggered unintentionally or might not be triggered at all in the event of an accident with high deceleration. This poses an increased risk of injury or even fatal injury.

In this case the front-passenger seat may not be used. Do not install a child restraint system on the front-passenger seat. Have the Occupant Classification System (OCS) checked and repaired immediately at a qualified specialist workshop.

#### WARNING

If the PASSENGER AIR BAG OFF indicator lamp remains lit after the self-test, the front-passenger front air bag is deactivated. It will not be deployed in the event of an accident. In this case, the front-passenger front air bag cannot perform its intended protective function, e.g. when a person is seated in the front-passenger seat.

That person could, for example, come into contact with the vehicle's interior, especially if the person is sitting too close to the dashboard. This poses an increased risk of injury or even fatal injury.

When the front-passenger seat is occupied, always ensure that:

- the classification of the person in the front-passenger seat is correct and the front-passenger front air bag is enabled or



deactivated in accordance with the person in the front-passenger seat

- the person is seated properly with a correctly fastened seatbelt
- the front-passenger seat has been moved as far back as possible

If the PASSENGER AIR BAG OFF indicator lamp remains lit when it should not, the front-passenger seat must not be used. Do not install a child restraint system on the front-passenger seat. Have the Occupant Classification System (OCS) checked and repaired immediately at a qualified specialist workshop.

#### **WARNING**

Objects between the seat surface and the child restraint system could affect OCS operation. This could result in the front-passenger air bag not functioning as intended during an accident. This poses an increased risk of injury or even fatal injury.

Do not place any objects between the seat surface and the child restraint system. The

entire base of the child restraint system must always rest on the seat cushion of the front-passenger seat. The backrest of the forward-facing child restraint system must, as far as possible, be resting on the backrest of the front-passenger seat. Always comply with the child restraint system manufacturer's installation instructions.

After the self-test, the PASSENGER AIR BAG OFF or the PASSENGER AIR BAG ON indicator lamp displays the status of the front-passenger front airbag (> page 48). If the front-passenger front airbag is enabled, the PASSENGER AIR BAG ON indicator lamp lights up for 60 seconds and then goes out.

If the PASSENGER AIR BAG ON indicator lamp is off, only the PASSENGER AIR BAG OFF indicator lamp shows the status of the front-passenger front airbag. The PASSENGER AIR BAG OFF indicator lamp may be lit continuously or be off.

For more information about the OCS, see "Problems with the Occupant Classification System" (> page 51).

## **Problems with the Occupant Classification System (OCS)**

---

Be sure to observe the notes on "System self-test" (> page 50).

Problem	Possible causes/consequences and ► Solutions
<p>The PASSENGER AIR BAG OFF indicator lamp lights up and remains lit, even though the front-passenger seat is occupied by an adult or a person of a stature corresponding to that of an adult.</p>	<p>The classification of the person on the front-passenger seat is incorrect.</p> <ul style="list-style-type: none"> <li>► Make sure the conditions for a correct classification of the person on the front-passenger seat are met (► page 48).</li> <li>► If the PASSENGER AIR BAG OFF indicator lamp remains lit, the front-passenger seat may not be used.</li> <li>► Have OCS checked as soon as possible at an authorized Mercedes-Benz Center.</li> </ul>
<p>The PASSENGER AIR BAG OFF indicator lamp does not light up and/or does not stay on.</p> <p>The front-passenger seat is:</p> <ul style="list-style-type: none"> <li>• unoccupied</li> <li>• occupied by the weight of a child up to twelve months old in a child restraint system</li> </ul>	<p>OCS is malfunctioning.</p> <ul style="list-style-type: none"> <li>► Make sure there is nothing between the seat cushion and the child seat.</li> <li>► Make sure that the entire base of the child restraint system rests on the seat cushion of the front-passenger seat. The backrest of the forward-facing child restraint system must lie as flat as possible against the backrest of the front passenger seat. If necessary, adjust the position of the front-passenger seat.</li> <li>► Make sure that the seat cushion length is fully retracted.</li> <li>► When installing the child restraint system, make sure that the seat belt is tight. Do not pull the seat belt tight using the front-passenger seat adjustment. This could result in the seat belt and the child restraint system being pulled too tightly.</li> <li>► Check for correct installation of the child restraint system. Make sure that the head restraint does not apply a load to the child restraint system. If necessary, adjust the head restraint accordingly.</li> <li>► Make sure that no objects are applying additional weight onto the seat.</li> <li>► If the PASSENGER AIR BAG OFF indicator lamp remains off and/or the PASSENGER AIR BAG ON indicator lamp lights up, do not install a child restraint system on the front-passenger seat.</li> <li>► Have OCS checked as soon as possible at an authorized Mercedes-Benz Center.</li> </ul>

### Roll bar

#### DANGER

If the roll bar has developed a malfunction, it may not function, e.g. in the event of an accident. The roll bars may then not protect the vehicle occupants as intended. This poses an increased risk of injury or even fatal injury.

Have roll bars checked immediately at a qualified specialist workshop.

#### WARNING

If you place objects or clothing on the roll bar covers, these could impair roll bar extension. The roll bars may then not protect the vehicle occupants as intended. In addition, objects could endanger the vehicle occupants when the roll bar is extending. This poses an increased risk of injury or even fatal injury.

Ensure that the movement area of the roll bar covers is kept clear. Always stow all objects in the vehicle correctly.



The roll bars are located in the rear area of the vehicle under the two outer rear compartment trim covers.

They extend if systems detect that the vehicle is in danger of rollover. The two outer rear compartment trim covers are opened and the roll bars are extended within fractions of a second.

Once the roll bars are extended, you can no longer lower them. An open roof can no longer be closed. In this case, visit the nearest qualified specialist workshop.

### Deployment of Emergency Tensioning Devices and air bags

#### Important safety notes

##### WARNING

The air bag parts are hot after an air bag has been deployed. There is a risk of injury.

Do not touch the air bag parts. Have a deployed air bag replaced at a qualified specialist workshop as soon as possible.

##### WARNING

A deployed air bag no longer offers any protection and cannot provide the intended protection in an accident. There is an increased risk of injury.

Have the vehicle towed to a qualified specialist workshop in order to have a deployed air bag replaced.

For your own safety and that of your front passenger, it is important that you have deployed air bags replaced and defective air bags repaired. This will help to make sure the

air bags continue to perform their protective function for the vehicle occupants in the event of a crash.

##### WARNING

Emergency Tensioning Devices that have deployed pyrotechnically are no longer operational and are unable to perform their intended protective function. This poses an increased risk of injury or even fatal injury.

Have pyrotechnically triggered Emergency Tensioning Devices replaced immediately at a qualified specialist workshop.

An electric motor is used by PRE-SAFE® to trigger the tightening of the seat belt in hazardous situations. This procedure is reversible. If Emergency Tensioning Devices are triggered or air bags are deployed, you will hear a bang, and some powder may also be released. The  restraint system warning lamp lights up.

Only in rare cases will the bang affect your hearing. The powder that is released generally does not constitute a health hazard, but it may cause short-term breathing difficulties in people with asthma or other respiratory problems. Provided it is safe to do so, you should leave the vehicle immediately or open the window in order to prevent breathing difficulties.

Air bags and pyrotechnic Emergency Tensioning Devices (ETDs) contain perchlorate material, which may require special handling and regard for the environment. National guidelines must be observed during disposal. In California, see [www.dtsc.ca.gov/HazardousWaste/Perchlorate/index.cfm](http://www.dtsc.ca.gov/HazardousWaste/Perchlorate/index.cfm).

#### Method of operation

During the first stage of a collision, the restraint system control unit evaluates important physical data relating to vehicle deceleration or acceleration, such as:

- duration
- direction
- intensity

Based on the evaluation of this data, the restraint system control unit triggers the Emergency Tensioning Devices during a head-on or rear-end collision.

An Emergency Tensioning Device can only be triggered, if:

- the ignition is switched on
- the components of the restraint system are operational. You can find further information under "Restraint system warning lamp" (> page 41)
- the seat belt buckle tongue has engaged in the belt buckle of the respective seat

If the restraint system control unit detects a more severe accident, further components of the restraint system are activated independently of each other in certain frontal collision situations:

- Front air bags as well as driver's and front-passenger knee bags

Depending on the person in the front-passenger seat, the front-passenger front air bag is either enabled or disabled. The front-passenger front air bag can be deployed in an accident only if the PASSENGER AIR BAG OFF indicator lamp is off. Observe the information on the PASSENGER AIR BAG indicator lamps (> page 41).

Your vehicle has two-stage front air bags.

The activation threshold of the Emergency Tensioning Devices and the air bags is determined by evaluating the rate of vehicle deceleration or acceleration which occurs at various points in the vehicle. This process is pre-emptive in nature. Deployment should take place in good time at the start of the collision.

The rate of vehicle deceleration or acceleration and the direction of the force are essentially determined by:

- the distribution of forces during the collision
- the collision angle
- the deformation characteristics of the vehicle
- the characteristics of the object with which the vehicle has collided

Factors which can only be seen and measured after a collision has occurred do not play a decisive role in the deployment of an air bag. Nor do they provide an indication of air bag deployment.

The vehicle can be deformed considerably, without an air bag being deployed. This is the case if only parts which are relatively easily deformed are affected and the rate of deceleration is not high. Conversely, air bags may be deployed even though the vehicle suffers only

minor deformation. This is the case if, for example, very rigid vehicle parts such as longitudinal body members are hit, and sufficient deceleration occurs as a result.

If the restraint system control unit detects a side impact or if the vehicle rolls over, the applicable components of the restraint system are deployed independently of each other depending on the apparent type of accident.

- Side impact air bag on the side of impact, independently of the Emergency Tensioning Device and the use of the seat belt on the driver's seat

The side impact air bag on the front passenger side deploys under the following conditions:

- the OCS system detects that the front passenger seat is occupied or
- the seat belt buckle tongue is engaged in the belt buckle of the front passenger seat

- Head bag on the side of impact, independently of the use of the seat belt and independently of whether the front-passenger seat is occupied
- Emergency Tensioning Devices, if the system determines that deployment can offer additional protection in this situation
- Head bags on the driver's and front-passenger side in certain situations when the vehicle rolls over, if the system determines that deployment can offer additional protection to that provided by the seat belt

**i** Not all air bags are deployed in an accident. The different air bag systems work independently of each other.

How the air bag system works is determined by the severity of the accident detected, especially the vehicle deceleration or acceleration and the apparent type of accident:

- Head-on collision
- Side impact
- Rollover

## NECK-PRO head restraints

### Important safety notes

#### WARNING

The function of the head restraint may be impaired if you:

- attach objects such as coat hangers to the head restraints, for example
- use head restraint covers

If you do so, the head restraints cannot fulfill their intended protective function in the event of an accident. In addition, objects attached to the head restraints could endanger other vehicle occupants. There is an increased risk of injury.

Do not attach any objects to the head restraints and do not use head restraint covers.

### Method of operation

NECK-PRO head restraints reduce the likelihood of head and chest injuries. The NECK-PRO head restraints on the driver's and front-passenger seats are moved forwards and upwards in the event of a rear-end collision of a certain severity. This provides better head support.

If the NECK-PRO head restraints have been triggered in an accident, you must reset the NECK-PRO head restraints on the driver's and front-passenger seat (▷ page 55). Otherwise, the additional protection will not be available in the event of another rear-end collision. You can recognize when NECK-PRO head restraints have been triggered by the fact that they have moved forwards and can no longer be adjusted.

Mercedes-Benz recommends that you have the NECK-PRO head restraints checked for functionality at a qualified specialist workshop after a rear-end collision.

### Resetting triggered NECK-PRO head restraints

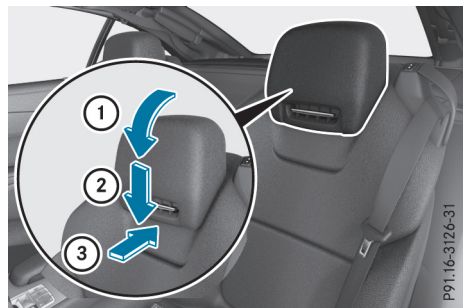

Do not insert your finger between the upholstery of the head restraint and the seat. Pay particular attention while resetting the NECK-PRO head restraints.

- ▶ Tilt the top of the NECK-PRO head restraint cushion forwards in the direction of arrow ①.
- ▶ Push the NECK-PRO head restraint cushion down as far as it will go in the direction of arrow ②.
- ▶ Firmly push the NECK-PRO head restraint cushion back in the direction of arrow ③ until the cushion engages.
- ▶ Repeat this procedure for the second NECK-PRO head restraint.

**i** Resetting the NECK-PRO head restraints requires a lot of strength. If you have difficulty resetting the NECK-PRO head restraints, have this work carried out at a qualified specialist workshop.

### PRE-SAFE® (anticipatory occupant protection system)

PRE-SAFE® informs you of certain critical driving situations and takes pre-emptive measures to protect the vehicle occupants.

PRE-SAFE® can take the following measures independently of each other:

- pre-tensioning the driver's and front-passenger seatbelt.
- closing the side windows.

- setting a more favorable seat position for the front-passenger seat.
- vehicles with a multicontour seat: increasing the air pressure in the side bolsters of the seat backrest.

**!** Make sure that there are no objects in the footwell or behind the seats. There is a danger that the seats and/or objects could be damaged when PRE-SAFE® is activated.

Should an accident not occur, the preventative measures taken are reversed. Certain settings must be made yourself.

- ▶ If the seat belt pre-tensioning is not reduced, move the seat backrest back slightly.  
Seat belt pre-tensioning is released.

### PRE-SAFE® PLUS (anticipatory occupant protection system PLUS)

#### Introduction

PRE-SAFE® PLUS is only available in vehicles with the Driving Assistance package.

Using the radar sensor system, PRE-SAFE® PLUS is able to detect that a head-on or rear-end collision is imminent. In certain hazardous situations, PRE-SAFE® PLUS takes pre-emptive measures to protect the vehicle occupants.

#### Important safety notes

The intervention of PRE-SAFE® PLUS cannot prevent an imminent collision.

The driver is not warned about the intervention of PRE-SAFE® PLUS.

PRE-SAFE® PLUS does not intervene if the vehicle is backing up.

When driving, or when parking or exiting a parking space using Active Parking Assist, PRE-SAFE® PLUS will not apply the brakes.

#### Function

PRE-SAFE® PLUS intervenes in certain situations if the radar sensor system detects an imminent head-on or rear-end collision.

PRE-SAFE® PLUS takes the following measures depending on the hazardous situation detected:

- if the radar sensor system detects that a head-on collision is imminent, the seat belts are pre-tensioned.
- if the radar sensor system detects that a rear-end collision is imminent:
  - the brake pressure is increased if the driver applies the brakes when the vehicle is stationary.
  - the seat belts are pre-tensioned.

The PRE-SAFE® PLUS braking application is canceled:

- if the accelerator pedal is depressed when a gear is engaged
- if the risk of a collision passes or is no longer detected
- if Active Distance Assist DISTRONIC indicates an intention to intervene

If the hazardous situation passes without resulting in an accident, the original settings are restored.

#### Automatic measures after an accident

Immediately after an accident, the following measures are implemented, depending on the type and severity of the impact:

- the hazard warning lamps are switched on
- the emergency lighting is activated
- the vehicle doors are unlocked
- the front side windows are lowered
- the electrically adjustable steering wheel is raised when the driver's door is opened
- the engine is switched off and the fuel supply is cut off
- vehicles with Mercedes me connect: automatic emergency call

## Children in the vehicle

### Important safety notes

If a child younger than twelve years old and under 5 ft (1.50 m) in height is traveling in the vehicle:

- always secure the child in a child restraint system suitable for Mercedes-Benz vehicles. The child restraint system must be appropriate to the age, weight and size of the child.
- be sure to observe the instructions and safety notes in this section in addition to the child restraint system manufacturer's installation instructions.
- always observe the instructions and safety notes on the "Occupant classification system (OCS)". (▷ page 48)

#### **WARNING**

If you leave children unsupervised in the vehicle, they could set it in motion by, for example:

- release the parking brake.
- shift the automatic transmission out of the parking position **P**.
- start the engine.

In addition, they may operate vehicle equipment and become trapped. There is a risk of an accident and injury.

When leaving the vehicle, always take the SmartKey with you and lock the vehicle. Never leave children unsupervised in the vehicle.

#### **WARNING**

If persons, particularly children are subjected to prolonged exposure to extreme heat or cold, there is a risk of injury, possibly even fatal. Never leave children unattended in the vehicle.

#### **WARNING**

If the child restraint system is subjected to direct sunlight, parts may get very hot. Children may burn themselves on these parts, particularly on the metal parts of the child restraint system. There is a risk of injury.

If you leave the vehicle, taking the child with you, always ensure that the child restraint system is not exposed to direct sunlight. Protect it with a blanket, for example. If the child restraint system has been exposed to direct sunlight, let it cool down before securing the child in it. Never leave children unattended in the vehicle.

Always ensure that all vehicle occupants have their seat belts fastened correctly and are sitting properly. Particular attention must be paid to children.

Observe the safety notes on the seat belt (▷ page 42) and the notes on correct use of seat belts (▷ page 43).

A booster seat may be necessary to achieve proper seat belt positioning for children over 40 lbs (18 kg) until they reach a height where a three-point seat belt can be properly fastened without a booster seat.

### Special seatbelt retractor

#### **WARNING**

If the seat belt is released while driving, the child restraint system will no longer be secured properly. The special seat belt retractor is disabled and the inertia reel draws in a portion of the seat belt. The seat belt cannot be immediately refastened. There is an increased risk of injury, possibly even fatal.

Stop the vehicle immediately, paying attention to road and traffic conditions. Reactivate the special seat belt retractor and secure the child restraint system properly.

The seat belt on the front-passenger's side is equipped with a special seat belt retractor. When activated, the special seat belt retractor ensures that the seat belt cannot slacken once the child seat is secured.



Installing a child restraint system:

- ▶ Make sure you observe the child restraint system manufacturer's installation instructions.
- ▶ Pull the seat belt smoothly out of the seat belt guide.
- ▶ Engage seat belt tongue in belt buckle.

Activating the special seat belt retractor:

- ▶ Pull the seat belt out fully and let the inertia reel retract it again.  
While the seat belt is retracting, you should hear a ratcheting sound. The special seat belt retractor is enabled.
- ▶ Push the child restraint system down so that the seat belt is tight and does not loosen.

Removing the child restraint system and deactivating the special seat belt retractor:

- ▶ Make sure you observe the child restraint system manufacturer's installation instructions.
- ▶ Press the release button of the seat belt buckle and route the seat belt tongue back towards the seat belt guide.  
The special seat belt retractor is deactivated.

### child restraint system

The use of seat belts and child restraint systems is required by law in:

- all 50 states
- the U.S. territories
- the District of Columbia
- all Canadian provinces

You can obtain further information about the correct child restraint system from any authorized Mercedes-Benz Center.

#### WARNING

If the child restraint system is installed incorrectly on a suitable seat, it cannot protect as intended. The child cannot then be restrained in the event of an accident, heavy braking or sudden changes of direction. There is an increased risk of injury, possibly even fatal.

Make sure that you observe the child restraint system manufacturer's installation

instructions and the notes on use. Please ensure, that the base of the child restraint system is always resting completely on the seat cushion. Never place objects, e.g. cushions, under or behind the child restraint system. Only use child restraint systems with the original cover designed for them. Only replace damaged covers with genuine covers.

#### WARNING

If the child restraint system is installed incorrectly or is not secured, it can come loose in the event of an accident, heavy braking or a sudden change in direction. The child restraint system could be thrown about, striking vehicle occupants. There is an increased risk of injury, possibly even fatal.

Always install child restraint systems properly, even if they are not being used. Make sure that you observe the child restraint system manufacturer's installation instructions.

Further information on stowing objects, luggage and loads securely can be found under "Stowing options/stowage compartments" (▷ page 249).

#### WARNING

Child restraint systems or their securing systems which have been damaged or subjected to a load in an accident can no longer protect as intended. The child cannot then be restrained in the event of an accident, heavy braking or sudden changes of direction. There is an increased risk of injury, possibly even fatal.

Replace child restraint systems which have been damaged or subjected to a load in an accident as soon as possible. Have the securing systems on the child restraint system checked at a qualified specialist workshop, before you install a child restraint system again.

The securing system of child restraint systems is the seat belt system.

If you install a child restraint system on the front passenger seat, be sure to observe the instructions and safety notes on the "Occupant Classification System (OCS)" (▷ page 48). There you will also find information on disabling the front passenger front air bag.

All child restraint systems must meet the following standards:

- U.S. Federal Motor Vehicle Safety Standards 213 and 225
- Canadian Motor Vehicle Safety Standards 213 and 210.2

Confirmation that the child restraint system corresponds to the standards can be found on an instruction label on the child restraint system. This confirmation can also be found in the installation instructions that are included with the child restraint system.

Observe the warning labels in the vehicle interior and on the child restraint system.

### Child restraint system on the front-passenger seat

#### General notes

If you install a child restraint system on the front-passenger seat, always observe the instructions and safety notes on the "Occupant Classification System (OCS)" (▷ page 48). You can thus avoid the risks that could arise as a result of:

- an incorrectly categorized person in the front-passenger seat
- deactivating the front passenger front air bag unintentionally
- the unsuitable positioning of the child restraint system, e.g. too close to the dashboard

#### Rearward-facing child restraint system

If circumstances require you to secure a child in a rearward-facing child restraint system on the front-passenger seat, always make sure that the front passenger front air bag is deactivated. Only if the PASSENGER AIR BAG OFF indicator lamp is lit continuously (▷ page 41), is the front passenger front air bag deactivated.

Always observe the child restraint system manufacturer's installation and operating instructions.

#### Forward-facing child restraint system

If you secure a child in a forward-facing child restraint system on the front-passenger seat, always move the front-passenger seat as far back as possible. Fully retract the seat cushion length. The entire base of the child restraint system must always rest on the seat cushion of the front-passenger seat. The backrest of the child restraint system must lie as flat as possible against the backrest of the front-passenger seat. The child restraint system must not touch the roof or be subjected to a load by the head restraint. Adjust the angle of the seat backrest and the head restraint position accordingly. Always make sure that the shoulder belt strap is correctly routed from the front-passenger seat belt guide to the shoulder belt guide on the child restraint system. The shoulder belt strap must be routed forward and down from the front-passenger seat belt guide. If necessary, adjust the front-passenger seat accordingly.

Always observe the child restraint system manufacturer's installation and operating instructions.

### Pets in the vehicle

#### WARNING

If you leave animals unsupervised or unsecured in the vehicle, they may press buttons or switches, for instance.

In this way, animals may:

- activate vehicle equipment and become trapped, for example
- switch systems on or off and thereby endanger other road users

Furthermore, unsecured animals may be flung around inside the vehicle in the event of an accident or abrupt steering or braking maneuver, and thereby injure vehicle occupants. There is a risk of accident and injury. Never leave animals unattended in the vehicle.

Always secure animals properly when driving, for instance with a suitable pet carrier.

## Driving safety systems

### Overview of driving safety systems

In this section, you will find information about the following driving safety systems:

- **ABS (Anti-lock Braking System)** (▷ page 60)
- **BAS (Brake Assist System)** (▷ page 61)
- Brake Assist with cross-traffic function (▷ page 61)
- Active Brake Assist (▷ page 63)
- Adaptive brake lights (▷ page 65)
- **ESP® (Electronic Stability Program)** (▷ page 65)
- **EBD (Electronic Brake force Distribution)** (▷ page 69)
- **ADAPTIVE BRAKE** (▷ page 70)
- Active Brake Assist with cross-traffic function (▷ page 70)
- **STEER CONTROL** (▷ page 72)

### Important safety notes

If you fail to adapt your driving style or if you are inattentive, the driving safety systems can neither reduce the risk of an accident nor override the laws of physics. Driving safety systems are merely aids designed to assist driving.

You are responsible for maintaining the distance to the vehicle in front, for vehicle speed, for braking in good time, and for staying in lane. Always adapt your driving style to suit the prevailing road and weather conditions and maintain a safe distance from the vehicle in front. Drive carefully.

The driving safety systems described only work as effectively as possible when there is adequate contact between the tires and the road surface. Pay particular attention to the information regarding tires, recommended minimum tire tread depths etc. in the "Wheels and tires" section (▷ page 293).

In wintry driving conditions, always use winter tires (M+S tires) and if necessary, snow

chains. Only in this way will the driving safety systems described in this section work as effectively as possible.

## ABS (Anti-lock Braking System)

### General information

ABS regulates brake pressure in such a way that the wheels do not lock when you brake. This allows you to continue steering the vehicle when braking.

The  ABS warning lamp in the instrument cluster lights up when the ignition is switched on. It goes out when the engine is running. ABS works from a speed of about 5 mph (8 km/h), regardless of road-surface conditions. ABS works on slippery surfaces, even when you only brake gently.

### Important safety notes

**i** Observe the "Important safety notes" section (▷ page 60).

#### **WARNING**

If ABS is malfunctioning, the wheels could lock when braking. The steerability and braking characteristics would be severely affected. There is an increased danger of skidding and accidents.

Drive on carefully. Have ABS checked immediately at a qualified specialist workshop.

When ABS is malfunctioning, other systems, including driving safety systems, will also become inoperative. Observe the information on the ABS warning lamp (▷ page 236) and display messages which may be shown in the instrument cluster (▷ page 206).

### Brakes

- ▶ **If ABS intervenes:** continue to depress the brake pedal vigorously until the braking situation is over.
- ▶ **To make a full brake application:** depress the brake pedal with full force.

If ABS intervenes when braking, you will feel a pulsing in the brake pedal.

The pulsating brake pedal can be an indication of hazardous road conditions, and functions as a reminder to take extra care while driving.

## BAS (Brake Assist System)

### General information

BAS operates in emergency braking situations. If you depress the brake pedal quickly, BAS automatically boosts the braking force, thus shortening the stopping distance.

### Important safety notes

- i** Observe the "Important safety notes" section (▷ page 60).

#### WARNING

If BAS is malfunctioning, the braking distance in an emergency braking situation is increased. There is a risk of an accident.

In an emergency braking situation, depress the brake pedal with full force. ABS prevents the wheels from locking.

### Braking

- ▶ Keep the brake pedal firmly depressed until the emergency braking situation is over. ABS prevents the wheels from locking.

The brakes will function as usual once you release the brake pedal. BAS is deactivated.

## Brake Assist with cross-traffic function

### General information

Brake Assist with cross-traffic function can help you to minimize the risk of a collision with a vehicle or a pedestrian and reduce the effects of such a collision. If Brake Assist with cross-traffic function detects a danger of collision, you are assisted when braking.

- i** Observe the "Important safety notes" section (▷ page 60).

Brake Assist with cross-traffic function is only available in vehicles with the Driving Assistance package.

For Brake Assist with cross-traffic function to assist you when driving, the radar sensor system and the camera system must be operational.

The sensor system and camera system help Brake Assist with cross-traffic function detect obstacles:

- that are in the path of your vehicle for an extended period of time
- that cross the path of your vehicle

In addition, pedestrians in the path of your vehicle can be detected.

Brake Assist with cross-traffic function detects pedestrians using typical characteristics such as body contours and the posture of a person standing upright.

If the radar sensor system or the camera system is malfunctioning, Brake Assist with cross-traffic function is restricted or no longer available. The brake system is still available with complete brake boosting effect and BAS.

- i** Observe the restrictions described in the "Important safety notes" section (▷ page 61).

### Important safety notes

#### WARNING

Active Brake Assist with cross-traffic function cannot always clearly identify objects and complex traffic situations.

In such cases, Active Brake Assist with cross-traffic function might:

- issue an unnecessary warning or brake
- issue no warning or not brake

Always pay careful attention to the traffic situation; do not rely on the Active Brake Assist with cross-traffic function alone.

Always be ready to brake and possibly take evasive action.

#### WARNING

Brake Assist with cross-traffic function cannot always clearly identify people, particularly if they are moving. Brake Assist with cross-traffic function cannot intervene in these cases. There is a risk of an accident.

Always pay careful attention to the traffic situation and be ready to brake.

### **WARNING**

Active Brake Assist with cross-traffic function does not react:

- to small people, e.g. children
- to animals
- to oncoming vehicles
- when cornering

As a result, Active Brake Assist with cross-traffic function may not warn you or engage in all critical situations. There is a risk of an accident.

Always pay careful attention to the traffic situation and be ready to brake.

In the event of snowfall or heavy rain, the recognition can be impaired.

Recognition by the radar sensor system is also impaired if:

- there is dirt on the sensors or anything else covering the sensors
- there is interference by other radar sources
- there are strong radar reflections, for example in parking garages
- a narrow vehicle is traveling in front, e.g. a motorbike
- a vehicle is traveling in front on a different line
- vehicles quickly move into the radar sensor system detection range

Recognition by the camera system is also impaired in the event of:

- dirt on the camera or if the camera is covered
- glare on the camera system, e.g. from the sun being low in the sky

- darkness
- or if:
  - pedestrians move quickly, e.g. into the path of the vehicle
  - the camera system no longer recognizes a pedestrian as a person due to special clothing or other objects
  - a pedestrian is concealed by other objects
  - the typical outline of a person is not distinguishable from the background

Following damage to the front end of the vehicle, have the configuration and operation of the radar sensors checked at a qualified specialist workshop. This also applies to collisions at slow speeds where there is no visible damage to the front of the vehicle.

Following damage to the windshield, have the configuration and operation of the camera system checked at a qualified specialist workshop.

## Function

To avoid a collision, Brake Assist with cross-traffic function calculates the brake force necessary if:

- you approach an obstacle, and
- Brake Assist with cross-traffic function has detected a risk of collision

### **When driving at a speed under 20 mph**

**(30 km/h):** if you depress the brake pedal, Brake Assist with cross-traffic function is activated. The increase in brake pressure will be carried out at the last possible moment.

### **When driving at a speed above 20 mph**

**(30 km/h):** if you depress the brake pedal sharply, Brake Assist with cross-traffic function automatically increases the brake pressure to a degree suited to the traffic situation.

Brake Assist with cross-traffic function provides braking assistance in hazardous situations with vehicles in front within a speed range between 4 mph (7 km/h) and 155 mph (250 km/h).

Up to a speed of approximately 44 mph (70 km/h), Brake Assist with cross-traffic function may react to:

- stationary objects in the path of your vehicle, e.g. stopped or parked vehicles
  - pedestrians in the path of your vehicle
  - obstacles crossing your path which move in the detection range of the sensors and are detected
- i** If Brake Assist with cross-traffic function requires a particularly high braking force, preventative passenger protection measures (PRE-SAFE®) are activated at the same time (▷ page 55).
- Keep the brake pedal depressed until the emergency braking situation is over. ABS prevents the wheels from locking.

Brake Assist with cross-traffic function is deactivated and the brakes function as usual again if:

- you release the brake pedal
- there is no longer a risk of collision
- no obstacle is detected in front of your vehicle
- you depress the accelerator pedal
- you activate kickdown

## Active Brake Assist

### General information

**i** Observe the "Important safety notes" section (▷ page 60).

Active Brake Assist consists of a distance warning function with an autonomous braking function and Adaptive Brake Assist.

Active Brake Assist can help you to minimize the risk of a collision with the vehicle in front or reduce the effects of such a collision.

If Active Brake Assist detects that there is a risk of collision, you will be warned visually and acoustically. If you do not react to the visual collision warning or the warning tone, autonomous braking can be initiated in critical situations. If you apply the brake yourself in a critical situation, Adaptive Brake Assist of the Active Brake Assist system supports you.

### Important safety notes

In particular, the detection of obstacles can be impaired if:

- there is dirt on the sensors or anything else covering the sensors
- there is snow or heavy rain
- there is interference by other radar sources
- there are strong radar reflections, for example in parking garages
- a narrow vehicle is traveling in front, e.g. a motorbike
- a vehicle is traveling in front on a different line
- you are driving a new vehicle or servicing on the Active Brake Assist system has just been carried out

Observe the important safety notes in the "Breaking-in notes" section (▷ page 125).

Following damage to the front end of the vehicle, have the configuration and operation of the radar sensor checked at a qualified specialist workshop. This also applies to collisions at slow speeds where there is no visible damage to the front of the vehicle.

### Activating/deactivating

Active Brake Assist is automatically active after switching on the ignition.

You can activate or deactivate Active Brake Assist using the on-board computer (▷ page 198). When deactivated, the distance warning function and the autonomous braking function are also deactivated.

If Active Brake Assist is deactivated, the  symbol appears in the assistance graphic display.

### Distance warning function

#### General information

The distance warning function can help you to minimize the risk of a front-end collision with a vehicle ahead or reduce the effects of such a collision. If the distance warning function detects that there is a risk of a collision, you will be warned visually and acoustically.

## Important safety notes

**i** Observe the "Important safety notes" section for driving safety systems (▷ page 60).

### WARNING

The distance warning function does not react:

- to people or animals
- to oncoming vehicles
- to crossing traffic
- when cornering

The distance warning function may not give warnings in all critical situations. There is a risk of an accident.

Always pay careful attention to the traffic situation and be ready to brake.

Always adapt your speed to suit the prevailing road and traffic conditions.

### WARNING

The distance warning function cannot always clearly identify objects and complex traffic situations.

In such cases, the distance warning function may:

- give an unnecessary warning
- not give a warning

There is a risk of an accident.

Always pay careful attention to the traffic situation and do not rely solely on the distance warning function.

## Function

Starting at a speed of approximately 4 mph (7 km/h), the distance warning function warns you if you rapidly approach a vehicle in front. An intermittent warning tone will then sound, and the  distance warning lamp will light up in the instrument cluster.

▶ Brake immediately in order to increase the distance from the vehicle in front.

or

▶ Take evasive action, provided it is safe to do so.

Due to the nature of the system, particularly complicated but non-critical driving conditions

may also cause the system to display a warning.

With the help of the radar sensor system, the distance warning function can detect obstacles that are in the path of your vehicle for an extended period of time.

Up to a speed of approximately 44 mph (70 km/h), the distance warning function can also react to stationary obstacles, such as stopped or parked vehicles.

## Autonomous braking function

If the driver does not react to the distance warning signal in a critical situation, Active Brake Assist can assist with the autonomous braking function.

If the autonomous braking function requires a particularly high braking force, preventative passenger protection measures (PRE-SAFE®) are activated simultaneously.

The autonomous braking function is available in the following speed ranges:

- 4 - 65 mph (7 - 105 km/h) for moving objects
- 4 - 31 mph (7 - 50 km/h) for stationary objects

Due to the nature of the system, particularly complicated but non-critical driving conditions may also cause the autonomous braking function to intervene.

If the autonomous braking function requires a particularly high braking force, preventative passenger protection measures (PRE-SAFE®) are activated simultaneously (▷ page 55).

## Adaptive Brake Assist

### General information

**i** Observe the "Important safety notes" section (▷ page 60).

With the help of Adaptive Brake Assist, the distance warning signal can detect obstacles that are in the path of your vehicle for an extended period of time.

If Adaptive Brake Assist detects a risk of collision with the vehicle in front, it calculates the braking force necessary to avoid a collision. If you apply the brakes forcefully, Adaptive Brake Assist will automatically increase the braking force to a level suitable for the traffic conditions.



Adaptive Brake Assist provides braking assistance in hazardous situations at speeds above 4 mph (7 km/h). It uses radar sensor technology to assess the traffic situation.

Up to a speed of approximately 155 mph (250 km/h), Adaptive Brake Assist is capable of reacting to moving objects that have already been detected as such at least once over the period of observation.

Up to a speed of approximately 44 mph (70 km/h), Adaptive Brake Assist reacts to stationary obstacles.

If Adaptive Brake Assist demands particularly high braking force, preventative passenger protection measures (PRE-SAFE®) are activated simultaneously (▷ page 55).

- ▶ Keep the brake pedal depressed until the emergency braking situation is over. ABS prevents the wheels from locking.

The brakes will work normally again if:

- you release the brake pedal
- there is no longer any danger of a collision
- no obstacle is detected in front of your vehicle

Adaptive Brake Assist is then deactivated.

### Important safety notes

#### WARNING

Adaptive Brake Assist cannot always clearly identify objects and complex traffic situations.

In such cases, Adaptive Brake Assist can:

- intervene unnecessarily
- not intervene

There is a risk of an accident.

Always pay careful attention to the traffic situation and be ready to brake. Terminate the intervention in a non-critical driving situation.

#### WARNING

Adaptive Brake Assist does not react:

- to people or animals
- to oncoming vehicles
- to crossing traffic
- when cornering

As a result, the Adaptive Brake Assist may not intervene in all critical conditions. There is a risk of an accident.

Always pay careful attention to the traffic situation and be ready to brake.

Always adapt your speed to suit the prevailing road and traffic conditions.

Due to the nature of the system, particularly complicated but non-critical driving conditions may also cause Adaptive Brake Assist to intervene.

If Adaptive Brake Assist is not available due to a malfunction in the radar sensor system, the brake system remains available with full brake boosting effect and BAS.

### Adaptive brake lights

-  Observe the "Important safety notes" section (▷ page 60).

If you brake sharply from a speed of more than 50 km/h or if braking is assisted by BAS or Brake Assist with Cross-Traffic Assist, the brake lamps flash rapidly. In this way, traffic traveling behind you is warned in an even more noticeable manner.

If you brake sharply from a speed of more than 70 km/h to a standstill, the hazard warning lamps are activated automatically. If the brakes are applied again, the brake lamps light up continuously. The hazard warning lamps switch off automatically if you travel faster than 10 km/h. You can also switch off the hazard warning lamps using the hazard warning button (▷ page 111).

### ESP® (Electronic Stability Program)

#### General notes

-  Observe the "Important safety notes" section (▷ page 60).

ESP® monitors driving stability and traction, i.e. power transmission between the tires and the road surface.

If ESP® detects that the vehicle is deviating from the direction desired by the driver, one or more wheels are braked to stabilize the vehicle. The engine output is also modified to keep

the vehicle on the desired course within physical limits. ESP® assists the driver when pulling away on wet or slippery roads. ESP® can also stabilize the vehicle during braking.

### ETS (Electronic Traction System)

- ⓘ Observe the "Important safety notes" section (▷ page 60).

ETS traction control is part of ESP®.

ETS brakes the drive wheels individually if they spin. This enables you to pull away and accelerate on slippery surfaces, for example if the road surface is slippery on one side. In addition, more drive torque is transferred to the wheel or wheels with traction.

ETS remains active when you deactivate ESP®.

- ⓘ **Mercedes-AMG vehicles:** your vehicle may be equipped with 20-inch tires on the rear axle. After changing to 19 inch wheels, ETS may intervene noticeably earlier during the first few kilometers. After approximately 10 km ETS will function as usual again. Information on the dimensions and types of wheels and tires for your vehicle can be found in the "Wheel/tire combinations" section (▷ page 318).

### Important safety notes

#### WARNING

If ESP® is malfunctioning it will not provide any vehicle stabilization. There is an increased risk of skidding or of an accident.

Exercise caution when continuing to drive.



Have ESP® checked at a qualified specialist workshop.

### The influence of drive programs on ESP®

The drive programs allow ESP® to adapt to different weather conditions, road conditions and the desired driving style. You can set the drive programs using the DYNAMIC SELECT button (▷ page 132) or on AMG vehicles using the DYNAMIC SELECT controller (▷ page 133).

When towing the vehicle with the rear axle raised, observe the notes on ESP® (▷ page 290).

If the  ESP® OFF warning lamp lights up continuously, then ESP® is deactivated.

If the  ESP® warning lamp and the  ESP® OFF warning lamp are lit continuously, ESP® is not available due to a malfunction.

Observe the information on warning lamps (▷ page 236) and display messages which may be shown in the instrument cluster (▷ page 206).

- ⓘ Only use wheels with the recommended tire sizes. Only then will ESP® function properly.

### Characteristics of ESP®

#### General information

If the  ESP® warning lamp goes out before beginning the journey, ESP® is automatically active.

If ESP® intervenes, the  ESP® warning lamp flashes in the instrument cluster.

If ESP® intervenes:

- ▶ Do not deactivate ESP® under any circumstances.
- ▶ Only depress the accelerator pedal as far as necessary when pulling away.
- ▶ Adapt your driving style to suit the prevailing road and weather conditions.

Drive program	ESP® mode	Characteristics
C Comfort E Economy	ESP® on	This drive program offers the best compromise between traction and stability. Select drive program <b>E</b> or <b>C</b> in difficult road conditions such as snow and ice or on wet roads.
S Sport	ESP® on	This drive program offers the best compromise between traction and stability.
S+ Sport Plus	ESP® Sport	The vehicle's own oversteering and understeering characteristics are emphasized. This enables a more active driving style. This drive program requires increased driver interaction. Select this drive program only when road conditions are good, e.g. the roads are dry and the route is clear.

Always adapt your driving style and drive program to the prevailing road and weather conditions. Additional information for drive programs (▷ page 138).

### ECO start/stop function

The ECO start/stop function switches the engine off automatically when the vehicle stops moving. The engine starts automatically when the driver wants to pull away again. ESP® remains in its previously selected status, e.g. if ESP® was deactivated before the engine was automatically switched off.

### Deactivating/activating ESP® (except Mercedes-AMG vehicles)

#### Important safety notes

**i** Observe the "Important safety notes" section (▷ page 60).

You can select between the following states of ESP®:

- ESP® is activated
- ESP® is deactivated

#### WARNING

If you deactivate ESP®, ESP® no longer stabilizes the vehicle. There is an increased risk of skidding and an accident.

Only deactivate ESP® in the situations described in the following.

It may be best to deactivate ESP® in the following situations:

- when using snow chains
- in deep snow
- on sand or gravel



Spinning the wheels results in a cutting action which provides better grip.

**i** Activate ESP® as soon as the situations described above no longer apply. ESP® will otherwise not be able to stabilize the vehicle if the vehicle starts to skid or a wheel starts to spin.

**!** Avoid spinning the driven wheels for an extended period with ESP® deactivated. You could otherwise damage the drivetrain.

### Deactivating/activating ESP®



- ▶ **To deactivate:** press button ①.  
The  ESP® OFF warning lamp in the instrument cluster lights up.
- ▶ **To activate:** press button ①.  
The  ESP® OFF warning lamp in the instrument cluster goes out.

### Characteristics when ESP® is deactivated

If ESP® is deactivated and one or more wheels start to spin, the  ESP® warning lamp in the instrument cluster flashes. In such situations, ESP® will not stabilize the vehicle.

If you deactivate ESP®:

- ESP® no longer improves driving stability
- engine torque is no longer limited and the drive wheels are able to spin
- traction control is still activated
- Active Brake Assist is no longer available; nor is it activated if you brake firmly with assistance from ESP®
- PRE-SAFE® is no longer available, nor is it activated if you brake firmly and ESP® intervenes
- Active Brake Assist with cross-traffic function is no longer available; nor is it activated if you brake firmly with assistance from ESP®
- ESP® still provides support when you brake firmly

### Deactivating/activating ESP® (Mercedes-AMG vehicles)

#### Important safety notes

**i** Observe the "Important safety notes" section (▷ page 60).

You can select between the following states of ESP®:

- ESP® is activated
- SPORT handling mode is activated
- ESP® is deactivated.

#### WARNING

When SPORT handling mode is activated, there is a greater risk of skidding and accidents.

Only activate SPORT handling mode in the situations described in the following.

#### WARNING

If you deactivate ESP®, ESP® no longer stabilizes the vehicle. There is an increased risk of skidding and an accident.

Only deactivate ESP® in the situations described in the following.

In the following situations, it may be better to activate SPORT handling mode or deactivate ESP®:

- when using snow chains
- in deep snow
- on sand or gravel
- on specially designated roads when the vehicle's own oversteering and understeering characteristics are desired

Spinning the wheels results in a cutting action which provides better grip.

Driving in SPORT handling mode or without ESP® requires an extremely qualified and experienced driver.

**i** Activate ESP® as soon as the situations described above no longer apply. ESP® will otherwise not be able to stabilize the vehicle if the vehicle starts to skid or a wheel starts to spin.

**!** Avoid spinning the driven wheels for an extended period with ESP® deactivated. You could otherwise damage the drivetrain.

### Deactivating/activating ESP®



- ▶ **To activate SPORT handling mode:** briefly press button ①. The **SPORT** SPORT handling mode warning lamp in the instrument cluster lights up. The **SPORT Handling Mode** message appears in the multifunction display.
- ▶ **To deactivate SPORT handling mode:** briefly press button ①. The **SPORT** SPORT handling mode warning lamp in the instrument cluster goes out.
- ▶ **To deactivate ESP®:** press button ① until the **ESP OFF** ESP® OFF warning lamp lights up in the instrument cluster. The **ESP OFF** message appears in the multifunction display.
- ▶ **To activate ESP®:** briefly press button ①. The **ESP OFF** ESP® OFF warning lamp in the instrument cluster goes out. The **ESP ON** message appears in the multifunction display.

### Characteristics of activated SPORT handling mode

If SPORT handling mode is activated and one or more wheels start to spin, the **ESP** ESP® warning lamp in the instrument cluster flashes. ESP® only stabilizes the vehicle to a limited degree.

When SPORT handling mode is activated:

- ESP® only improves driving stability to a limited degree
- traction control is still activated

- engine torque is no longer limited and the drive wheels are able to spin
- ESP® still provides support when you brake firmly

### Characteristics when ESP® is deactivated

If ESP® is deactivated and one or more wheels start to spin, the **ESP** ESP® warning lamp in the instrument cluster flashes. In such situations, ESP® will not stabilize the vehicle.

If you deactivate ESP®:

- ESP® no longer improves driving stability
- engine torque is no longer limited and the drive wheels are able to spin
- traction control is still activated
- Active Brake Assist is no longer available; nor is it activated if you brake firmly with assistance from ESP®
- PRE-SAFE® is no longer available, nor is it activated if you brake firmly and ESP® intervenes
- Active Brake Assist with cross-traffic function is no longer available; nor is it activated if you brake firmly with assistance from ESP®
- ESP® still provides support when you brake firmly

### EBD (electronic brake force distribution)

#### General information

EBD monitors and controls the brake pressure on the rear wheels to improve driving stability while braking.

#### Important safety notes

**i** Observe the "Important safety notes" section for driving safety systems (▷ page 60).

#### **⚠ WARNING**

If EBD is malfunctioning, the rear wheels can lock, e.g. under full braking. This increases the risk of skidding and an accident.

You should therefore adapt your driving style to the different handling characteris-

tics. Have the brake system checked at a qualified specialist workshop.

Observe information regarding indicator and warning lamps (> page 236) as well as display messages (> page 208).

## ADAPTIVE BRAKE

**i** Observe the "Important safety notes" section (> page 60).

ADAPTIVE BRAKE enhances braking safety and offers increased braking comfort. In addition to the braking function, ADAPTIVE BRAKE also has the HOLD function (> page 165) and hill start assist (> page 129).

## Active Brake Assist with cross-traffic function

### General information

Active Brake Assist with cross-traffic function can help you to minimize the risk of a collision with the vehicle in front or a pedestrian. Active Brake Assist with cross-traffic function can also reduce the effects of such a collision. If Active Brake Assist with cross-traffic function has detected a risk of collision, you will be warned visually and acoustically as well as by automatic braking.

**i** Pay attention to the important safety notes in the "Driving safety systems" section (> page 60).

Active Brake Assist with cross-traffic function is only available in vehicles with the Driving Assistance Plus package.

For Active Brake Assist with cross-traffic function to assist you when driving, the radar sensor system and the camera system must be operational.

The radar sensor system and camera system help Active Brake Assist with cross-traffic function to detect obstacles that are in the path of your vehicle for an extended period of time.

In addition, pedestrians in the path of your vehicle can be detected.

Active Brake Assist with cross-traffic function detects pedestrians using typical characteris-

tics such as body contours and the posture of a person standing upright.

**i** Observe the restrictions described in the "Important safety notes" section (> page 70).

## Important safety notes

### WARNING

Active Brake Assist with cross-traffic function will initially brake your vehicle by a partial application of the brakes if a danger of collision is detected. There may be a collision unless you brake yourself. Even after subsequent full application of the brakes a collision cannot always be avoided, particularly when approaching at too high a speed. There is a risk of an accident.

Always apply the brakes yourself and try to take evasive action, provided it is safe to do so.

If you partially apply the brakes, the vehicle is braked with up to 50% of the full braking force.

### WARNING

Active Brake Assist with cross-traffic function cannot always clearly identify objects and complex traffic situations.

In such cases, Active Brake Assist with cross-traffic function might:

- give an unnecessary warning and then brake the vehicle
- neither give a warning nor intervene

There is a risk of an accident.

Always pay particular attention to the traffic situation and be prepared to brake, especially if Active Brake Assist with cross-traffic function alerts you. Terminate the intervention in a non-critical driving situation.

### WARNING

Active Brake Assist with cross-traffic function cannot always clearly identify people, particularly if they are moving. Active Brake Assist with cross-traffic function cannot

intervene in these cases. There is a risk of an accident.

Always pay particular attention to the traffic situation and be prepared to brake, especially if Active Brake Assist with cross-traffic function alerts you.

In order to maintain the appropriate distance to the vehicle in front and thus prevent a collision, you must apply the brakes yourself.

### WARNING

Active Brake Assist with cross-traffic function does not react:

- to small people, e.g. children
- to animals
- to oncoming vehicles
- when cornering

As a result, Active Brake Assist with cross-traffic function may not warn you or engage in all critical situations. There is a risk of an accident.

Always pay careful attention to the traffic situation and be ready to brake.

In the event of snowfall or heavy rain, the recognition can be impaired.

Recognition by the radar sensor system is also impaired if:

- there is dirt on the sensors or anything else covering the sensors
- there is interference by other radar sources
- there are strong radar reflections, for example in parking garages
- a narrow vehicle is traveling in front, e.g. a motorbike
- a vehicle is traveling in front on a different line

Recognition by the camera system is also impaired in the event of:

- dirt on the camera or if the camera is covered
- glare on the camera system, e.g. from the sun being low in the sky

- darkness
- or if:
  - pedestrians move quickly, e.g. into the path of the vehicle
  - the camera system no longer recognizes a pedestrian as a person due to special clothing or other objects
  - a pedestrian is concealed by other objects
  - the typical outline of a pedestrian is not distinguishable from the background

Following damage to the front end of the vehicle, have the configuration and operation of the radar sensors checked at a qualified specialist workshop. This also applies to collisions at slow speeds where there is no visible damage to the front of the vehicle.

Following damage to the windshield, have the configuration and operation of the camera system checked at a qualified specialist workshop.

## Function

► **To activate or deactivate:** activate or deactivate Active Brake Assist with cross-traffic function using the on-board computer (> page 198).

When Active Brake Assist with cross-traffic function is deactivated, the  symbol appears in the assistance graphic display of the multifunction display.

Starting at a speed of around 4 mph (7 km/h), this function warns you if you rapidly approach a vehicle in front. An intermittent warning tone will then sound and the  distance warning lamp will light up in the instrument cluster.

► Brake immediately to defuse the situation.

or

► Take evasive action provided it is safe to do so.

Active Brake Assist with cross-traffic function can also brake the vehicle automatically under the following conditions:

- the driver and front passenger have their seat belts fastened and
- the vehicle speed is between approximately 4 mph (7 km/h) and 124 mph (200 km/h)



Up to a speed of approximately 44 mph (70 km/h), Active Brake Assist with cross-traffic function may react to:

- stationary objects in the path of your vehicle, e.g. stopped or parked vehicles
- pedestrians in the path of your vehicle

**i** If there is an increased risk of a collision, preventive passenger protection measures (PRE-SAFE®) are triggered (▷ page 55).

If the risk of collision with the vehicle in front remains and you do not brake, take evasive action or accelerate significantly, the vehicle may perform automatic emergency braking, up to the point of full brake application. Automatic emergency braking is not performed until immediately prior to an imminent accident.

You can prevent the intervention of Active Brake Assist with cross-traffic function at any time by:

- depressing the accelerator pedal further
- activating kickdown
- releasing the brake pedal

The braking application of Active Brake Assist with cross-traffic function is ended automatically if:

- you maneuver to avoid the obstacle
- there is no longer a risk of collision
- an obstacle is no longer detected in front of your vehicle

## STEER CONTROL

### General information

STEER CONTROL helps you by transmitting a noticeable steering force to the steering wheel in the direction required for vehicle stabilization.

This steering assistance is provided in particular if:

- both right wheels or both left wheels are on a wet or slippery road surface when you brake
- the vehicle starts to skid

## Important safety notes

**i** Observe the "Important safety notes" section (▷ page 60).

No steering support is provided from STEER CONTROL, if:

- ESP® is deactivated
- ESP® is malfunctioning
- the steering is faulty

If ESP® is malfunctioning, you will be assisted further by the electrical power steering.

## Protection against theft

### Immobilizer

- ▶ **To activate with the SmartKey:** remove the SmartKey from the ignition lock.
- ▶ **To activate with KEYLESS-GO:** switch the ignition off and open the driver's door.
- ▶ **To deactivate:** switch on the ignition.

The immobilizer prevents your vehicle from being started without the correct SmartKey.

When leaving the vehicle, always take the SmartKey with you and lock the vehicle. The engine can be started by anyone with a valid SmartKey that is left inside the vehicle.

**i** The immobilizer is always deactivated when you start the engine.

In the event that the engine cannot be started (yet the vehicle's battery is charged), the system is not operational. Contact an authorized Mercedes-Benz Center or call 1-800-FOR-MERCEDES (in the USA) or 1-800-387-0100 (in Canada).

## ATA (anti-theft alarm system)



- ▶ **To arm:** lock the vehicle with the SmartKey or KEYLESS-GO.  
Indicator lamp ① flashes. The alarm system is armed after approximately 15 seconds.
- ▶ **To switch off:** unlock the vehicle with the SmartKey or KEYLESS-GO.

A visual and audible alarm is triggered if the alarm system is armed and you open:

- a door
  - the vehicle with the mechanical key
  - the trunk lid
  - the hood
  - the glove compartment
  - the stowage space under the armrest
  - a stowage compartment in the rear passenger compartment
- ▶ **To stop the alarm with the SmartKey:**  
press the  or  button on the SmartKey.  
The alarm is stopped.
- or
- ▶ Insert the SmartKey into the ignition lock.  
The alarm is stopped.
- ▶ **To stop the alarm using KEYLESS-GO:**  
grasp the outside door handle. The SmartKey must be outside the vehicle.  
The alarm is stopped.

or

- ▶ Press the Start/Stop button on the dashboard. The SmartKey must be inside the vehicle.  
The alarm is stopped.

The alarm is not stopped, even if you close the open door that triggered it, for example.

If the alarm stays on for more than 30 seconds, the Mercedes me connect emergency call system automatically sends a message to the Customer Center.

This is done either by text message or data connection. The emergency call system sends the message or data provided that:

- you have subscribed to Mercedes me connect
- the Mercedes me connect service has been activated properly
- the necessary mobile phone network is available

## SmartKey

### Important safety notes

#### WARNING

If children are left unsupervised in the vehicle, they could:

- operate the vehicle's equipment
- Additionally, children could set the vehicle in motion if, for example, they:
- release the parking brake
  - shift the automatic transmission out of park position **P**
  - start the engine

There is a risk of an accident and injury.

Never leave children or animals unattended in the vehicle.

When leaving the vehicle, always take the SmartKey with you and lock the vehicle. This also applies for the Digital Vehicle Key if the "Digital Vehicle Key" function is activated via Mercedes me connect.

#### WARNING

If you attach heavy or large objects to the SmartKey, the SmartKey could be unintentionally turned in the ignition lock. This could cause the engine to be switched off. There is a risk of an accident.

Do not attach any heavy or large objects to the SmartKey. Remove any bulky key rings before inserting the SmartKey into the ignition lock.

- ❗ Keep the SmartKey away from strong magnetic fields. Otherwise, the remote control function could be affected.

Strong magnetic fields can occur in the vicinity of powerful electrical installations.



Do not keep the SmartKey:

- with electronic devices, e.g. a mobile phone or another SmartKey
  - with metallic objects, e.g. coins or metal foil
  - inside metallic objects, e.g. a metal case
- This can affect the functionality of the SmartKey.

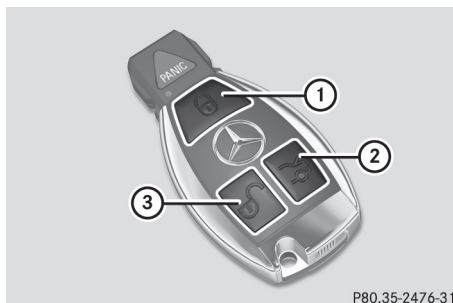
## SmartKey functions



P80.35-2476-31

- ①  Locks the vehicle
- ②  Opens/closes the trunk lid
- ③  Unlocks the vehicle

► **To unlock centrally:** press the  button.

If you do not open the vehicle within approximately 40 seconds of unlocking:

- the vehicle is locked again.
- anti-theft protection is reactivated

► **To lock centrally:** press the  button.

The SmartKey centrally locks/unlocks:

- the doors
- the trunk lid
- the glove compartment
- the stowage compartment under the armrest
- the stowage compartment in the rear
- the fuel filler flap

The turn signals flash once when unlocking and three times when locking.

You can also set an audible signal to confirm that the vehicle has been locked. The audible signal can be activated and deactivated using the on-board computer (> page 201).

When it is dark, the surround lighting also comes on if it is activated in the on-board computer (> page 200).

## KEYLESS-GO

### General notes

Bear in mind that the engine can be started by any of the vehicle occupants if there is a KEYLESS-GO key in the vehicle (> page 128).

## Locking/unlocking centrally

You can start, lock or unlock the vehicle using KEYLESS-GO. To do this, you only need carry the SmartKey with you. You can combine the functions of KEYLESS-GO with those of a conventional SmartKey. Unlock the vehicle by using KEYLESS-GO, for instance, and lock it using the  button on the SmartKey.

The driver's door and the door at which the handle is used, must both be closed. The SmartKey must be outside the vehicle. When locking or unlocking with KEYLESS-GO, the distance between the key and the corresponding door handle must not be greater than 3 ft (1 m).

A check which periodically establishes a radio connection between the vehicle and the SmartKey determines whether a valid SmartKey is in the vehicle. This occurs, for example:

- when starting the engine
- while driving
- when using HANDS-FREE ACCESS
- when the external door handles are touched

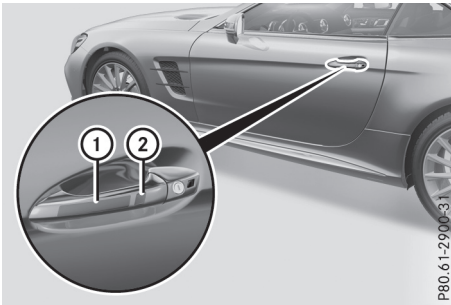

- ▶ **To unlock the vehicle:** touch the inner surface of the door handle.
- ▶ **To lock the vehicle:** touch sensor surface ① or ②.  
Make sure that you do not touch the inner surface of the door handle.
- ▶ **Convenience closing feature:** touch recessed sensor surface ② for an extended period.  
Further information on the convenience closing feature (▷ page 89).

## Deactivating and activating



If you do not intend to use a SmartKey for an extended period of time, you can deactivate the KEYLESS-GO function of the key. The SmartKey will then use very little power, thereby conserving battery power. For the purposes of activation/deactivation, the vehicle must not be nearby.

- ▶ **To deactivate:** press the  button on the SmartKey twice in rapid succession. The battery check lamp (▷ page 77) of the SmartKey flashes twice briefly and lights up once, then KEYLESS-GO is deactivated.
  - ▶ **To activate:** press any button on the SmartKey.
- or
- ▶ Insert the SmartKey into the ignition lock. KEYLESS-GO and all of its associated features are available again.

## Changing the settings of the locking system



You can change the settings of the locking system. This means only the driver's door, the lockable stowage compartments in the vehicle interior and the fuel filler flap are unlocked when the vehicle is unlocked. This is useful if you frequently travel alone.

- ▶ **To change the setting:** press and hold down the  and  buttons simultaneously for about six seconds until the battery indicator lamp (▷ page 77) flashes twice.



If the setting of the locking system is changed within the signal range of the vehicle, pressing the  or  button:

- locks or
- unlocks the vehicle

The SmartKey now functions as follows:

- ▶ **To unlock:** press the  button once.
- ▶ **To unlock centrally:** press the  button twice.
- ▶ **To lock centrally:** press the  button.

The KEYLESS-GO function is changed as follows:

- ▶ **To unlock the driver's door:** touch the inner surface of the door handle on the driver's door.
- ▶ **To unlock centrally:** touch the inner surface of the driver or front-passenger door handle.
- ▶ **To lock centrally:** touch the outer sensor surface on one of the door handles.
- ▶ **To restore the factory settings:** press and hold down the  and  buttons simultaneously for approximately six seconds until the battery check lamp (▷ page 77) flashes twice.

## Mechanical key

### General notes

If the vehicle can no longer be locked or unlocked with the SmartKey or with KEYLESS-GO, use the mechanical key.

If you use the mechanical key to unlock and open the driver's door or the trunk lid, the anti-theft alarm system will be triggered. Switch off the alarm (▷ page 72).

### Removing the mechanical key

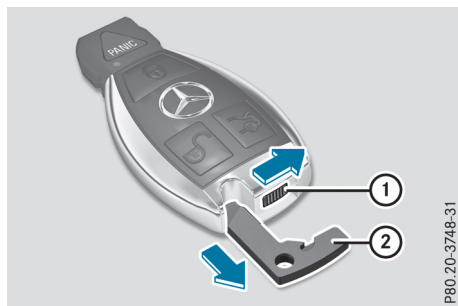

P80.20-3748-31

- ▶ Push release catch ① in the direction of the arrow and at the same time remove mechanical key ② from the SmartKey.

For further information about:

- unlocking the driver's door (▷ page 81)
- unlocking the trunk (▷ page 86)
- locking the vehicle (▷ page 81)

## Inserting the mechanical key

- ▶ Push mechanical key ② completely into the SmartKey until it engages and release catch ① is back in its basic position.

## SmartKey battery

### Important safety notes

#### WARNING

Batteries contain toxic and corrosive substances. If batteries are swallowed, it can result in severe health problems. There is a risk of fatal injury.

Keep batteries out of the reach of children. If a battery is swallowed, seek medical attention immediately.

#### Environmental note



Batteries contain pollutants. It is illegal to dispose of them with the household rubbish. They must be collected separately and disposed of in an environmentally responsible recycling system.





Dispose of batteries in an environmentally responsible manner. Take discharged batteries to a qualified specialist workshop or to a collection point for used batteries.

The SmartKey batteries contain perchlorate material, which may require special handling and regard for the environment. National guidelines must be observed during disposal. In California, see [www.dtsc.ca.gov/HazardousWaste/Perchlorate/index.cfm](http://www.dtsc.ca.gov/HazardousWaste/Perchlorate/index.cfm). Mercedes-Benz recommends that you have the batteries replaced at a qualified specialist workshop.



## Checking the battery



P80.35-2473-31

- ▶ Press the  or  button. The battery is working properly if battery check lamp ① lights up briefly. The battery is discharged if battery check lamp ① does not light up briefly.

- ▶ Change the battery (▷ page 77).

If the SmartKey battery is checked within the signal reception range of the vehicle, pressing the  or  button:

- locks or
- unlocks the vehicle

**i** You can get a battery at any qualified specialist workshop.

## Replacing the battery

You require a CR 2025 3 V cell battery.

- ▶ Take the mechanical key out of the SmartKey (▷ page 76).

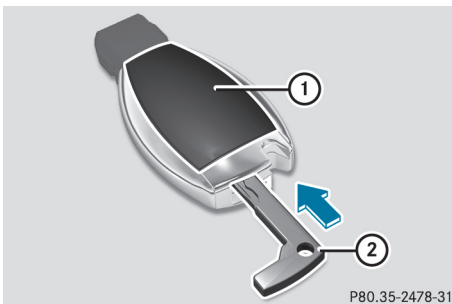

P80.35-2478-31

- ▶ Press mechanical key ② into the SmartKey opening in the direction of the arrow until battery compartment cover ① opens. Do not hold battery compartment cover ① closed while doing so.
- ▶ Remove battery compartment cover ①.

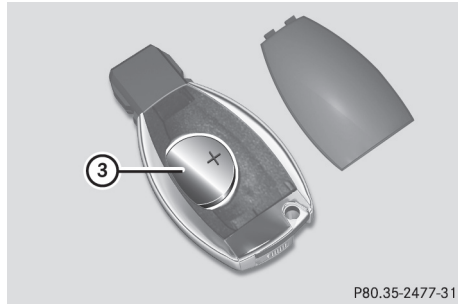

P80.35-2477-31

- ▶ Repeatedly tap the SmartKey against your palm until battery ③ falls out.
- ▶ Insert the new battery with the positive terminal facing upwards. Use a lint-free cloth to do so.
- ▶ Make sure that the surface of the battery is free of lint, grease and other contaminants.
- ▶ Insert the front tabs of battery compartment cover ① into the housing and then press to close it.
- ▶ Insert mechanical key ② into the SmartKey (▷ page 76).
- ▶ Check the function of all SmartKey buttons on the vehicle.

## Problems with the SmartKey

Problem	Possible causes/consequences and ► Solutions
You can no longer lock or unlock the vehicle using the SmartKey.	The SmartKey battery is discharged or nearly discharged. ► Check the SmartKey battery (▷ page 77) and replace it if necessary (▷ page 77). If this does not work: ► Unlock (▷ page 81) or lock (▷ page 81) the vehicle using the mechanical key.
	There is interference from a powerful source of radio waves. ► Unlock (▷ page 81) or lock (▷ page 81) the vehicle using the mechanical key.
	The SmartKey is faulty. ► Unlock (▷ page 81) or lock (▷ page 81) the vehicle using the mechanical key. ► Have the SmartKey checked at a qualified specialist workshop.
You can no longer lock or unlock the vehicle using KEYLESS-GO.	KEYLESS-GO was deactivated. ► Reactivate KEYLESS-GO (▷ page 74).
	The SmartKey battery is discharged or nearly discharged. ► Check the SmartKey battery (▷ page 77) and replace it if necessary (▷ page 77). If this does not work: ► Unlock (▷ page 81) or lock (▷ page 81) the vehicle using the mechanical key.
	There is interference from a powerful source of radio waves. ► Unlock (▷ page 81) or lock (▷ page 81) the vehicle using the mechanical key.
	KEYLESS-GO is malfunctioning. ► Lock/unlock the vehicle using the remote control function of the SmartKey. ► Have the vehicle and SmartKey checked at a qualified specialist workshop. If the vehicle can also not be locked/unlocked using the remote control function: ► Unlock (▷ page 81) or lock (▷ page 81) the vehicle using the mechanical key. ► Have the vehicle and SmartKey checked at a qualified specialist workshop.



Problem	Possible causes/consequences and ► Solutions
The engine cannot be started using the SmartKey.	<p>The on-board voltage is too low.</p> <ul style="list-style-type: none"> <li>► Switch off non-essential consumers, e.g. seat heating or interior lighting, and try to start the engine again.</li> </ul> <p>If this does not work:</p> <ul style="list-style-type: none"> <li>► Check the starter battery and charge it if necessary (▷ page 284).</li> </ul> <p>or</p> <ul style="list-style-type: none"> <li>► Jump-start the vehicle (▷ page 285).</li> </ul> <p>or</p> <ul style="list-style-type: none"> <li>► Consult a qualified specialist workshop.</li> </ul>
The engine cannot be started using KEYLESS-GO. The SmartKey is in the vehicle.	<p>The vehicle is locked.</p> <ul style="list-style-type: none"> <li>► Unlock the vehicle and try to start the vehicle again.</li> </ul> <p>The SmartKey battery is discharged or nearly discharged.</p> <ul style="list-style-type: none"> <li>► Check the SmartKey battery (▷ page 77) and replace it if necessary (▷ page 77).</li> </ul> <p>If this does not work:</p> <ul style="list-style-type: none"> <li>► Start your vehicle with the SmartKey in the ignition lock.</li> </ul> <p>There is interference from a powerful source of radio waves.</p> <ul style="list-style-type: none"> <li>► Start your vehicle with the SmartKey in the ignition lock.</li> </ul>
You have lost a SmartKey.	<ul style="list-style-type: none"> <li>► Have the SmartKey deactivated at a qualified specialist workshop.</li> <li>► Report the loss immediately to the vehicle insurers.</li> <li>► If necessary, have the locks changed as well.</li> </ul>
You have lost the mechanical key.	<ul style="list-style-type: none"> <li>► Report the loss immediately to the vehicle insurers.</li> <li>► If necessary, have the locks changed as well.</li> </ul>
The side windows cannot be opened or closed using the convenience opening/closing feature.	<p>The SmartKey battery is discharged or nearly discharged.</p> <ul style="list-style-type: none"> <li>► Check the SmartKey battery (▷ page 77) and replace it if necessary (▷ page 77).</li> </ul>

## Doors

### Important safety notes

#### WARNING

If children are left unsupervised in the vehicle, they could:

- operate the vehicle's equipment

Additionally, children could set the vehicle in motion if, for example, they:

- release the parking brake
- shift the automatic transmission out of park position **P**
- start the engine

There is a risk of an accident and injury.

Never leave children or animals unattended in the vehicle.

When leaving the vehicle, always take the SmartKey with you and lock the vehicle. This also applies for the Digital Vehicle Key if the "Digital Vehicle Key" function is activated via Mercedes me connect.

### Unlocking and opening doors from the inside

**!** The side windows will not open/close if the battery is discharged or if the side windows have iced up. It will then not be possible to close the door. Do not attempt to force the door closed. You could otherwise damage the door or the side window.

You can open a door from inside the vehicle even if it has been locked.

If the vehicle has previously been locked from the outside, opening a door from the inside will trigger the anti-theft alarm system. Switch off the alarm (▷ page 72).

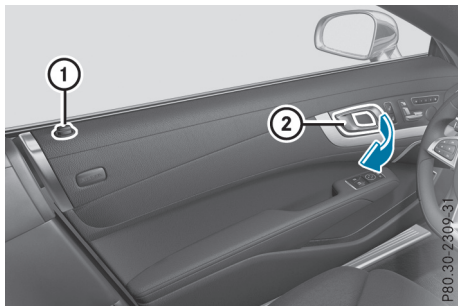

- ▶ Pull door handle (2).  
If the door is locked, locking knob (1) pops up. The door is unlocked and can be opened.

When a door is opened, the side window on that side opens slightly. When the door is closed, the side window closes again.

### Centrally locking and unlocking the vehicle from the inside

You can centrally lock or unlock the vehicle from the inside. For example, you can unlock

the front-passenger door from the inside or lock the vehicle before you pull away.



- ▶ **To unlock:** press button (1).
- ▶ **To lock:** press button (2).  
If the front-passenger door is closed, the vehicle locks.

The central locking button does not lock or unlock the fuel filler flap or the stowage compartments, such as the glove box.

You cannot unlock the vehicle centrally from the inside if the vehicle has been locked with the SmartKey or KEYLESS-GO.

You can open a door from inside the vehicle even if it has been locked.

If a locked door is opened from the inside, the previous unlock status of the vehicle will be taken into consideration if:

- the vehicle was locked using the locking button for the central locking, or
- if the vehicle was locked automatically

The vehicle will be fully unlocked if it had previously been fully unlocked. If only the driver's door had been previously unlocked, only the door which has been opened from the inside is unlocked.

### Automatic locking feature



- ▶ **To deactivate:** press and hold button ① for about five seconds until a tone sounds.
- ▶ **To activate:** press and hold button ② for about five seconds until a tone sounds.

If you press one of the two buttons and do not hear a tone, the relevant setting has already been selected.

The vehicle is locked automatically when the ignition is switched on and the wheels are turning.

You could therefore lock yourself out if:

- the vehicle is being pushed.
- the vehicle is being towed.
- the vehicle is on a roller dynamometer.

You can also switch the automatic locking function on and off using the on-board computer (▷ page 201).

### Power closing

Power closing pulls the doors and trunk lid into their locks automatically even if they are only partly closed.

- ▶ **Power closing feature (doors):** push the door past the first detent position into the lock.  
Power closing will pull the door fully closed.
- ▶ **To power close the trunk lid:** lightly push the trunk lid closed.  
The power closing function pulls the trunk lid closed.

### Unlocking/locking the driver's door using the mechanical key

- ❗ If you want to centrally lock the vehicle using the mechanical key, begin by pressing the locking button for the interior locking mechanism while the driver's door is open. Then lock the driver's door using the mechanical key.

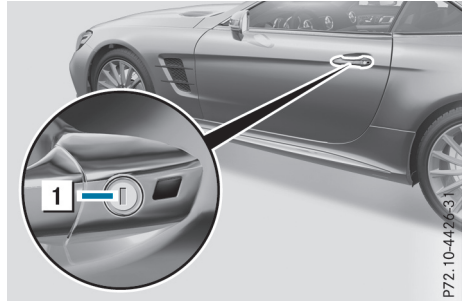

- ▶ **To unlock:** turn the mechanical key counter-clockwise as far as it will go to position 1.
- ▶ **To lock:** turn the mechanical key clockwise as far as it will go to position 1.

If you use the mechanical key to unlock and open the driver's door, the anti-theft alarm system will be triggered. Switch off the alarm (▷ page 72).

### Trunk

#### Important safety notes

#### WARNING

If objects, luggage or loads are not secured or not secured sufficiently, they could slip, tip over or be flung around and thereby hit vehicle occupants. There is a risk of injury, particularly in the event of sudden braking or a sudden change in direction.

Always store objects so that they cannot be flung around. Secure objects, luggage or loads against slipping or tipping before the journey.

- ❗ The trunk lid swings upwards when opened. Therefore, make sure that there is sufficient clearance above the trunk lid.

**!** Only close the trunk once the roof is lowered completely. Otherwise, you could damage the roof.

If you close the trunk lid before the roof is lowered completely, the loading aid switch lights up and a warning tone sounds.

The opening dimensions of the trunk lid can be found in the "Vehicle data" section (▷ page 326).

With the roof open, you can use the loading aid to raise the folded roof in the trunk to make loading easier (▷ page 251). The trunk partition opens automatically.

You can unlock the trunk lid if the vehicle is stationary and the roof is completely open or closed.

Do not leave the SmartKey in the trunk. You could otherwise lock yourself out.

The trunk lid can be:

- opened/closed from outside
- opened and closed automatically from outside (vehicles with trunk lid remote closing feature)
- opened and closed automatically from inside (vehicles with trunk lid remote closing feature)
- opened, closed or stopped during operation without the use of your hands (vehicles with KEYLESS-GO and HANDS-FREE ACCESS)
- locked separately
- opened with the emergency release button
- unlocked with the mechanical key

You should preferably place luggage or loads in the trunk.

### Trunk lid reversing feature

The trunk lid is equipped with an automatic reversing feature. It reacts if a solid object obstructs or restricts the trunk lid during the closing procedure. The trunk lid opens again automatically. The automatic reversing function is only an aid and is not a substitute for your attentiveness to the trunk lid while it is closing.

### WARNING

The reversing feature does not respond:

- to soft, light and thin objects, e.g. fingers
- over the last 1/3 in (8 mm) of the closing movement

The reversing feature cannot prevent someone being trapped in these situations in particular. There is a risk of injury.

Make sure that no body parts are in close proximity during the closing procedure.

If somebody becomes trapped:

- press the  button on the SmartKey, or
- pull or press the remote operating switch on the driver's door or
- press the closing or locking button on the trunk lid, or
- pull on the trunk lid handle

### Opening/closing from outside

#### Opening

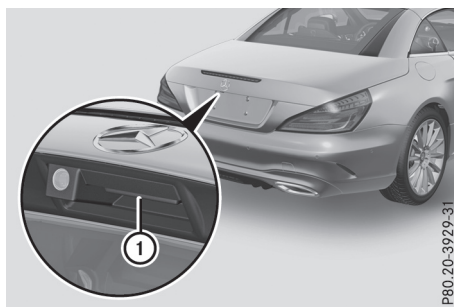

- ▶ Press the  button on the SmartKey.
- ▶ Pull handle ①.
- ▶ Lift the trunk lid.

If the trunk partition was closed, it opens automatically and remains open.

With the roof open, you can use the loading aid to raise the folded roof in the trunk to make loading easier (▷ page 251). The trunk partition opens automatically.

## Closing

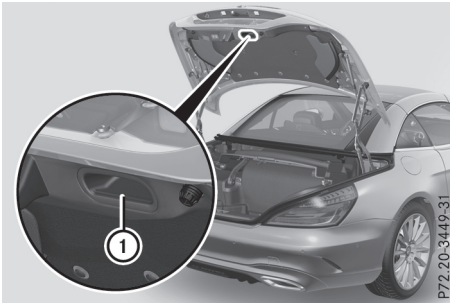

- ▶ Pull the trunk lid down using recess ①.
- ▶ Lock the vehicle if necessary with the button on the SmartKey or with KEYLESS-GO.

It does not lock if a SmartKey with KEYLESS-GO is detected in the trunk.

## Opening/closing automatically from the outside

### Important safety notes

#### WARNING

Parts of the body could become trapped during automatic closing of the trunk lid. Moreover, people, e.g. children, may be standing in the closing area or may enter the closing area during the closing process. There is a risk of injury.

Make sure that nobody is in the vicinity of the closing area during the closing process. Use one of the following options to stop the closing process:

- press the button on the SmartKey.
- pull or press the remote operating switch on the driver's door.
- press the closing or locking button on the trunk lid.
- pull the trunk lid handle

**!** The trunk lid swings upwards when opened. Therefore, make sure that there is sufficient clearance above the trunk lid.

The opening dimensions of the trunk lid can be found in the "Vehicle data" section (▶ page 326).

## Opening automatically

You can automatically open the trunk lid using the trunk lid handle.

- ▶ If the trunk lid is unlocked, pull the trunk lid handle and let it go again immediately. When the roof is open, the trunk partition closes automatically. If the trunk partition was closed, it opens automatically and remains open.

**Vehicles with the trunk lid remote closing feature:** the trunk lid can also be opened automatically with the SmartKey.

- ▶ Press and hold the button on the SmartKey until the trunk lid opens.

## Closing automatically

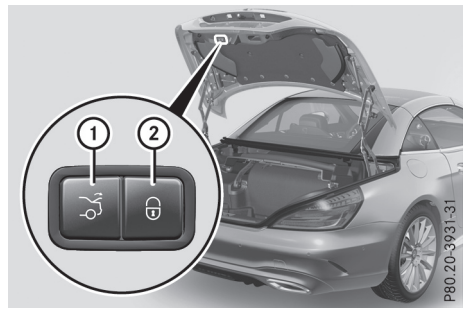

- ▶ Press and release closing button ① on the trunk lid.

**Vehicles with trunk lid remote closing feature and KEYLESS-GO:**

- ▶ If the driver's door is closed, you can simultaneously close the trunk lid and lock the vehicle. The KEYLESS-GO key must be in the rear detection range of the vehicle.
- ▶ Press locking button ② in the trunk lid. The trunk partition, the loading aid and the trunk lid are closed.

If a KEYLESS-GO key is detected outside the vehicle, the trunk lid closes and the vehicle locks.

If a KEYLESS-GO key is detected in the trunk, the trunk lid opens again after it is closed. It does not lock.

## HANDS-FREE ACCESS

### General notes

With KEYLESS-GO and HANDS-FREE ACCESS, you can open or close the trunk lid or stop the procedure without using your hands. This is useful if you have your hands full. To do this, make a kicking movement under the bumper with your foot.

Observe the following points:

- Carry your KEYLESS-GO key about your person. The SmartKey must be at the rear of the vehicle in the detection range of KEYLESS-GO.
- When making the kicking movement, make sure that you are standing firmly on the ground and that there is sufficient clearance to the rear of the vehicle. You could otherwise lose your balance, for example on ice.

### Important safety notes

#### WARNING

The vehicle exhaust system can become very hot. If you use HANDS-FREE ACCESS, you could burn yourself by touching the exhaust system. There is a risk of injury. Always ensure that you make the kicking movement only within the detection range of the sensors.

**!** If the SmartKey is within the rear detection range of KEYLESS-GO, the following situations, for example, could lead to the unintentional opening of the trunk lid:

- when using an automatic car wash
- when using a power washer

Make sure that the SmartKey is at least 10 ft (3 m) away from the vehicle.

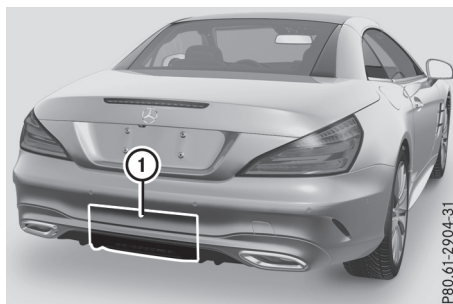

P80.61-2904-31

- Always ensure that you make the kicking movement only within the detection range of sensors ①.
- Stand at least 12 in (30 cm) away from the rear area while doing so.
- Do not come into contact with the bumper while making the kicking movement. Otherwise, the sensors may not function correctly.
- HANDS-FREE ACCESS does not function during engine start.
- Dirt caused by road salt and snow build-up around sensors ① may restrict functionality.
- Using the HANDS-FREE ACCESS with a prosthetic leg may restrict functionality.
- If a KEYLESS-GO key is at the rear of the vehicle in the detection range of KEYLESS-GO, HANDS-FREE ACCESS could be triggered. The trunk lid could thus be opened or closed unintentionally, for example, if you:
  - sit on the edge of the trunk.
  - set something down or lift something up behind the vehicle.
  - polish the rear of the vehicle.

Do not carry the KEYLESS-GO key about your person in these situations or in situations similar to these. This will prevent the unintentional opening/closing of the trunk lid.



## Operation

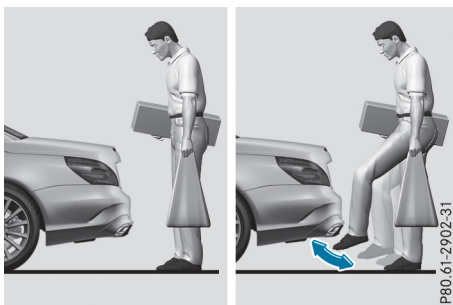

- ▶ **To open/close:** kick your foot into sensor detection zone ① below the bumper. A warning tone will sound while the trunk lid is opening or closing.
- ▶ **If the trunk lid does not open after several attempts:** wait at least ten seconds then move your leg under the bumper once again.

If you hold your foot under the bumper for too long, the trunk lid does not open or close. Repeat the leg movement more quickly if this occurs.

To stop the opening or closing procedure, you have the following options:

- kick with your foot into sensor detection range ① under the bumper
  - Pull the handle on the outside of the trunk lid.
  - Press the closing button on the trunk lid.
  - Pull or press the remote operating switch on the driver's door.
  - Press the  button on the SmartKey.
- If the trunk lid closing procedure has been stopped:

- Move your foot under the bumper again and the trunk lid will open.

If the trunk lid opening procedure has been stopped:

- Move your foot under the bumper again and the trunk lid will close.

## Opening/closing automatically from inside

### Important safety notes

#### WARNING

Parts of the body could become trapped during automatic closing of the trunk lid. In addition, people may be standing in the closing area or may enter the closing area, e.g. children, during the closing procedure. There is a risk of injury.

Make sure that nobody is in the vicinity of the closing area during the closing process. Release the remote operating switch immediately if somebody becomes trapped. To reopen the trunk lid, pull on the remote operating switch.

#### WARNING

The trunk lid can be automatically opened or closed even if the SmartKey is not in the vehicle. If children are left unsupervised in the vehicle, they could activate the functions. There is a risk of injury.

When leaving the vehicle, always take the SmartKey with you and lock the vehicle. Never leave children unsupervised in the vehicle.

- ❗ The trunk lid swings upwards when opened. Therefore, make sure that there is sufficient clearance above the trunk lid.

The opening dimensions of the trunk lid can be found in the "Vehicle data" section (> page 326).



## Opening and closing



- ▶ **To open:** pull remote operating switch ① for the trunk lid until the trunk lid opens. If the trunk partition was closed, it opens automatically and remains open.
- ▶ **To close:** press remote operating switch ① for the trunk lid until the trunk lid is closed. When the roof is open, the trunk partition closes automatically.

You can open and close the trunk lid from the driver's seat when the vehicle is stationary and unlocked.

## Locking the trunk separately

You can lock the trunk separately. If you then unlock the vehicle centrally, the trunk remains locked and cannot be opened.

- ▶ Close the trunk lid.
- ▶ Take the mechanical key out of the Smart-Key (▷ page 76).

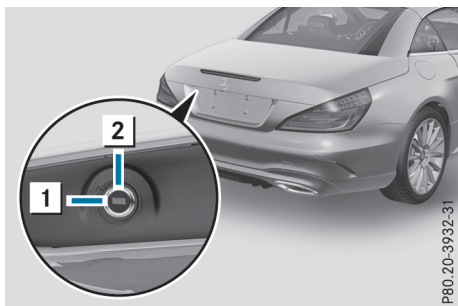

- ▶ Insert the mechanical key into the trunk lid lock as far as it will go.
- ▶ Turn the mechanical key clockwise from position ① to position ②.

- ▶ Remove the mechanical key.
- ▶ Insert the mechanical key into the Smart-Key.

## Unlocking the trunk (mechanical key)

- The trunk lid swings upwards when opened. Therefore, make sure that there is sufficient clearance above the trunk lid.

If the trunk cannot be unlocked with the SmartKey or KEYLESS-GO, use the mechanical key.

If you use the mechanical key to unlock and open the trunk lid, the anti-theft alarm system will be triggered. Switch off the alarm (▷ page 72).

- ▶ Take the mechanical key out of the Smart-Key (▷ page 76).
- ▶ Insert the mechanical key into the trunk lid lock as far as it will go.

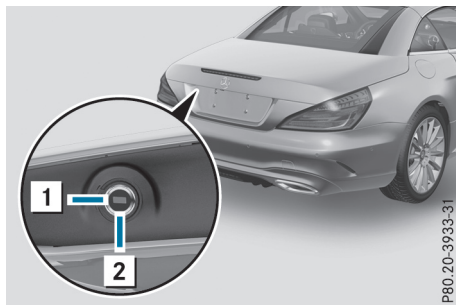

- ▶ Turn the mechanical key from position ① counter-clockwise as far as it will go to position ②. Simultaneously pull the trunk lid handle. The trunk is unlocked.
- ▶ Turn the mechanical key back to position ① and remove it.
- ▶ Insert the mechanical key into the Smart-Key.

## Emergency release for the trunk

You can unlock the trunk lid from the inside with the emergency release button.

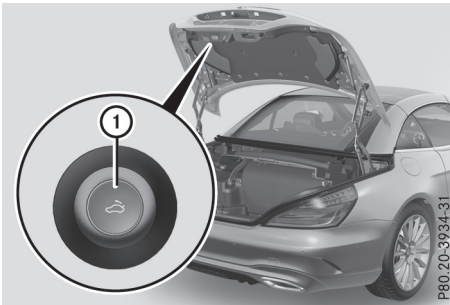

PE0.Z0.3934-31

- ▶ Press emergency release button ① briefly. The trunk lid unlocks and opens.

The trunk lid can be unlocked and opened with the trunk lid emergency release when the vehicle is stationary or while driving.

The trunk lid emergency release does not unlock the trunk lid if the battery is disconnected or discharged.

Trunk lid emergency release light:

- Emergency release button ① flashes for 30 minutes after the trunk lid is opened
- Emergency release button ① flashes for 60 minutes after the trunk lid is closed

## Side windows

### Important safety notes

#### WARNING

While opening the side windows, body parts could become trapped between the side window and the door frame as the side window moves. There is a risk of injury.

Make sure that nobody touches the side window during the opening procedure. If somebody becomes trapped, release the switch or pull the switch to close the side window again.

#### WARNING

While closing the side windows, body parts in the closing area could become trapped. There is a risk of injury.

When closing make sure that no parts of the body are in the closing area. If somebody becomes trapped, release the switch or

press the switch to open the side window again.

#### WARNING

If children operate the side windows they could become trapped, particularly if they are left unsupervised. There is a risk of injury.

When leaving the vehicle, always take the SmartKey with you and lock the vehicle. Never leave children unsupervised in the vehicle.

### Side window reversing feature

The front side windows are equipped with an automatic reversing feature. If a solid object blocks or restricts the upward movement of one of the front side windows during the closing process, the side window opens again automatically. During the manual closing process, the side window only opens again automatically after the corresponding switch is released. However, the automatic reversing feature is only an aid and does not relieve you of the responsibility of paying attention when closing a side window.

#### WARNING

The reversing feature does not respond:

- to soft, light and thin objects, e.g. fingers
- over the last 1/6 in (4 mm) of the closing movement
- while adjusting
- when closing the side window again manually immediately after automatic reversing

This means that the reversing feature cannot prevent someone being trapped in these situations. There is a risk of injury.

Make sure that no body parts are in close proximity during the closing procedure. If someone becomes trapped, press the switch to open the side window again.

## Opening and closing the side windows

### Opening and closing the side windows in the front

The switches for the side windows are located on the driver's door. There is also a switch for the front-passenger side window on the front-passenger door.

The switches on the driver's door take precedence.

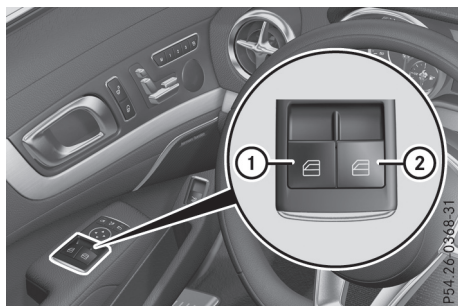

- ① Left
- ② Right

- ▶ Turn the SmartKey to position **1** or **2** in the ignition lock.
- ▶ **To open manually:** press and hold the corresponding switch.
- ▶ **To open fully:** press the switch beyond the pressure point and release it. Automatic operation is started.
- ▶ **To close manually:** pull the corresponding switch and hold it.
- ▶ **To close fully:** pull the switch beyond the pressure point and release it. Automatic operation is started.
- ▶ **To interrupt automatic operation:** press or pull the corresponding switch again.

You can continue to operate the side windows after you switch off the engine. This function is available for up to five minutes or until the driver's or front-passenger door is opened.

### Opening/closing the rear side windows

- ▶ **To open:** open the front side window on the corresponding side (▷ page 88).
- ▶ Press the corresponding switch again and release. The corresponding rear side window opens fully.
- ▶ **To stop the rear side windows:** briefly pull the corresponding switch up and release.
- ▶ **To close:** close the front side window on the corresponding side (▷ page 88).
- ▶ Pull the respective switch and hold it. The corresponding rear side window will continue to close until you release the switch.

### Opening and closing all side windows

#### Using the switch on the center console

#### **WARNING**

While opening the side windows, body parts in the closing area could become trapped. There is a risk of injury.

Make sure that no body parts are in close proximity during the closing procedure. If somebody becomes trapped, release the switch or press the switch down to open the side window again.

You can use the switch on the center console to close all side windows simultaneously.

- ▶ Open the cover in the lower center console. The switch for all side windows is under the cover.

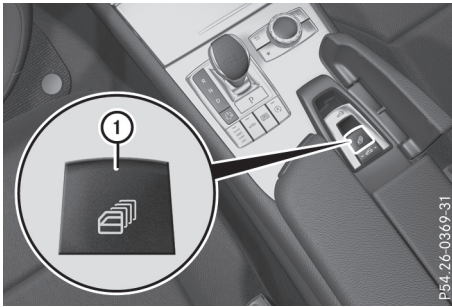

P84.26-0369-31

- ▶ **To open all side windows:** press button ① to the point of resistance.
- ▶ **To open all side windows fully:** press switch ① beyond the point of resistance.
- ▶ **To close all side windows:** pull switch ①. All side windows begin the closing procedure simultaneously. The rear side windows close after the front side windows.

If, after opening the windows, you close one side window using the switch in the door control panel:

- the front side window closes first and
- then the corresponding rear side window closes.

### Convenience closing with KEYLESS-GO

#### WARNING

When using the convenience closing feature, parts of the body could be trapped in the closing area when a side window is being closed. There is a risk of injury.

Observe the complete closing procedure when the convenience closing feature is operating. Make sure that no body parts are in close proximity during the closing procedure.

Proceed as follows if someone is trapped:

- ▶ Release the recessed sensor surface on the door handle.
- ▶ Immediately pull and hold the door handle and keep the door handle pulled. The side windows open.

With KEYLESS-GO you can close all side windows simultaneously. The KEYLESS-GO key must be outside the vehicle. All the doors must be closed.

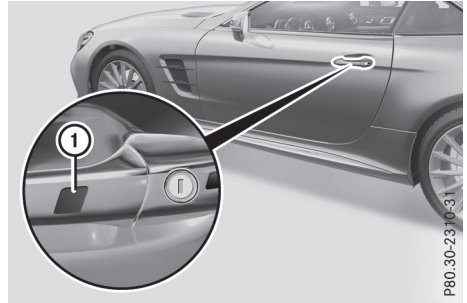

P80.30-2310-31

- ▶ Touch recessed sensor surface ① on the door handle until the side windows are fully closed.
- ▶ **i** Make sure you only touch recessed sensor surface ①.
- ▶ **To interrupt convenience closing:** release recessed sensor surface ① on the door handle.

### Resetting the side windows

If a side window can no longer be closed fully, you must reset it.

- ▶ Close all the doors.
- ▶ Turn the SmartKey to position 1 or 2 in the ignition lock.
- ▶ Pull the corresponding switch on the door control panel until the side window is completely closed (▷ page 88).
- ▶ Hold the switch for an additional second.

If the side window opens again slightly:

- ▶ Immediately pull the corresponding switch on the door control panel until the side window is completely closed (▷ page 88).
- ▶ Hold the switch for an additional second. If the respective side window remains closed after the button is released, then it has been set correctly. If this is not the case, repeat the steps above.

## Problems with the side windows

### WARNING

If you close a side window again immediately after it has been blocked or reset, the side window closes with increased or maximum force. The reversing feature is then not active. Parts of the body could be trapped in the closing area in the process. This poses an increased risk of injury or even fatal injury.

Make sure that no parts of the body are in the closing area. To stop the closing process, release the switch or push the switch again to reopen the side window.

Problem	Possible causes/consequences and ► Solutions
A side window cannot be closed because it is blocked by objects, e.g. leaves in the window guide.	<ul style="list-style-type: none"> <li>► Remove the objects.</li> <li>► Close the side window.</li> </ul>
A side window cannot be closed and you cannot see the cause.	<p>If a side window is obstructed during closing and reopens again slightly:</p> <ul style="list-style-type: none"> <li>► Immediately after the window blocks, pull the corresponding switch again until the side window has closed. The side window is closed with increased force.</li> </ul> <p>If a side window is obstructed again during closing and reopens again slightly:</p> <ul style="list-style-type: none"> <li>► Immediately after the window blocks, pull the corresponding switch again until the side window has closed. The side window is closed without the automatic reversing feature.</li> </ul>
The side windows cannot be opened or closed using the convenience opening/closing feature.	<p>The SmartKey battery is discharged or nearly discharged.</p> <ul style="list-style-type: none"> <li>► Check the SmartKey battery (► page 77) and replace it if necessary (► page 77).</li> </ul>

## Roof

### Important safety notes

### WARNING

If you do not fully open/close the soft top, the soft-top hydraulics depressurize after a short time. This causes the soft top to lower unexpectedly and may cause you or others to be trapped. There is a risk of injury.

Always open or close the soft top completely.

### WARNING

Closing the roof manually is a complicated and technically demanding procedure, which requires a lot of strength. You or others can become trapped. There is a risk of injury.

Only have the soft top closed manually at a qualified specialist workshop.

 Never sit on the rear compartment trim or stow heavy objects there. You will otherwise damage the roof and rear compartment trim of the vehicle.

**!** Do not forget that the weather can change abruptly. Make certain that the roof is closed when you leave the vehicle. The vehicle electronics can be damaged if water enters the vehicle interior.

**!** When opening and closing the roof, make sure that:

- there is sufficient clearance, as the roof swings upwards.
- there is sufficient clearance behind the vehicle, as the trunk lid swings backwards beyond the bumper.
- the trunk is only loaded to below the trunk partition.
- the trunk partition is not pushed up by the load.
- the trunk partition is closed.
- the trunk lid is closed.
- the outside temperature is above 5 °F (-15 °C).

You could otherwise damage the roof, trunk and other parts of the vehicle.

The vehicle dimensions for opening/closing the roof can be found in the "Vehicle data" section (▷ page 326).

Make sure that the roof and rear window are clean and dry before opening the roof. Otherwise, water or dirt could enter the vehicle interior or trunk.

## Opening and closing using the roof switch

### Important safety notes

#### WARNING

When opening or closing the roof, body parts could be trapped by, for example, the roof mechanism, trunk lid or side windows. There is a risk of injury.

When raising or lowering the roof, make sure that no body parts are in the vicinity of moving components. If someone becomes trapped, release the button.

For safety reasons, you can only open or close the roof when the vehicle is stationary.

**!** Operating the roof while pulling away:

- Observe the following traffic carefully.
- Do not drive faster than 25 mph (40 km/h).
- Avoid abrupt braking and swerving maneuvers.

Do not operate the roof when cornering, driving on uneven surfaces or during strong winds. The vehicle may otherwise be damaged.

**i** If the traffic conditions mean that you have to drive off while opening/closing the roof, the procedure which was started while stationary can be continued at speeds of up to approximately 25 mph (40 km/h).

### Opening and closing

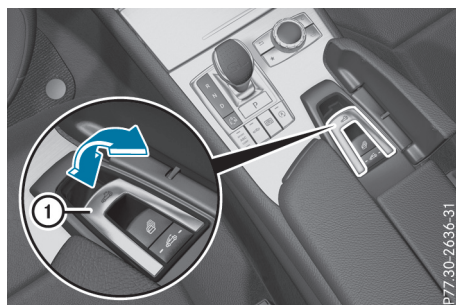

- ▶ Close the trunk lid (▷ page 81). If the trunk is loaded correctly, the trunk partition closes automatically.
- ▶ Turn the SmartKey to position **2** in the ignition lock.
- ▶ Open the cover in the lower center console. Roof switch **1** is located under the cover.
- ▶ **To open:** pull roof switch **1** until the entire roof is stowed away in the trunk. The **Vario-Roof in Operation** message appears in the multifunction display. Once the opening procedure is complete, the message disappears and a tone sounds. All of the side windows open.
- ▶ **To close:** press and hold soft-top switch **1** until the soft top is fully closed. The **Vario-Roof in Operation** message appears in the multifunction display. Once the opening procedure is complete, the message disappears and a tone sounds.



All of the side windows open.

- ▶ To close all side windows, pull the switch under the cover of the center console (▷ page 88).

### Opening/closing using the SmartKey

#### Important safety notes





##### WARNING

When opening or closing the roof, body parts could be trapped by, for example, the roof mechanism, trunk lid or side windows. There is a risk of injury.

When raising or lowering the roof, make sure that no body parts are in the vicinity of moving components. If someone becomes trapped, release the button.

#### Opening and closing

This function is only available on vehicles with KEYLESS-GO or with roof comfort operation.

- ▶ Close the trunk lid (▷ page 81).  
If the trunk has been correctly loaded, the trunk partition is automatically closed.
- ▶ **Vehicles with comfort operation:** point the tip of the SmartKey at the driver's door handle.
- ▶ **Vehicles with KEYLESS-GO:** the SmartKey must be within 6 ft (2 m) of the vehicle.
- ▶ **To open:** press and hold the  button on the SmartKey until the roof is fully opened. The roof and the rear side windows open. The front side windows close.
- ▶ **To interrupt the opening procedure:** release the  button.
- ▶ **To open the front side windows:** press the  button on the SmartKey again.
- ▶ **To close:** press and hold the  button on the SmartKey until the roof is fully closed. The roof and the side windows close.
- ▶ **To interrupt the closing procedure:** release the  button.

### Locking the roof again



#### Important safety notes

##### WARNING

If you do not fully open/close the soft top, the soft-top hydraulics depressurize after a short time. This causes the soft top to lower unexpectedly and may cause you or others to be trapped. There is a risk of injury.

Always open or close the soft top completely.

The roof is not locked if:

- the  symbol and the **Vario-Roof in Operation** message appear in the multifunction display
- the  symbol and the **Open/Close Vario-Roof Completely** message appear in the multifunction display and you hear a warning tone
- you hear a warning tone for up to ten seconds when pulling away or while driving

#### Locking

You can lock the roof again if it is not locked fully.

- ▶ Pull over and stop the vehicle safely as soon as possible, paying attention to road and traffic conditions.
- ▶ Ensure that the SmartKey is in position  in the ignition lock.
- ▶ Press the roof switch (▷ page 91).

### Trunk partition

#### General notes

- ❗ To avoid damaging the roof or luggage when folding back the roof, you should:
  - only load the trunk to below the trunk partition
  - not place any objects on or in front of the trunk partition
  - not place any objects on the cover behind the roll bars
  - not allow the cargo to push the trunk partition upwards



**!** Make sure the trunk separator is completely closed. Otherwise, the roof can be blocked when it is opened or closed.

The trunk partition can be used to cover luggage and loads in the trunk.

## Opening and closing

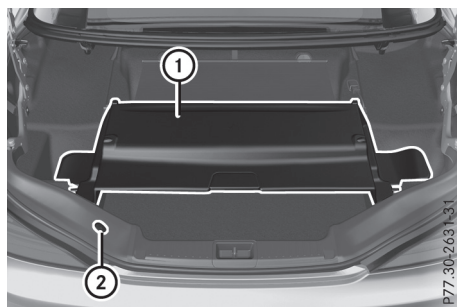

Trunk partition ① can be opened and closed using button ②, e.g. to check correct loading.

- ▶ **To open:** press button ②.
- ▶ **To close:** press button ②.  
If the trunk is loaded correctly, trunk partition ① is automatically closed to the full extent.

When the trunk lid is opened, trunk partition ① opens automatically.

## Removing and installing

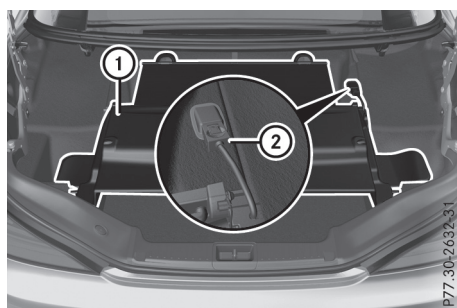

- ▶ **To remove:** close trunk partition ① (▷ page 93).
- ▶ To disconnect the electric plug connector, press the release catch on connector ② and remove connector ②.



- ▶ Unhook net ③ from holders ④ on both sides and guide it to the rear until it is completely rolled up.



- ▶ Turn catch lever ⑤ down in the direction of the arrow on both sides.  
Trunk partition ① is unlocked.
- ▶ Slide trunk partition cover ① forwards.
- ▶ Pull trunk partition ① out of the two guides in the direction of arrow ⑥.

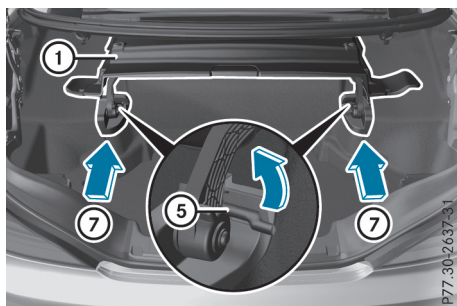

- ▶ **To install:** insert trunk partition ① into the two guides in the direction of arrow ⑦ to the stop.
- ▶ Turn catch lever ⑤ up in the direction of the arrow on both sides.  
Trunk partition ① is unlocked.

- ▶ Pull the net forwards and hook into the retainers on both sides.
- ▶ Push trunk partition cover ① back against the spring pressure and insert to the stop on both sides.

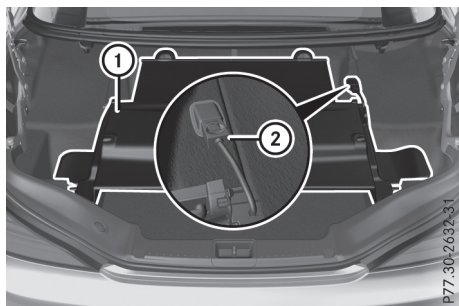

- ▶ Reconnect connector ② of the electric plug connector.

## Wind screen

### Electric wind screen

#### Important safety notes

##### WARNING

If you use the wind screen in darkness or in other conditions offering poor visibility, your view to the rear is further impaired. There is a risk of an accident.

Only use the wind screen when visibility conditions are good.

- ❗ When extending or retracting the wind screen, make sure there are no objects on the rear compartment trim. Otherwise, the objects could damage the wind screen.

The wind screen offers protection from the wind when driving with the roof down. The roof must be fully open before the wind screen can be extended.

#### Extending and retracting

- ▶ Open the roof (> page 90).
- ▶ Open the cover in the lower center console. The switch for the electrical wind screen is under the cover.

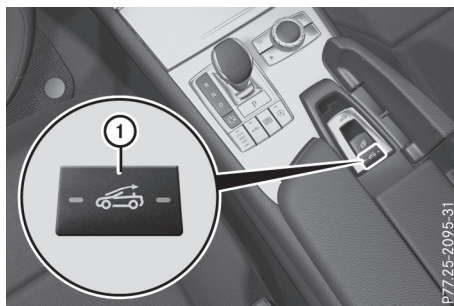

- ▶ **To extend:** press button ①.
- ▶ **To retract:** press button ① again.

### Roller sunblind for the panorama roof

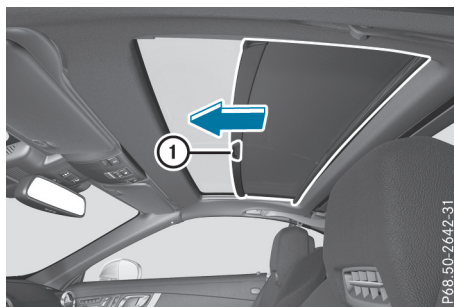

The roller sunblind protects you from excessive glare and heat caused by the sun shining through the panorama glass roof.

- ▶ **To close:** pull the roller sunblind in the direction of the arrow using handle ①.
- ▶ **To open:** slide the roller sunblind in the opposite direction to the arrow using handle ①.

## MAGIC SKY CONTROL

### General notes

MAGIC SKY CONTROL is a panorama roof, the transparency of which can be changed by applying electrical voltage.

MAGIC SKY CONTROL can be switched between darkened and transparent states.

MAGIC SKY CONTROL darkens automatically after a short period when you turn the Smart-

Key to position **0** in the ignition lock or remove the SmartKey.

### Risk of electric shock

**⚠ DANGER**

MAGIC SKY CONTROL operates using high voltage. If the trim behind the overhead control panel is damaged or removed, electrical components will be exposed. If you touch these components, you could get an electric shock. There is a risk of fatal injury.

- Never remove the trim behind the overhead control panel.
- If the trim is damaged, never touch the electrical components behind it.
- Always have work on the MAGIC SKY CONTROL carried out at a qualified specialist workshop.

The electrical components of MAGIC SKY CONTROL are protected by a paneling behind the overhead control panel.

The MAGIC SKY CONTROL control unit is marked with a yellow warning sticker that

warns you of high voltage. The electric cables of the high-voltage section are color orange.

### Operating MAGIC SKY CONTROL

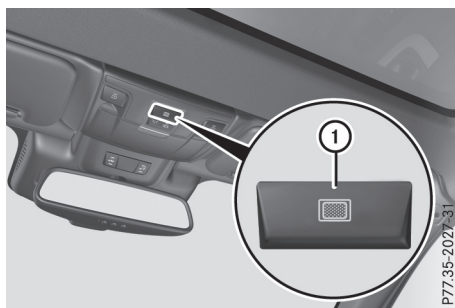

- ▶ Turn the SmartKey to position **1** or **2** in the ignition lock. MAGIC SKY CONTROL switches to the status it was set to before the engine was switched off.
- ▶ **To change the degree of transparency:** press button **1**.

At temperatures below freezing, the change is slower and uneven. The entire process may take some time.

### Problems with the roof

Problem	Possible causes/consequences and ▶ Solutions
The roof will not open or close.	The trunk partition is not closed. ▶ Close the trunk partition (▷ page 92).
	The net on the trunk partition is not attached. ▶ Attach the net (▷ page 92).
	The electrical plug connector on the trunk partition is disconnected. ▶ Connect the electrical plug connector to the trunk partition (▷ page 92).
	The trunk is incorrectly loaded. ▶ Only load the trunk to below the trunk partition
	The trunk lid is open. ▶ Close the trunk lid (▷ page 82).
	The on-board voltage is too low. ▶ Leave the engine running.

Problem	Possible causes/consequences and ► Solutions
	<p>The roof has been opened and closed several times in a row. The roof drive has switched off automatically. You can open and close the roof again after approximately ten minutes.</p> <ul style="list-style-type: none"><li>► Switch off the ignition and turn it back on.</li><li>► Repeat the opening or closing procedure.</li></ul>
	<p>The automatic roof system is faulty.</p> <ul style="list-style-type: none"><li>► Visit a qualified specialist workshop.</li></ul>

## Correct driver's seat position

### WARNING

You could lose control of your vehicle if you do the following while driving:

- adjust the driver's seat, head restraint, steering wheel or mirrors
- fasten the seat belt

There is a risk of an accident.

Adjust the driver's seat, head restraint, steering wheel and mirror and fasten your seat belt before starting the engine.



- ▶ Observe the safety guidelines on seat adjustment (▷ page 97).
- ▶ Make sure that seat ③ is adjusted properly. Electrical seat adjustment. (▷ page 99)

When adjusting the seat, make sure that:

- you are as far away from the driver's air bag as possible
- you are sitting in a normal upright position
- you can fasten the seat belt properly
- you have moved the backrest to an almost vertical position
- you have set the seat cushion angle so that your thighs are gently supported
- you can depress the pedals properly
- ▶ Check whether the head restraint is adjusted properly.

When doing so, make sure that you have adjusted the head restraint so that the back

of your head is supported at eye level by the center of the head restraint.

- ▶ Observe the safety notes on steering column adjustment (▷ page 103).
- ▶ Make sure that steering wheel ① is adjusted properly.

Adjusting the steering wheel electrically (▷ page 103)

When adjusting the steering wheel column, make sure that:

- you can hold the steering wheel with your arms slightly bent
- you can move your legs freely
- you can see all the displays in the instrument cluster clearly
- ▶ Observe the safety guidelines for seat belts (▷ page 42).
- ▶ Check whether you have fastened seat belt ② properly (▷ page 44).

The seat belt should:

- fit snugly across your body
- be routed across the middle of your shoulder
- be routed in your pelvic area across the hip joints
- ▶ Before starting off, adjust the rear-view mirror and the exterior mirrors (▷ page 105) in such a way that you have a good view of road and traffic conditions.
- ▶ Store the seat, steering wheel and exterior mirror settings using the memory function (▷ page 107).

## Seats

### Important safety notes

#### WARNING

Children could become trapped if they adjust the seats, particularly when unattended. There is a risk of injury.

When leaving the vehicle, always take the SmartKey with you and lock the vehicle. This also applies for the Digital Vehicle Key if the "Digital Vehicle Key" function is activated via Mercedes me connect. Never leave children unsupervised in the vehicle.

The seats can still be adjusted when there is no SmartKey in the ignition lock.

### WARNING

When you adjust a seat, you or other vehicle occupants could become trapped, e.g. on the seat guide rail. There is a risk of injury.

When adjusting a seat, make sure that no one has any body parts in the sweep of the seat.

### WARNING

If the driver's seat is not engaged, it could move forwards as far as the next catch during movement such as braking or abrupt changes of direction. As a result, you would be pushed against your seat belt by the unsecured driver's seat.

This could cause you to lose control of the vehicle. The seat belt cannot protect as intended and could result in additional injury.

There is a risk of an accident and injury.

Before every journey, make sure that the driver's seat is fully engaged.

Observe the safety notes on "Air bags" (▷ page 45) and "Children in the vehicle" (▷ page 57).

### WARNING

If you adjust the seat height carelessly, you or other vehicle occupants could be trapped and thereby injured. Children in particular could accidentally press the electrical seat adjustment buttons and become trapped. There is a risk of injury.

While moving the seats, make sure that your hands or other body parts do not get under the lever assembly of the seat adjustment system.

### WARNING

If the head restraints are not installed or not adjusted correctly, they cannot provide protection as intended. There is an increased risk of injury in the head and neck area, e.g. in the event of an accident or when braking.

Always drive with the head restraints installed. Before driving off, make sure for every vehicle occupant that the center of the head restraint supports the back of the head at about eye level.

### WARNING

You could lose control of your vehicle if you do the following while driving:

- adjust the driver's seat, head restraint, steering wheel or mirrors
- fasten the seat belt

There is a risk of an accident.

Adjust the driver's seat, head restraint, steering wheel and mirror and fasten your seat belt before starting the engine.

 To prevent damage to the seats and the seat heating, observe the following notes:

- Do not spill liquids onto the seats. Dry the seats as soon as possible if liquid does get spilled on the seats.
- If the seat covers are damp or wet, do not switch on the seat heating. Also, do not use the seat heating to dry the seats.
- Clean the seat covers as recommended; see the "Interior care" section.
- Do not transport heavy loads on the seats. Do not place pointed objects on the seat cushions such as knives, nails or tools. Where possible, use the seats only for carrying passengers.
- When operating the seat heating, do not cover the seats with insulating materials, e.g. blankets, coats, bags, protective covers, child seats or booster seats.
- When the seat heating is switched on, the seat surface can be damaged as a result of objects being placed on the seats, for example, seat cushions, child seats and protective covers not approved by Mercedes-Benz.

 Make sure that there are no objects in the footwell under or behind the seats when moving the seats back. There is a risk that the seats and/or the objects could be damaged.

 The head restraints cannot be removed.



For more information, contact a qualified specialist workshop.

### Adjusting the seats electrically

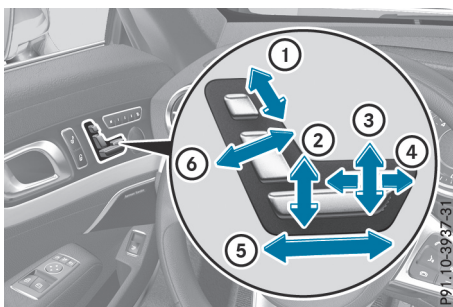

- ① Head restraint height
- ② Seat height
- ③ Seat cushion angle
- ④ Seat cushion length
- ⑤ Seat fore-and-aft adjustment
- ⑥ Backrest angle

**i** Further related subjects:

- You can store the seat settings using the memory function (▷ page 107).
- If PRE-SAFE® is triggered, the front-passenger seat will be moved to a better position if it was previously in an unfavorable position (▷ page 55).

### Adjusting the front-passenger seat from the driver's seat

**⚠ WARNING**

The front-air bags for could also injure the vehicle occupants in the front. If the front seats are positioned too close to the dashboard or steering wheel. This poses an increased risk of injury or even fatal injury. Always adjust the front seats so that they are as far from the front air bags as possible. Also observe the notes on the correct adjustment of the seats.

**!** Do not move the front-passenger seat fully forwards if there are objects in the parcel

net in the front-passenger footwell. The objects could otherwise be damaged.

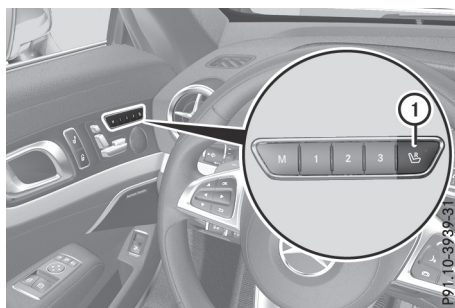

You can use the seat switches on the driver's side to adjust the front-passenger seat.

► **To activate/deactivate:** press button ①.

When the indicator lamp in button ① lights up, for the front-passenger seat you can:

- seat adjustment
- call up the memory function

### Removing the seat belt from the belt guide

**⚠ WARNING**

When driving off-road, your body is subject to forces from all directions, due to the uneven surface. You could be thrown from your seat, for instance. There is a risk of injury.

Always wear a seat belt, even when driving off-road.

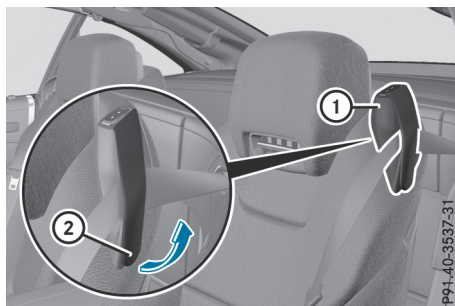

Both the driver's seat belt and the front-passenger seat belt can be removed from the



seat belt guide. This makes it easier to move the seats forward.

Before you drive off, the seat belt must be inserted into the seat belt guide.

Observe the safety guidelines for seat belts (▷ page 42).

- ▶ **To remove:** open up magnetic head ② and fold the tab up in the direction of the arrow.
- ▶ Take the seat belt out of seat belt guide ①.
- ▶ **To insert:** fold the tab up in the direction of the arrow.
- ▶ Insert the seat belt back into the seat belt guide and fold the tab back down.

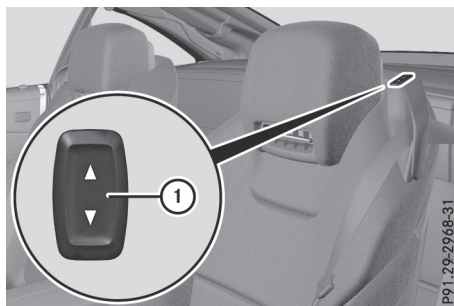

You can move the seat forwards in order to gain better access to the rear compartment, e.g. to reach the stowage compartment in the rear passenger compartment.

- ▶ Remove the seat belt from the seat belt guide (▷ page 99).
- ▶ **To move the seat forwards:** press  on switch ①. The seat moves automatically to the foremost position.
- ▶ **To move the seat backwards:** press  on switch ①. The seat moves back to the previous position.
- ▶ **To stop seat movement:** press  or  in the opposite direction.

### Adjusting the head restraints

#### WARNING

You could lose control of your vehicle if you do the following while driving:

- adjust the driver's seat, head restraint, steering wheel or mirrors
- fasten the seat belt

There is a risk of an accident.

Adjust the driver's seat, head restraint, steering wheel and mirror and fasten your seat belt before starting the engine.

- ▶ **To adjust the head restraint height:** slide the switch for the head restraint adjustment ① up or down in the direction of the arrow.

### Moving the seats forward/back

#### WARNING

When you adjust a seat, you or other vehicle occupants could become trapped, e.g. on the seat guide rail. There is a risk of injury.

When adjusting a seat, make sure that no one has any body parts in the sweep of the seat.

- ! Make sure that there are no containers in the cup holder and no objects in the footwell or behind the seats when adjusting the seats. Otherwise, you could damage the seats and the objects.

### Adjusting the multicontour seat

You can adjust the multicontour seat using COMAND (see Digital Operator's Manual).

### Adjusting the active multicontour seat

The active multicontour seat can be adjusted using COMAND (see the Digital Operator's Manual).

### Adjusting the 4-way lumbar support

You can adjust the 4-way lumbar support using COMAND (see the Digital Operator's Manual).

**Switching the seat heating on/off**

**Switching on/off**

**⚠ WARNING**

Repeatedly switching on the seat heating can cause the seat cushion and backrest pads to become very hot. The health of persons with limited temperature sensitivity or a limited ability to react to high temperatures may be affected or they may even suffer burn-like injuries. There is a risk of injury. Therefore, do not switch the seat heating on repeatedly.

**!** When the seat heating is switched on, the seat surface can be damaged as a result of objects being placed on the seats, for example, seat cushions, child seats and protective covers not approved by Mercedes-Benz. Ensure that there are no objects on the seat surface when the seat heating is switched on.

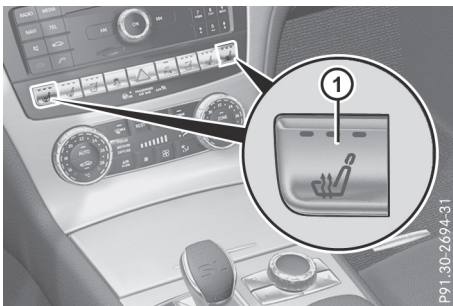

Driver's and front-passenger seat

The three red indicator lamps in the button indicate the heating level you have selected. The system automatically switches down from level **3** to level **2** after approximately eight minutes. The system automatically switches down from level **2** to level **1** after approximately ten minutes.

The system automatically switches off approximately 20 minutes after it is set to level **1**.

- ▶ Make sure that the SmartKey is in position **1** or **2** in the ignition lock.
- ▶ **To switch on:** press button **1** repeatedly until the desired heating level is set.
- ▶ **To switch off:** press button **1** repeatedly until all the indicator lamps go out.

**i** If the battery voltage is too low, the seat heating may switch off.

**Problems with the seat heating**

Problem	Possible causes/consequences and ▶ Solutions
The seat heating has switched off prematurely or cannot be switched on. The vehicle's electrical system voltage is too low because too many electrical consumers are switched on.	Switch off electrical consumers that you do not need, such as the rear window defroster or interior lighting. Once the battery is sufficiently charged, switch on the seat heating again.

## Switching the seat ventilation on/off

### Switching on/off

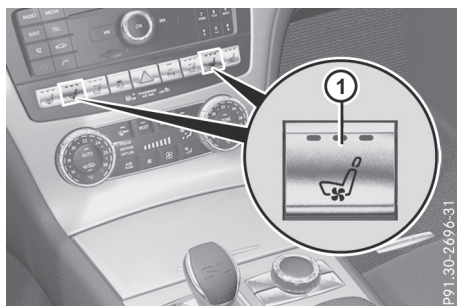

The three blue indicator lamps in the buttons indicate the blower setting you have selected.

- ▶ Ensure that the SmartKey is in position **2** in the ignition lock.
- ▶ **To switch on:** press button **1** repeatedly until the desired blower setting is set.
- ▶ **To switch off:** press button **1** repeatedly until all the indicator lamps go out.

- i** If the battery voltage is too low, the seat ventilation may switch off.
- i** If you open the roof using the SmartKey (> page 92), the driver's seat ventilation is automatically switched on and the side windows open.

### Problems with the seat ventilation

The seat ventilation has switched off prematurely or cannot be switched on. The vehicle's electrical system voltage is too low because too many electrical consumers are switched on.

- ▶ Switch off electrical consumers that you do not need, such as the rear window defroster or interior lighting.
- ▶ Once the battery is sufficiently charged, switch on the seat heating again.

## AIRSCARF

### Setting head level heating (AIRSCARF)

#### WARNING

When AIRSCARF is switched on, very hot air can flow from the vents in the head restraints. This could result in burns in the immediate vicinity of the air vents. There is a risk of injury.

Reduce the heater output before it becomes too hot.

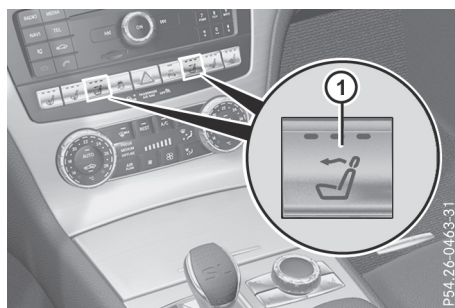

The AIRSCARF function warms the head and neck area of vehicle occupants with warm air. The warm air flows out of the holes in the head restraints.

The three red indicator lamps in the button indicate the heating level you have selected.

- ▶ Ensure that the SmartKey is in position **2** in the ignition lock.
- ▶ **To switch on:** press button **1**.  
Three red indicator lamps in the button light up. The blower starts up after a preheating phase of seven seconds.
- ▶ Press button **1** repeatedly until the desired heating level is set.
- ▶ **To switch off:** press button **1** repeatedly until all the indicator lamps go out.

- i** The blower continues running for seven seconds to cool down the heating elements.
- i** If the battery voltage is too low, AIRSCARF may switch off.

## Steering wheel

### Important safety notes

#### WARNING

You could lose control of your vehicle if you do the following while driving:

- adjust the driver's seat, head restraint, steering wheel or mirrors
- fasten the seat belt

There is a risk of an accident.

Adjust the driver's seat, head restraint, steering wheel and mirror and fasten your seat belt before starting the engine.

#### WARNING

Children could injure themselves if they adjust the steering wheel. There is a risk of injury.

Never leave children unsupervised in the vehicle.

When leaving the vehicle, always take the SmartKey with you and lock the vehicle. This also applies for the Digital Vehicle Key if the "Digital Vehicle Key" function is activated via Mercedes me connect.

The electrically adjustable steering wheel can still be adjusted when there is no SmartKey in the ignition lock.

### Adjusting the steering wheel electrically

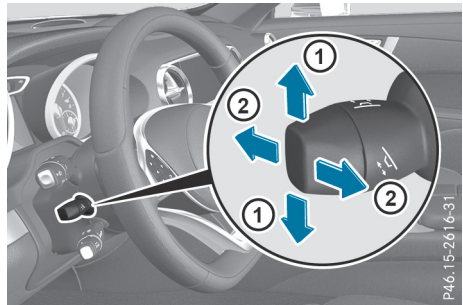

- ① Adjusts the steering wheel height
- ② Adjusts the steering wheel position (fore-and-aft adjustment)

#### Further related subjects:

- EASY-ENTRY/EXIT feature (▷ page 103)
- Storing settings (▷ page 107)

### EASY-ENTRY/EXIT feature

#### Important safety notes

#### WARNING

If you drive off while the EASY-ENTRY/EXIT feature is making adjustments, you could lose control of the vehicle. There is a risk of an accident.

Always wait until the adjustment process is complete before driving off.

#### WARNING

When the EASY-ENTRY/EXIT feature adjusts the steering wheel, you and other vehicle occupants – particularly children – could become trapped. There is a risk of injury.

While the EASY-ENTRY/EXIT feature is making adjustments, make sure that no one has any body parts in the sweep of the steering wheel.

If somebody becomes trapped:

- press one of the memory function position buttons, or
- move the switch for steering wheel adjustment in the opposite direction to that in which the steering wheel is moving.

The adjustment process is stopped.

### WARNING

When the EASY-ENTRY/EXIT feature adjusts the steering wheel and the driver's seat, you and other vehicle occupants – particularly children – could become trapped. There is a risk of injury.

While the EASY-ENTRY/EXIT feature is making adjustments, make sure that no one has any body parts in the sweep of the seat and the steering wheel.

If somebody becomes trapped:

- press one of the memory function position buttons, or
- press one of the memory function memory buttons, or
- move the switch for steering wheel adjustment in the opposite direction to that in which the steering wheel is moving

The adjustment process is stopped.

### WARNING

If you use openings in the bodywork or detachable parts as steps, you could:

- slip and/or fall
- damage the vehicle and cause yourself to fall.

There is a risk of injury.

Always use secure climbing aids, e.g. a suitable ladder.

The EASY-ENTRY/EXIT feature makes getting in and out of your vehicle easier.

You can activate and deactivate the EASY-ENTRY/EXIT feature in the on-board computer (▷ page 201).

## Position of the steering wheel when the EASY-ENTRY/EXIT feature is active

The steering wheel swings up when you:

- remove the SmartKey from the ignition lock
- open the driver's door with KEYLESS-GO in position 1
- open the driver's door and the SmartKey is in position **0** or **1**

 The steering wheel moves upwards only if it has not already reached the upper steering limiter.

## Position of the steering wheel for driving

The steering wheel is moved to the last selected position when:

- the driver's door is closed
- you insert the SmartKey into the ignition lock
- or
- you press the Start/Stop button once on vehicles with KEYLESS-GO

When you close the driver's door with the ignition switched on, the steering wheel is also automatically moved to the previously set position.

The last position of the steering column is stored when you switch off the ignition or when you store the setting with the memory function (▷ page 107).

## Crash-responsive EASY-EXIT feature

If the crash-responsive EASY-EXIT feature is triggered in an accident, the steering column will move upwards when the driver's door is opened. This occurs irrespective of the position of the SmartKey in the ignition lock. This makes it easier to exit the vehicle and rescue the occupants.

The crash-responsive EASY-EXIT feature is only operational if the EASY-EXIT/ENTRY feature is activated in the on-board computer (▷ page 201).

## Mirrors

### Exterior mirrors

#### Adjusting the exterior mirrors

##### WARNING

You could lose control of your vehicle if you do the following while driving:

- adjust the driver's seat, head restraint, steering wheel or mirrors
- fasten the seat belt

There is a risk of an accident.

Adjust the driver's seat, head restraint, steering wheel and mirror and fasten your seat belt before starting the engine.

##### WARNING

The exterior mirror on the front-passenger side reduces the size of the image. Visible objects are actually closer than they appear. This means that you could misjudge the distance from road users traveling behind, e.g. when changing lane. There is a risk of an accident.

For this reason, always make sure of the actual distance from the road users traveling behind by glancing over your shoulder.

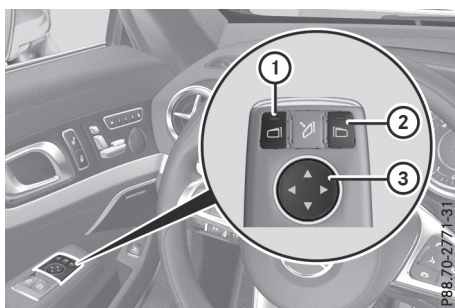

- ▶ Make sure that the SmartKey is in position **1** or **2** in the ignition lock.
- ▶ Press button **1** for the left exterior mirror or button **2** for the right exterior mirror. The indicator lamp in the corresponding button lights up in red. The indicator lamp goes out again after some time. You can adjust the selected

exterior mirror using button **3** as long as the indicator lamp is lit.

- ▶ Press button **3** up, down, to the right or to the left.

The exterior mirror must be set to a position that provides you with a good overview of traffic conditions.

The convex exterior mirrors provide a larger field of vision.

The exterior mirrors are automatically heated after starting the vehicle if the rear window defroster is switched on and the outside temperature is low. Mirror heating lasts up to 10 minutes.

- i** You can also heat up the exterior mirrors manually by switching on the rear window defroster.

#### Folding the exterior mirrors in or out electrically



- ▶ Make sure that the SmartKey is in position **1** or **2** in the ignition lock.
- ▶ Briefly press button **1**. Both exterior mirrors fold in or out.
- i** Make sure that the exterior mirrors are always folded out fully while driving. They could otherwise vibrate.

#### Exterior mirror pushed out of position

If an exterior mirror has been pushed out of position, proceed as follows:

- ▶ Move the exterior mirror into the correct position manually. The mirror housing is engaged again and you can adjust the exterior mirrors as usual (▷ page 105).



### Automatic anti-glare mirrors

#### WARNING

Electrolyte may escape if the glass in an automatic anti-glare mirror breaks. The electrolyte is harmful and causes irritation. It must not come into contact with your skin, eyes, respiratory organs or clothing or be swallowed. There is a risk of injury.

If you come into contact with the electrolyte, observe the following:

- Rinse off the electrolyte from your skin immediately with water.
- Immediately rinse the electrolyte out of your eyes thoroughly with clean water.
- If the electrolyte is swallowed, immediately rinse your mouth out thoroughly. Do not induce vomiting.
- If electrolyte comes into contact with your skin or hair or is swallowed, seek medical attention immediately.
- Immediately change out of clothing which has come into contact with electrolyte.
- If an allergic reaction occurs, seek medical attention immediately.

The rear-view mirror and the exterior mirror on the driver's side automatically go into anti-glare mode if the following conditions are met simultaneously:

- the ignition is switched on and
- incident light from headlamps strikes the sensor in the rear-view mirror

The mirrors do not go into anti-glare mode if reverse gear is engaged or if the interior lighting is switched on.

### Parking position for the exterior mirror on the front-passenger side

#### Setting and storing the parking position

##### Using the memory button

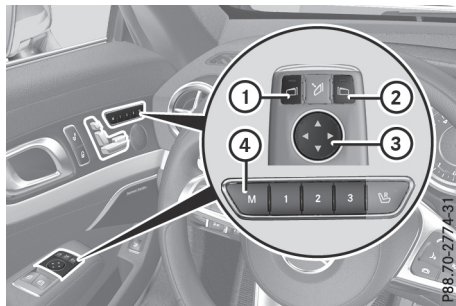

You can store the parking position of the front-passenger-side exterior mirror using memory button **M** (4). The reverse gear must not be engaged during the process.

- ▶ Make sure that the vehicle is stationary and that the SmartKey is in position **2** in the ignition lock.
- ▶ Press button **2** for the exterior mirror on the front-passenger side.
- ▶ Engage reverse gear. The exterior mirror on the front-passenger side moves to the preset parking position.
- ▶ Use button **3** to adjust the exterior mirror to a position that allows you to see the rear wheel and the curb. The parking position is stored.

**i** If you shift the transmission to another position, the exterior mirror on the front-passenger side returns to the driving position.



## Using reverse gear

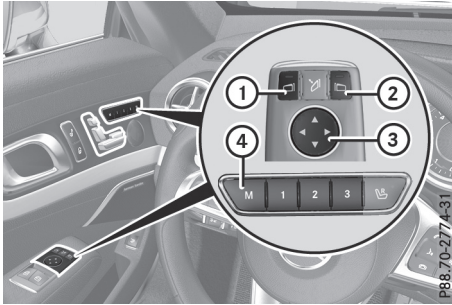

You can adjust the exterior mirror on the front-passenger side to a position that allows you to see the rear wheel on that side as soon as you engage reverse gear. This setting can be stored using memory button **M** ④.

- ▶ Ensure that the SmartKey is in position ② in the ignition lock.
- ▶ With the exterior mirror on the front-passenger side activated, use button ③ to adjust the exterior mirror. The rear wheel and the curb should be visible in the exterior mirror.
- ▶ Press memory button **M** ④ and one of the arrows on button ③ within three seconds. The parking position is stored if the exterior mirror does not move.
- ▶ If the mirror moves out of position, repeat the steps.

## Calling up a stored parking position setting

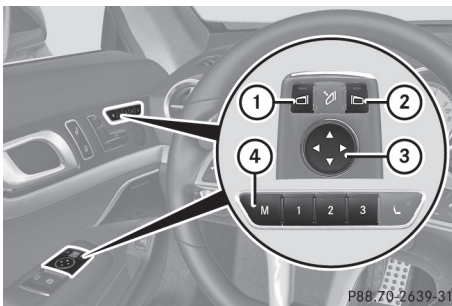

- ▶ Turn the SmartKey to position ② in the ignition lock.
- ▶ Select the exterior mirror on the front-passenger side using button ②.
- ▶ Engage reverse gear. The exterior mirror on the front-passenger side moves to the stored parking position.

The exterior mirror on the front-passenger side moves back to its original position:

- as soon as you exceed a speed of 9 mph (15 km/h)
- if you press button ① for the exterior mirror on the driver's side

## Memory function

### Storing settings

#### WARNING

If you use the memory function on the driver's side while driving, you could lose control of the vehicle as a result of the adjustments being made. There is a risk of an accident.

Only use the memory function on the driver's side when the vehicle is stationary.

#### WARNING

When the memory function adjusts the seat, you and other vehicle occupants – particularly children – could become trapped. There is a risk of injury.

While the memory function is making adjustments, make sure that no one has any body parts in the sweep of the seat.

If someone becomes trapped, press a memory position switch or seat adjustment switch immediately.

#### WARNING

Children could become trapped if they activate the memory function, particularly when unattended. There is a risk of injury.

Never leave children unsupervised in the vehicle.

When leaving the vehicle, always take the SmartKey with you and lock the vehicle. This also applies for the Digital Vehicle Key if the "Digital Vehicle Key" function is activated via Mercedes me connect.

The memory function can be activated at any time, e.g. even when the SmartKey is not in the ignition lock.

With the memory function, you can store up to three different settings, e.g. for three different people.

The following settings are stored as a single memory preset:

- Position of the seat, backrest and head restraint
- Driver's side: steering wheel position
- Driver's side: position of the exterior mirrors on the driver's and front-passenger sides

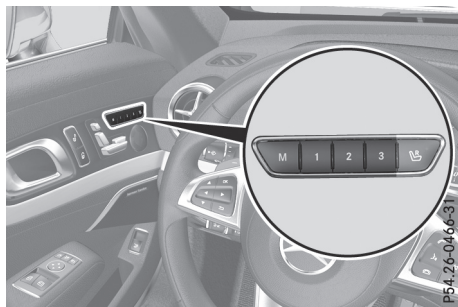

- ▶ Adjust the seat electrically (▷ page 99).
- ▶ On the driver's side, adjust the steering wheel (▷ page 103) and the exterior mirrors (▷ page 105).
- ▶ Press memory button **M** and one of the storage position buttons **1**, **2** or **3** within three seconds.

The settings are stored in the selected pre-set position. A tone sounds when the settings have been completed.

### Calling up a stored setting

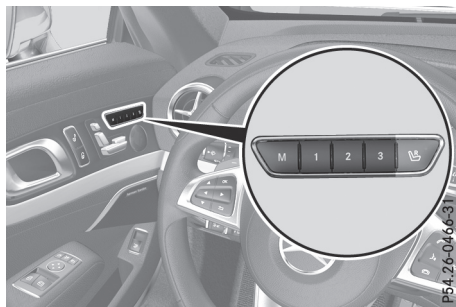

- ▶ Press and hold the relevant storage position button **1**, **2** or **3** until the seat, steering wheel and exterior mirrors are in the stored position.

**i** The setting procedure is interrupted as soon as you release the storage position button.

## Exterior lighting

### General notes

For reasons of safety, Mercedes-Benz recommends that you drive with the lights switched on even during the daytime. In some countries, operation of the headlamps varies due to legal requirements and self-imposed obligations.

### Setting the exterior lighting

#### Setting options

Exterior lighting can be set using:

- the light switch
- the combination switch (▷ page 110)
- the on-board computer (▷ page 200)

#### Light switch

##### Operation

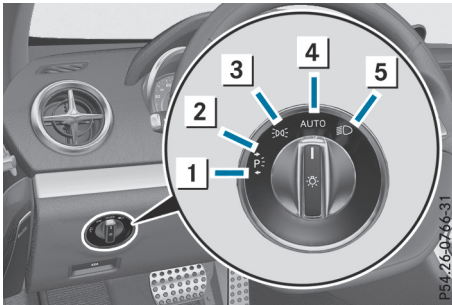

- |   |  |  |
|---|--|--|
| 1 |  | Left-hand standing lamps                                     |
| 2 |  | Right-hand standing lamps                                    |
| 3 |  | Parking lamps, license plate and instrument cluster lighting |
| 4 |  | Automatic headlamp mode, controlled by the light sensor      |
| 5 |  | Low-beam/high-beam headlamps                                 |
| 6 |  | Rear fog lamp  |
| 6 |  | Rear fog lamp  |

If you hear a warning tone when you leave the vehicle, the lights may still be switched on.

- ▶ Turn the light switch to **AUTO**.

The exterior lighting (except the parking/standing lamps) switches off automatically if you:

- remove the SmartKey from the ignition lock
- open the driver's door while the SmartKey is in position **0** in the ignition lock

#### Automatic headlamp mode

##### WARNING

When the light switch is set to **AUTO**, the low-beam headlamps may not be switched on automatically if there is fog, snow or other causes of poor visibility due to the weather conditions such as spray. There is a risk of an accident.

In such situations, turn the light switch to .

The automatic headlamp feature is only an aid. The driver is responsible for the vehicle's lighting at all times.

**AUTO** is the preferred light switch position:

- The light setting is automatically selected according to the brightness of the ambient light (exception: poor visibility due to weather conditions such as fog, snow or spray).
- With the SmartKey in position **1** in the ignition lock: the parking lamps are switched on or off automatically depending on the brightness of the ambient light.
- With the engine running: if you have activated the daytime running lamps function via the on-board computer, the daytime running lamps or the parking lamps and the low-beam headlamps are switched on or off automatically depending on the brightness of the ambient light.

- ▶ **To switch on automatic headlamp mode:** turn the light switch to **AUTO**.

##### Canada only:

The daytime running lamps improve the visibility of your vehicle during the day. The daytime running lamps function is required by law in Canada. It cannot therefore be deactivated.



When the engine is running and the vehicle is stationary: if you shift the automatic transmission from a driving position to position **P** the daytime running lamps or low-beam headlamps go out after 3 minutes.

When the engine is running, the vehicle is stationary and in bright ambient light: if you turn the light switch to the  position, the daytime running lamps and parking lamps switch on.

If the engine is running and you turn the light switch to , the manual settings take precedence over the daytime running lamps.

#### USA only:

The daytime running lamps improve the visibility of your vehicle during the day. To do this, the daytime running lamps function must be switched on using the on-board computer (▷ page 200).

If the engine is running and you turn the light switch to  or , the manual settings take precedence over the daytime running lamps.



#### Low-beam headlamps

##### WARNING

When the light switch is set to **AUTO**, the low-beam headlamps may not be switched on automatically if there is fog, snow or other causes of poor visibility due to the weather conditions such as spray. There is a risk of an accident.



In such situations, turn the light switch to .



Even if the light sensor does not detect that it is dark, the parking lamps and low-beam headlamps switch on when the ignition is switched on and the light switch is set to the  position. This is a particularly useful function in the event of rain and fog.

- ▶ **To switch on the low-beam headlamps:** turn the SmartKey to position **2** in the ignition lock or start the engine.
- ▶ Turn the light switch to . The green  indicator lamp in the instrument cluster lights up.

#### Parking lamps



**!** If the battery charge is very low, the parking lamps or standing lamps are automatically switched off to enable the next engine start. Always park your vehicle safely and in a well lit area, in accordance with the relevant legal stipulations. Avoid using the  parking lamps over a period of several

hours. If possible, switch on the right-hand  or left-hand  standing lamps.

- ▶ **To switch on:** turn the light switch to . The green  indicator lamp in the instrument cluster lights up.

#### Standing lamps

Switching on the standing lamps ensures the corresponding side of the vehicle is illuminated.

- ▶ **To switch on the standing lamps:** the SmartKey is not in the ignition lock or it is in position **0** in the ignition lock.
- ▶ Turn the light switch to  (left-hand side of the vehicle) or  (right-hand side of the vehicle).

#### Combination switch

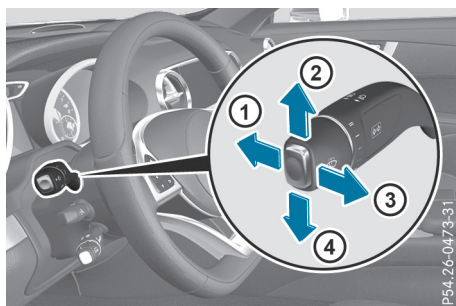

- ① High-beam headlamps
  - ② Turn signal, right
  - ③ High-beam flasher
  - ④ Turn signal, left
- ▶ **To indicate briefly:** press the combination switch briefly to the pressure point in the direction of arrow **2** or **4**. The corresponding turn signal flashes three times.
  - ▶ **To indicate:** press the combination switch beyond the pressure point in the direction of arrow **2** or **4**.
  - ▶ **To switch on the high-beam headlamps:** turn the light switch to  or **AUTO**.
  - ▶ Press the combination switch beyond the pressure point in the direction of arrow **1**. In the **AUTO** position, the high-beam headlamps are only switched on when it is dark and the engine is running.

The blue  indicator lamp in the instrument cluster lights up when the high-beam headlamps are switched on.

- ▶ **To switch off the high-beam headlamps:** move the combination switch back to its normal position.

The blue  indicator lamp in the instrument cluster goes out.

### Hazard warning lamps

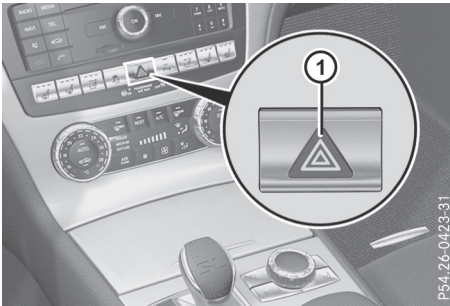

- ▶ **To switch on the hazard warning lamps:** press button ①.

All turn signals flash. If you now switch on a turn signal using the combination switch, only the turn signal lamp on the corresponding side of the vehicle will flash.

- ▶ **To switch off the hazard warning lamps:** press button ①.

The hazard warning lamps automatically switch on if:

- an air bag is deployed or
- the vehicle decelerates rapidly from a speed of above 45 mph (70 km/h) and comes to a standstill

The hazard warning lamps switch off automatically if the vehicle reaches a speed of above 6 mph (10 km/h) again after a full brake application.

- ❗ The hazard warning lamps still operate if the ignition is switched off.

### Cornering light function

The cornering light function improves the illumination of the road over a wide angle in the direction you are turning, enabling better visibility in tight bends, for example. The corner-

ing light function can only be activated when the low-beam headlamps are switched on.

#### Active:

- if you are driving at speeds below 25 mph (40 km/h) and switch on the turn signal or turn the steering wheel
- if you are driving at speeds between 25 mph (40 km/h) and 45 mph (70 km/h) and turn the steering wheel

The cornering lamp may remain lit for a short time, but is automatically switched off after no more than three minutes.

#### Cornering light function with traffic circle function:

The cornering light function is activated on both sides before entering a traffic circle through an evaluation of the current GPS position of the vehicle. It remains active until after the vehicle has left the traffic circle. In this way, pedestrians crossing the road, for example, are illuminated by your vehicle in good time.

### Active light function

The active light function is a system that moves the headlamps according to the steering movements of the front wheels. In this way, relevant areas remain illuminated while driving. This allows you to recognize pedestrians, cyclists and animals sooner.

**Active:** when the lights are switched on.

Vehicles with Lane Keeping Assist: the active light function evaluates the course of the lane in which you are driving and pre-emptively controls the active light function.

### Adaptive Highbeam Assist

#### General notes

You can use this function to set the headlamps to change between low beam and high beam automatically. The system recognizes vehicles with their lights on, either approaching from the opposite direction or traveling in front of your vehicle, and consequently switches the headlamps from high beam to low beam.

The system automatically adapts the low-beam headlamp range depending on the distance to the other vehicle. Once the system no longer

detects any other vehicles, it reactivates the high-beam headlamps.

The system's optical sensor is located behind the windshield near the overhead control panel.

### Important safety notes

#### WARNING

Adaptive Highbeam Assist does not recognize road users:

- who have no lights, e.g. pedestrians
- who have poor lighting, e.g. cyclists
- whose lighting is blocked, e.g. by a barrier

On very rare occasions, Adaptive Highbeam Assist may fail to recognize other road users that have lights, or may recognize them too late. In this, or in similar situations, the automatic high-beam headlamps will not be deactivated or will be activated regardless. There is a risk of an accident.

Always carefully observe the traffic conditions and switch off the high-beam headlamps in good time.

Adaptive Highbeam Assist cannot take into account road, weather or traffic conditions. Adaptive Highbeam Assist is only an aid. You are responsible for adjusting the vehicle's lighting to the prevailing light, visibility and traffic conditions.

In particular, the detection of obstacles can be restricted if there is:

- poor visibility, e.g. due to fog, heavy rain or snow
- dirt on the sensors or the sensors are obscured

### Switching Adaptive Highbeam Assist on/off



- ▶ **To switch on:** turn the light switch to **AUTO**.
- ▶ Press the combination switch beyond the pressure point in the direction of arrow ①. The  indicator lamp in the multifunction display lights up when it is dark and the light sensor activates the low-beam headlamps. If you are driving at speeds above approximately 16 mph (25 km/h):

The headlamp range is set automatically depending on the distance between the vehicle and other road users.

If you are driving at speeds above approximately 19 mph (30 km/h) and no other road users have been detected:

The high-beam headlamps are switched on automatically. The  indicator lamp in the instrument cluster also lights up.

If you are driving at speeds below approximately 16 mph (25 km/h) or other road users have been detected or the roads are adequately lit:

The high-beam headlamps are switched off automatically. The  indicator lamp in the instrument cluster goes out. The  indicator lamp in the multifunction display remains lit.



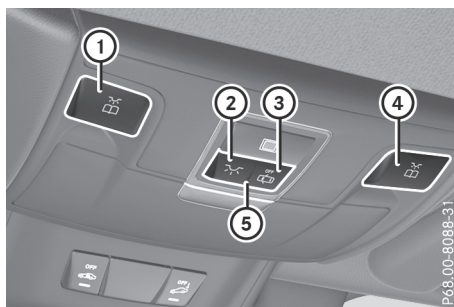

- ▶ **To switch off:** move the combination switch back to its normal position or move the light switch to another position. The  indicator lamp in the multifunction display goes out.

## Interior lighting

### Overview of interior lighting



Overhead control panel

- ①  Switches the left-hand reading lamp on/off
- ②  Switches the interior lighting on
- ③  Switches the interior lighting/automatic interior lighting control off
- ④  Switches the right-hand reading lamp on/off
- ⑤  Switches the automatic interior lighting control on



## Interior lighting control

### General notes

In order to prevent the vehicle's battery from discharging, the interior lighting functions are automatically deactivated after some time, unless the SmartKey is in position **2** in the ignition lock.

The color and brightness of the ambient lighting are set via the multimedia system (▷ page 200).

### Automatic interior lighting control

► **To switch on:** set the switch to center position **5**.

► **To switch off:** set the switch to the  position.

The interior lighting automatically switches on if you:

- unlock the vehicle
- open a door
- remove the SmartKey from the ignition lock

The interior lighting is switched on for a set time when the SmartKey is removed from the ignition lock. You can activate this delayed switch-off using the on-board computer (▷ page 201).

## Replacing bulbs

The front and rear lamps of your vehicle are equipped with LED bulbs. Do not replace the bulbs yourself. Contact a qualified specialist workshop which has the necessary specialist knowledge and tools to carry out the work required.

Bulbs and lamps are an important aspect of vehicle safety. You must therefore make sure that these function correctly at all times. Have the headlamp setting checked regularly.

## Windshield wipers

### Switching the windshield wipers on/off

**!** Do not operate the windshield wipers when the windshield is dry, as this could

damage the wiper blades. Moreover, dust that has collected on the windshield can scratch the glass if wiping takes place when the windshield is dry.

If it is necessary to switch on the windshield wipers in dry weather conditions, always use washer fluid when operating the windshield wipers.





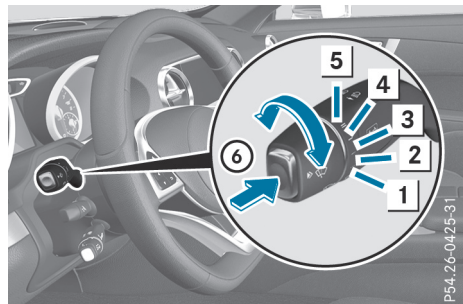

**!** If the windshield wipers leave smears on the windshield after the vehicle has been washed in an automatic car wash, wax or other residues may be the reason for this. Clean the windshield using washer fluid after washing the vehicle in an automatic car wash.

**!** Intermittent wiping with rain sensor: due to optical influences and the windshield becoming dirty in dry weather conditions, the windshield wipers may be activated inadvertently. This could then damage the windshield wiper blades or scratch the windshield.

For this reason, you should always switch off the windshield wipers in dry weather.



Combination switch

- |          |   |   |
|----------|---|---|
| <b>1</b> |  | Windshield wiper off  |
| <b>2</b> |  | Intermittent wipe, low (rain sensor set to low sensitivity)   |
| <b>3</b> |  | Intermittent wipe, high (rain sensor set to high sensitivity)   |
| <b>4</b> |  | Continuous wipe, slow   |
| <b>5</b> |  | Continuous wipe, fast   |
| <b>6</b> |  | Single wipe /  Wipes the windshield using washer fluid |

If the wiper blades are worn, the windshield will no longer be wiped properly. This could prevent you from observing the traffic conditions.

## Replacing the wiper blades

### Important safety notes

#### WARNING

If the windshield wipers begin to move while you are changing the wiper blades, you could be trapped by the wiper arm. There is a risk of injury.

Always switch off the windshield wipers and ignition before changing the wiper blades.

**!** To avoid damaging the wiper blades, make sure that you touch only the wiper arm of the wiper.

**!** Never open the hood if a windshield wiper arm has been folded away from the windshield.

Never fold a windshield wiper arm without a wiper blade back onto the windshield.

Hold the windshield wiper arm firmly when you change the wiper blade. If you release the windshield wiper arm without a wiper blade and it falls onto the windshield, the windshield may be damaged by the force of the impact.

Mercedes-Benz recommends that you have the wiper blades changed at a qualified specialist workshop.

**!** Always position the windshield wiper arms vertically before folding them away from the windshield. By doing so, you will avoid damage to the hood.

## Replacing the windshield wiper blades

### Moving the wiper arm to a vertical position

#### On vehicles without KEYLESS-GO:

- ▶ Turn the SmartKey to position **1** or **2** in the ignition lock.
- ▶ Set the windshield wiper to position **—**.
- ▶ When the wiper arms are vertical to the hood, turn the SmartKey to position **0** in the ignition lock and remove it.
- ▶ Fold the wiper arm away from the windshield until you feel it engage.

#### On vehicles with KEYLESS-GO:

- ▶ Switch off the engine.
- ▶ Remove your foot from the brake pedal.
- ▶ Set the windshield wiper to the **—** position.
- ▶ Press the Start/Stop button repeatedly until the windshield wiper starts.
- ▶ When the wiper arms are in a vertical position to the hood, press the Start/Stop button.
- ▶ Fold the wiper arm away from the windshield until you feel it engage.

### Removing a wiper blade

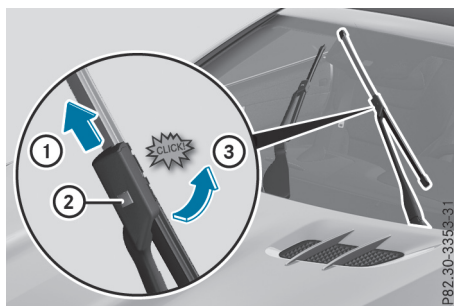

- ▶ **To bring the wiper blade into position to be removed:** hold the wiper arm firmly with one hand. With the other hand, turn the wiper blade in the direction of arrow **3** beyond the point of resistance. The wiper blade engages in the removal position with an audible click.
- ▶ **To remove a wiper blade:** firmly press release knob **2** and pull the wiper blade upwards **1**.

### Installing the wiper blades

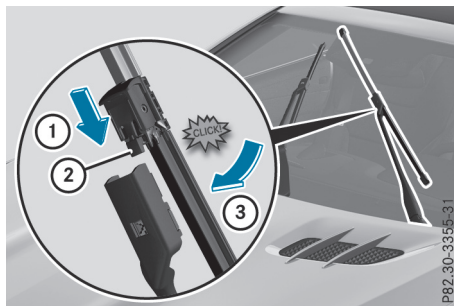

- ▶ Push the new wiper blade in the direction of arrow ① onto the wiper arm until lug ② engages.
- ▶ Push the wiper blade out of the removal position in the direction of arrow ③ beyond the point of resistance.  
The wiper blade disengages with an audible click and is freely movable again.
- ▶ Make sure that the wiper blade is seated correctly.
- ▶ Fold the wiper arm back onto the windshield.

### Problems with the windshield wipers

Problem	Possible causes/consequences and ▶ Solutions
The windshield wipers are jammed.	Leaves or snow, for example, may be obstructing the windshield wiper movement. The wiper motor has been deactivated. <ul style="list-style-type: none"> <li>▶ For safety reasons, you should remove the SmartKey from the ignition lock.</li> </ul> or <ul style="list-style-type: none"> <li>▶ Switch off the engine using the Start/Stop button and open the driver's door.</li> <li>▶ Remove the cause of the obstruction.</li> <li>▶ Switch the windshield wipers back on.</li> </ul>
The windshield wipers fail completely.	The windshield wiper drive is malfunctioning. <ul style="list-style-type: none"> <li>▶ Select another wiper speed on the combination switch.</li> <li>▶ Have the windshield wipers checked at a qualified specialist workshop.</li> </ul>

## Overview of climate control systems

### General notes

Observe the settings recommended on the following pages. The windows could otherwise fog up.

To prevent the windows from fogging up:

- switch off climate control only briefly
- switch on air-recirculation mode only briefly
- switch on the cooling with air dehumidification function
- switch on the defrost windshield function briefly, if required

Climate control regulates the temperature and the humidity in the vehicle interior and filters undesirable substances out of the air.

Climate control can only be operated when the engine is running. Optimum operation is only achieved with the side windows and roof closed.

- i** When the weather is warm, ventilate the vehicle for a brief period. This will speed up the cooling process and the desired vehicle interior temperature will be reached more quickly.
- i** It is possible that the dehumidification function of the climate control system may be activated automatically an hour after the SmartKey has been removed. The vehicle is then ventilated for 30 minutes to dry the air-conditioning system.

### Control panel for dual-zone automatic climate control

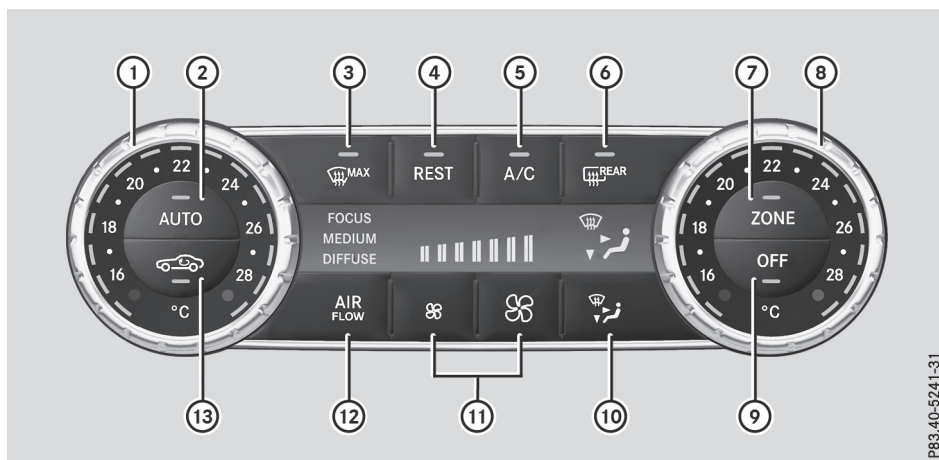

P83\_40-5241-31

Canada only

- ① Sets the temperature, left (▷ page 119)
- ② Sets climate control to automatic (▷ page 119)
- ③ Defrosts the windshield (▷ page 120)
- ④ Switches the residual heat on or off (▷ page 122)
- ⑤ Switches cooling with air dehumidification on/off (▷ page 118)
- ⑥ Switches the rear window defroster on/off (▷ page 121)
- ⑦ Switches the ZONE function on/off (▷ page 120)
- ⑧ Sets the temperature, right (▷ page 119)
- ⑨ Activates/deactivates climate control (▷ page 118)
- ⑩ Sets the air distribution (▷ page 120)
- ⑪ Sets the airflow (▷ page 120)

- ⑫ Adjusts the climate mode settings (▷ page 119)
- ⑬ Switches air-recirculation mode on/off (▷ page 122)

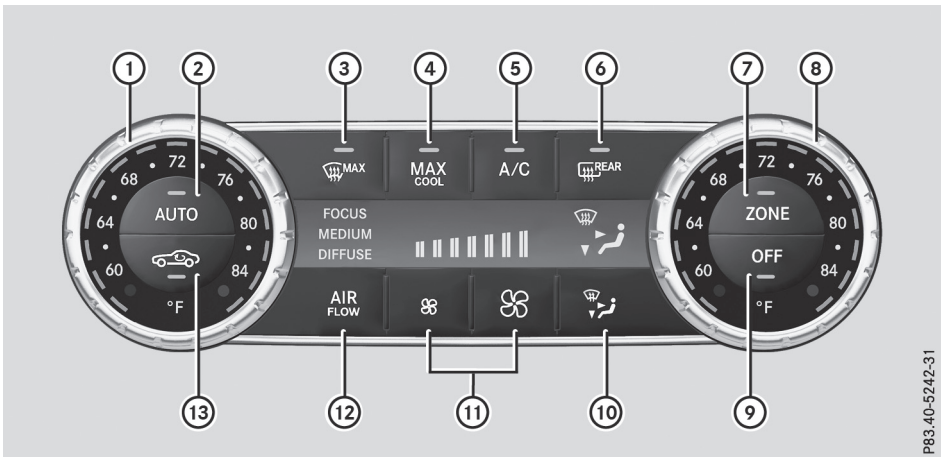

PB3-40-5242-31

USA only

- ① Sets the temperature, left (▷ page 119)
- ② Sets climate control to automatic (▷ page 119)
- ③ Defrosts the windshield (▷ page 120)
- ④ Switches the maximum cooling MAX COOL on or off (▷ page 121)
- ⑤ Switches cooling with air dehumidification on/off (▷ page 118)
- ⑥ Switches the rear window defroster on/off (▷ page 121)
- ⑦ Switches the ZONE function on/off (▷ page 120)
- ⑧ Sets the temperature, right (▷ page 119)
- ⑨ Activates/deactivates climate control (▷ page 118)
- ⑩ Sets the air distribution (▷ page 120)
- ⑪ Sets the airflow (▷ page 120)
- ⑫ Adjusts the climate mode settings (▷ page 119)
- ⑬ Switches air-recirculation mode on/off (▷ page 122)

### Optimum use of dual-zone automatic climate control

#### Climate control system

The following contains instructions and recommendations to enable you to get the most out of your 3-zone automatic climate control.

- Activate climate control using the **AUTO** and **A/C** buttons on the control panel of the climate control. The indicator lamps in the **AUTO** and **A/C** buttons light up.
- In automatic mode, the **AIR FLOW** button on the climate control panel may be used to additionally adjust the airflow (FOCUS/MEDIUM/DIFFUSE). The MEDIUM level is recommended.
- Set the temperature to 72 °F (22 °C).
- Only use the "Windshield defrosting" function briefly until the windshield is clear again.
- Only use air-recirculation mode briefly, e.g. if there are unpleasant outside odors or when in a tunnel. The windows could otherwise fog up, since no fresh air is drawn into the vehicle in air-recirculation mode.
- Use the ZONE function to adopt the temperature settings on the driver's side for the front-passenger side as well. The indicator lamp in the **ZONE** button goes out.

- Use the residual heat function if you want to heat or ventilate the vehicle interior when the ignition is switched off. The residual heat function can only be activated or deactivated with the ignition switched off.
- **Vehicles with COMAND:** if you change the settings of the climate control system, the climate status display appears for three seconds at the bottom of the screen in the COMAND display. You will see the current settings of the various climate control functions.

### ECO start/stop function

During automatic engine switch-off, the climate control system only operates at a reduced capacity. If you require full climate control capacity, the ECO start/stop function can be deactivated by pressing the ECO button (▷ page 130).

## Operating the climate control systems

### Activating/deactivating climate control

#### General notes

When the climate control is switched off, the air supply and air circulation are also switched off. The windows could fog up. Therefore, switch off climate control only briefly

- ❗ Activate climate control primarily using the **AUTO** button (▷ page 119).

### Activating/deactivating

- ▶ Turn the SmartKey to position **2** in the ignition lock (▷ page 126).
  - ▶ **To activate:** press the **AUTO** button. The indicator lamp in the **AUTO** button lights up. Airflow and air distribution are set to automatic mode.
- or
- ▶ Press the **OFF** button. The indicator lamp in the **OFF** button goes out. The previously selected settings are restored.
  - ▶ **To deactivate:** press the **OFF** button. The indicator lamp in the **OFF** button lights up.

### Switching cooling with air dehumidification on/off

#### General notes

If you deactivate the "Cooling with air-dehumidification" function, the air inside the vehicle will not be cooled. The air inside the vehicle will also not be dehumidified. The windows can fog up more quickly. Therefore, deactivate the cooling with air-dehumidification function only briefly.

The "Cooling with air dehumidification" function is only available when the engine is running. The air inside the vehicle is cooled and dehumidified according to the temperature selected.

Condensation may drip from the underside of the vehicle when it is in cooling mode. This is normal and not a sign that there is a malfunction.

### Activating/deactivating

- ▶ **To activate:** press the **A/C** button. The indicator lamp in the **A/C** button lights up.
  - ▶ **To deactivate:** press the **A/C** button. The indicator lamp in the **A/C** or **A/C REST** button goes out. The "Cooling with air dehumidification" function has a delayed switch-off feature.
- The indicator lamp in the **A/C** button goes out. The "Cooling with air dehumidification" function has a delayed switch-off feature.



## Problems with the "Cooling with air dehumidification" function

Problem	Possible causes/consequences and ► Solutions
The indicator lamp in the  button flashes three times or remains off. The "Cooling with air dehumidification" function cannot be switched on.	Cooling with air dehumidification has been deactivated due to a malfunction. ► Visit a qualified specialist workshop.

### Setting climate control to automatic







#### General notes

In automatic mode, the set temperature is maintained automatically at a constant level. The system automatically regulates the temperature of the dispensed air, the airflow and the air distribution.

The automatic mode functions optimally when the "Cooling with air dehumidification" function is activated. If necessary, cooling with air dehumidification can be deactivated.

If you deactivate the "Cooling with air-dehumidification" function, the air inside the vehicle will not be cooled. The air inside the vehicle will also not be dehumidified. The windows can fog up more quickly. Therefore, deactivate the cooling with air-dehumidification function only briefly.



#### Automatic control

- Turn the SmartKey to position  in the ignition lock (► page 126).
  - Set the desired temperature.
  - **To activate:** press the  button.  
The indicator lamp in the  button lights up. Automatic air distribution and airflow are activated.
  - i** When automatic mode is enabled, the climate mode can be selected (► page 119).
  - **To switch to manual mode:** press the  button.
- or
- Press the  or  button.  
The indicator lamp in the  button goes out.

### Adjusting the climate mode settings





You can select the following climate mode settings in automatic mode:

- FOCUS high airflow, slightly cooler setting
- MEDIUM medium airflow, standard setting
- DIFFUSE low airflow, slightly warmer and draft-free setting

- Turn the SmartKey to position  in the ignition lock (► page 126).
- Press the  button.
- Press the  button repeatedly until the desired climate mode appears in the display.

### Setting the temperature

#### Setting the temperature

- Different temperatures can be set for the driver's and front-passenger sides.
- Turn the SmartKey to position  in the ignition lock (► page 126).
  - Turn control  or  counter-clockwise or clockwise.  
Only change the temperature setting in small increments. Start at 72 °F (22 °C).
  - i** If you turn controls  and  counter-clockwise to the lowest temperature setting, air-recirculation mode may switch on automatically, depending on the outside temperature.







## Setting the air distribution

### Activating/deactivating

- ▶ Turn the SmartKey to position **2** in the ignition lock (▷ page 126).
- ▶ Press the  button repeatedly until the desired symbol appears in the display.

### Air distribution settings



The following air distribution settings can be selected:

-  Directs air through the center and side air vents
-  Directs air through the footwell air vents
-  Directs air through the center, side and footwell vents
-  Directs air through the defroster vents
-  Directs the airflow through the defroster, center and side air vents (Canada only)
-  Directs air through the defroster and footwell vents
-  Directs the airflow through the defroster vents, the center and side air vents as well as the footwell air vents (Canada only)



- i** Regardless of the air distribution setting, airflow is always directed through the side air vents. The side air vents can only be closed when the adjuster in the side air vent is turned clockwise.

## Setting the airflow



### Setting the airflow

- ▶ Turn the SmartKey to position **2** in the ignition lock (▷ page 126).
- ▶ **To increase:** press the  button.
- ▶ **To reduce:** press the  button.

## Switching the ZONE function on/off

- ▶ **To switch on:** press the  button. The indicator lamp in the  button lights up. The temperature setting for the driver's

side is not adopted for the front-passenger side.

- ▶ **To switch off:** press the  button. The indicator lamp in the  button goes out. The temperature setting for the driver's side is adopted for the front-passenger side.



## Defrosting the windshield



### General notes

You can use this function to defrost the windshield or to defrost the inside of the windshield and the side windows.

Switch off the "Windshield defrosting" function as soon as the windshield is clear again.

### Switching the "windshield defrosting" function on or off

- ▶ Turn the SmartKey to position **2** in the ignition lock (▷ page 126).
- ▶ **To switch on:** press the  button. The indicator lamp in the  button lights up. The climate control system switches to the following functions:
  - high airflow
  - high temperature
  - air distribution to the windshield and front side windows
  - air-recirculation mode off

- ▶ **To switch off:** press the  button. The indicator lamp in the  button goes out. The previously selected settings are restored. Air-recirculation mode remains deactivated.

or

- ▶ Press the **AUTO** button. The indicator lamp in the  button goes out. Airflow and air distribution are set to automatic mode.

or

- ▶ Turn temperature control **1** or **8** counter-clockwise or clockwise (▷ page 116).



or

- ▶ Press the  or  button.

### MAX COOL maximum cooling

The MAX COOL function is only available in vehicles for the USA.

MAX COOL is only operational when the engine is running.



- ▶ **To activate:** press the  button.  
The indicator lamp in the button lights up.
- ▶ **To deactivate:** press the  button.  
The indicator lamp in the button goes out.  
The previously selected settings are restored.

When you activate MAX COOL, climate control switches to the following functions:

- maximum cooling
- maximum airflow
- air-recirculation mode on

### Removing condensation from the windows



#### Windows fogged up on the inside

- ▶ Activate the  cooling with air dehumidification function.
  - ▶ Activate the  mode button.
  - ▶ If the windows continue to fog up, activate the  "Windshield defrosting" function.
- i** You should only select this setting until the windshield is clear again.

#### Problems with the rear window defroster

Problem	Possible causes/consequences and ▶ Solutions
The rear window defroster has deactivated prematurely or cannot be activated.	<p>The on-board voltage is too low because too many electrical consumers are switched on.</p> <ul style="list-style-type: none"> <li>▶ Switch off any consumers that are not required, e.g. reading lamps, interior lighting or the seat heating.</li> </ul> <p>When the battery is sufficiently charged, the rear window defroster can be activated again.</p>

#### Windows fogged up on the outside

- ▶ Activate the windshield wipers.
  - ▶ Press the  button repeatedly until the  or  symbol appears in the display.
- i** You should only select this setting until the windshield is clear again.



#### Rear window defroster

##### General notes

The rear window defroster has a high current draw. You should therefore switch it off as soon as the rear window is clear. Otherwise, the rear window defroster switches off automatically after several minutes.

If the battery voltage is too low, the rear window defroster may switch off.

##### Activating/deactivating

- ▶ Turn the SmartKey to position  in the ignition lock (▶ page 126).
- ▶ Press the  button.  
The indicator lamp in the  button lights up or goes out.



### Switching air-recirculation mode on/off

#### General notes



If you switch on air-recirculation mode, the windows can fog up more quickly, in particular at low temperatures. Only use air-recirculation mode briefly to prevent the windows from fogging up.

#### Activating/deactivating

► Turn the SmartKey to position **2** in the ignition lock (▷ page 126).

► **To activate:** press the  button. The indicator lamp in the  button lights up.

**i** Air-recirculation mode is automatically activated at high levels of pollution or at high outside temperatures. When air-recirculation mode is activated automatically, the indicator lamp in the  button is not lit. Outside air is added after about 30 minutes.

► **To deactivate:** press the  button. The indicator lamp in the  button goes out.

**i** Air-recirculation mode deactivates automatically:

- after approximately five minutes at outside temperatures below approximately 41 °F (5 °C)
- after approximately five minutes if cooling with air dehumidification is deactivated
- after approximately 30 minutes at outside temperatures above approximately 41 °F (5 °C) if the "Cooling with air dehumidification" function is activated

### Switching the residual heat on or off



#### General notes

The residual heat function is only available on vehicles for Canada.

It is possible to make use of the residual heat of the engine to continue heating the stationary vehicle for up to 30 minutes after the engine has been switched off. The heating time depends on the set interior temperature.



### Activating/deactivating

► Turn the SmartKey to position **0** in the ignition lock or remove it (▷ page 126).

► **To activate:** press the  button. The indicator lamp in the  button lights up.

**i** The blower will run at a low speed regardless of the airflow setting.

**i** If you activate the residual heat function at high temperatures, only the ventilation will be activated. The blower runs at medium speed.

► **To deactivate:** press the  button. The indicator lamp in the  button goes out.

Residual heat is deactivated automatically:

- after approximately 30 minutes
- when the ignition is switched on
- if the battery voltage drops

### Setting the air vents

#### Important safety notes

##### WARNING

Very hot or very cold air can flow from the air vents. This could result in burns or frostbite in the immediate vicinity of the air vents. There is a risk of injury.

Make sure that all vehicle occupants always maintain a sufficient distance to the air outlets. If necessary, redirect the airflow to another area of the vehicle interior.

##### WARNING

When AIRSCARF is switched on, very hot air can flow from the vents in the head restraints. This could result in burns in the immediate vicinity of the air vents. There is a risk of injury.

Reduce the heater output before it becomes too hot.

In order to ensure the direct flow of fresh air through the air vents into the vehicle interior, please observe the following notes:

- keep the air inlet grille on the hood and in the engine compartment on the front-passenger side free of blockages, such as ice, snow or leaves.
- never cover the air vents or air intake grilles in the vehicle interior.

- i** You can move the adjusters for the air vents vertically or horizontally to set the direction of the airflow.
- i** For optimal climate control in the vehicle, open the air vents completely and set the adjusters to the central position.

### Setting the center air vents

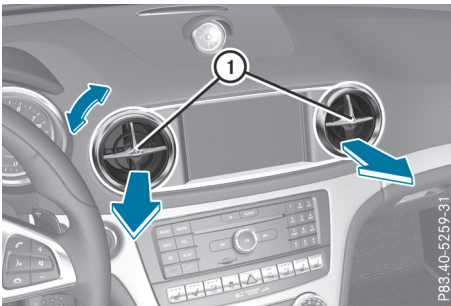

- **To open the center air vents:** turn the adjuster in one of center air vents ① counter-clockwise.
- **To close the center air vents:** turn the adjuster in one of center air vents ① clockwise until it engages.

### Setting the side air vents

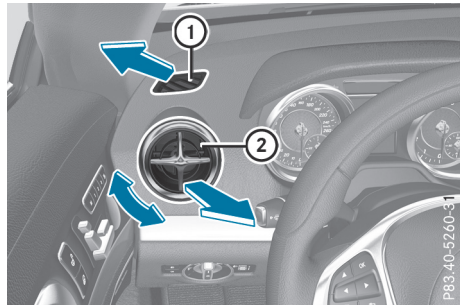

- ① Side window defroster vent
- ② Side air vent

- **To open a side air vent:** turn the adjuster in the side air vent ② to the left.
- **To close a side air vent:** turn the adjuster in the side air vent ② to the right until it engages.

### Setting the glove compartment air vent

- !** Close the air vent when heating the vehicle.

At high outside temperatures, open the air vent and activate the "cooling with air dehumidification" function. Otherwise, temperature-sensitive items stored in the glove box could be damaged.

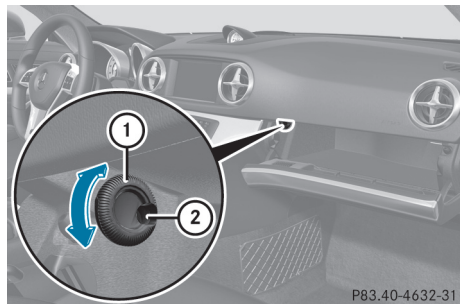

- ① Air vent control
- ② Air vent

When the climate control system is activated, the glove box can be ventilated, for instance to cool its contents. The level of airflow depends on the airflow and air distribution settings.

- **To open or close:** turn thumbwheel ① to the right or left.

### Setting the blower output of the AIRSCARF vents

#### **WARNING**

When AIRSCARF is switched on, very hot air can flow from the vents in the head restraints. This could result in burns in the immediate vicinity of the air vents. There is a risk of injury.

Reduce the heater output before it becomes too hot.

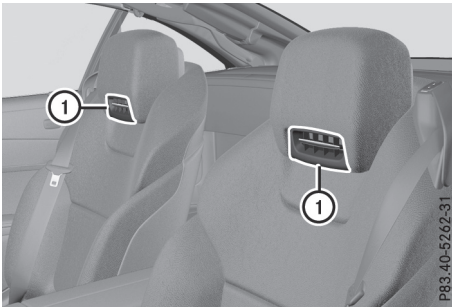

You can adjust the blower output of AIRSCARF vents ① using the AIRSCARF button (► page 102).



## Notes on breaking-in a new vehicle

### Important safety notes

The sensor system of some driving and driving safety systems adjusts automatically while a certain distance is being driven after the vehicle has been delivered or after repairs. Full system effectiveness is not reached until the end of this teach-in procedure.

New and replaced brake pads and discs only reach their optimum braking effect after several hundred kilometers of driving. Compensate for this by applying greater force to the brake pedal.

### The first 1000 miles (1500 km)

The more you look after the engine when it is new, the more satisfied you will be with its performance in the future.

- You should therefore drive at varying vehicle and engine speeds for the first 1,000 miles (1,500 km).
- Avoid heavy loads, e.g. driving at full throttle, during this period.
- Change gear in good time, before the tachometer needle is  $\frac{2}{3}$  of the way to the red area of the tachometer.
- Do not manually shift to a lower gear to brake the vehicle.
- Try to avoid depressing the accelerator pedal beyond the point of resistance (kick-down).

Additional breaking-in notes for Mercedes-AMG vehicles:

- Do not drive faster than 85 mph (140 km/h) for the first 1,000 miles (1,500 km).
- Only allow the engine to reach a maximum engine speed of 4,500 rpm briefly.
- Ideally, for the first 1000 miles (1500 km), drive in program **C**.
- Change gear in good time.

After 1000 miles (1500 km), you can increase the engine speed gradually and accelerate the vehicle to full speed.

You should also observe these notes on breaking in if the engine or parts of the drive train on your vehicle have been replaced.

Always observe the maximum permissible speed.

## Self-locking rear axle differential (Mercedes-AMG vehicles)

Your vehicle is equipped with a self-locking differential on the rear axle.

Change the oil to improve protection of the rear axle differential:

- after a breaking-in period of 2000 miles (USA)
- after a breaking-in period of 3000 km (Canada)
- every 30,000 miles or 3 years (USA)
- every 60,000 km or 4 years (Canada)

These oil changes prolong the service life of the differential. Have the oil change carried out at a qualified specialist workshop.

## Driving

### Important safety notes

#### WARNING

Objects in the driver's footwell may restrict the clearance around the pedals or block a depressed pedal. This jeopardizes the operating and road safety of the vehicle. There is a risk of an accident.

Stow all objects securely in the vehicle so that they do not get into the driver's footwell. When using floor mats or carpets, make sure that they are properly secured so that they do not slip or obstruct the pedals. Do not place several floor mats or carpets on top of one another.

#### WARNING

Unsuitable footwear can hinder correct usage of the pedals, e.g.:

- shoes with thick soles
- shoes with high heels
- slippers

There is a risk of an accident.

Wear suitable footwear to ensure correct usage of the pedals.

**⚠ WARNING**

If you switch off the ignition while driving, safety-relevant functions are only available with limitations, or not at all. This could affect, for example, the power steering and the brake boosting effect. You will require considerably more effort to steer and brake. There is a risk of an accident.

Do not switch off the ignition while driving.

**⚠ WARNING**

If the parking brake has not been fully released when driving, the parking brake can:

- overheat and cause a fire
- lose its hold function.

There is a risk of fire and an accident.

Release the parking brake fully before driving off.

**!** Do not warm up the engine while stationary. Pull away immediately. Avoid high engine speeds and full throttle until the engine has reached its operating temperature.

In vehicles with automatic transmission, engage positions P and R only when the vehicle is stationary.

Where possible, avoid spinning the drive wheels when pulling away on slippery roads. You could otherwise damage the drive train.

**!** **Mercedes-AMG vehicles:** at low engine oil temperatures below 68 °F (+20 °C), the maximum engine speed is restricted in order to protect the engine. To protect the engine and maintain smooth engine operation, avoid driving at full throttle when the engine is cold.

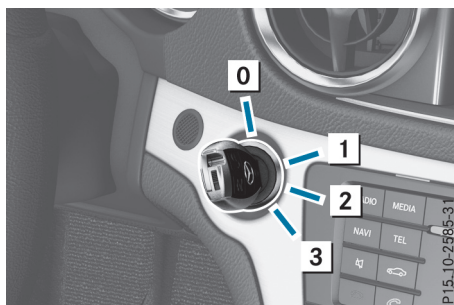
**Key positions****SmartKey**

- 0** To remove the SmartKey
- 1** Power supply for some consumers, such as the windshield wipers
- 2** Ignition (power supply for all consumers) and drive position
- 3** To start the engine

**i** The SmartKey can be turned in the ignition lock even if it is not the correct SmartKey for the vehicle. The ignition is not switched on. The engine cannot be started.

**KEYLESS-GO****General notes**

Vehicles with KEYLESS-GO are equipped with a SmartKey featuring an integrated KEYLESS-GO start function and a detachable Start/Stop button.

The Start/Stop button must be inserted in the ignition lock and the SmartKey must be in the vehicle.

When you insert the Start/Stop button into the ignition lock, the system needs approximately two seconds recognition time. You can then use the Start/Stop button.

Pressing the Start/Stop button several times in succession corresponds to the different key positions in the ignition lock. This is only the case if you are not depressing the brake pedal.

If you depress the brake pedal and press the Start/Stop button, the engine starts immediately.

A check which periodically establishes a radio connection between the vehicle and the SmartKey determines whether a valid Smart-

Key is in the vehicle. This occurs, for example, when starting the engine.

To start the vehicle without actively using the SmartKey:

- the Start/Stop button must be inserted in the ignition lock.
- the SmartKey must be in the vehicle.
- the vehicle must not be locked with the SmartKey or KEYLESS-GO (▷ page 74).

Do not keep the SmartKey:

- with electronic devices, e.g. a mobile phone or another SmartKey.
- with metallic objects, e.g. coins or metal foil.
- inside metallic objects, e.g. a metal case.

This can impair the functionality of the KEYLESS-GO key.

If you lock the vehicle with the SmartKey's remote control or with KEYLESS-GO, after a short time:

- you will not be able to switch on the ignition with the Start/Stop button.
- you will not be able to start the engine with the Start/Stop button until the vehicle is unlocked again.

The engine can be switched off while the vehicle is in motion by pressing and holding the Start/Stop button for three seconds. This function operates independently of the ECO start/stop automatic engine switch-off function.

### Key positions with KEYLESS-GO

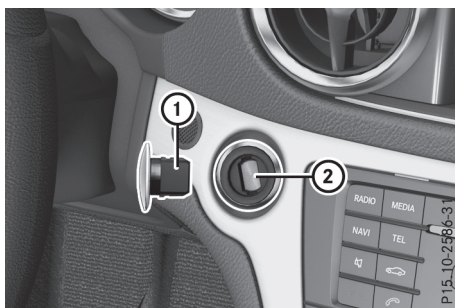

- ① Start/Stop button
- ② Ignition lock

As soon as the ignition is switched on, all the indicator lamps in the instrument cluster light up. Further information on situations where an indicator lamp either fails to go out after start-

ing the engine or lights up while driving (▷ page 235).

If Start/Stop button ① has not yet been pressed, this corresponds to the key being removed from the ignition.

► **To switch on the power supply:** press Start/Stop button ① once.

The power supply is switched on. You can now activate the windshield wipers, for example.

The power supply is switched off again if:

- the driver's door is opened and
- you press Start/Stop button ① twice when in this position

► **To switch on the ignition:** press Start/Stop button ① twice.

The ignition is switched on.

If you press Start/Stop button ① once when in this position, the ignition is switched off again.

### Removing the Start/Stop button

You can remove the Start/Stop button from the ignition lock and start the vehicle as normal using the SmartKey.

► Remove Start/Stop button ① from ignition lock ②.

You do not have to remove the Start/Stop button from the ignition lock when you leave the vehicle. You should, however, always take the SmartKey with you when leaving the vehicle. As long as the SmartKey is in the vehicle:

- the vehicle can be started using the Start/Stop button
- the electrically powered equipment can be operated

### Starting the engine

### Important safety notes

#### ⚠ WARNING

If children are left unsupervised in the vehicle, they could:

- operate the vehicle's equipment

Additionally, children could set the vehicle in motion if, for example, they:

- release the parking brake
- shift the automatic transmission out of park position **P**
- start the engine

There is a risk of an accident and injury.

Never leave children or animals unattended in the vehicle.

When leaving the vehicle, always take the SmartKey with you and lock the vehicle. This also applies for the Digital Vehicle Key if the "Digital Vehicle Key" function is activated via Mercedes me connect.

### DANGER

Combustion engines emit poisonous exhaust gases such as carbon monoxide. Inhaling these exhaust gases is hazardous to health and can result in poisoning. There is a risk of fatal injury. Therefore, never leave the engine running an enclosed space without adequate ventilation.

### WARNING

Flammable materials introduced through environmental influence or by animals can ignite if in contact with the exhaust system or parts of the engine that heat up. There is a risk of fire.

Carry out regular checks to make sure that there are no flammable foreign materials in the engine compartment or in the exhaust system.

The catalytic converter is preheated for up to 30 seconds after a cold start. The sound of the engine may change during this time.

## Automatic transmission

- ▶ Depress the brake pedal and keep it depressed.
- ▶ Shift the transmission to position **P**. Transmission position display **P** is shown in the multifunction display.

**i** You can start the engine in transmission position **P** and **N**.

## Starting procedure with the SmartKey

To start the engine using the SmartKey instead of KEYLESS-GO, pull the Start/Stop button out of the ignition lock.

- ▶ Turn the SmartKey to position **3** (▷ page 126) in the ignition lock and release it as soon as the engine is running.

## Using KEYLESS-GO to start the engine

The Start/Stop button can be used to start the vehicle manually without inserting the SmartKey into the ignition lock. The Start/Stop button must be inserted in the ignition lock and the SmartKey must be in the vehicle. This mode for starting the engine operates independently of the ECO start/stop automatic engine start function.

- ▶ Depress the brake pedal and keep it depressed.
- ▶ Press the Start/Stop button once (▷ page 126). The engine starts.

## Pulling away

### General notes

#### WARNING

If the engine speed is above the idling speed and you engage transmission position **D** or **R**, the vehicle could pull away suddenly. There is a risk of an accident.

When engaging transmission position **D** or **R**, always firmly depress the brake pedal and do not simultaneously accelerate.

Depress the accelerator carefully when pulling away.

The vehicle locks centrally once you have pulled away. The locking knobs in the doors drop down.

You can open the doors from the inside at any time.

You can also deactivate the automatic locking feature (▷ page 201).

It is only possible to shift the transmission from position **P** to the desired position if you depress the brake pedal. Only then is the shift lock released.

- i** Upshifts take place at higher engine speeds after a cold start. This helps the catalytic converter to reach its operating temperature more quickly.

Information on the automatic release of the electric parking brake (> page 148).

## Hill start assist

Hill start assist helps you when pulling away forward or in reverse on an uphill gradient. It holds the vehicle for a short time after you have removed your foot from the brake pedal. This gives you enough time to move your foot from the brake pedal to the accelerator pedal and to depress it before the vehicle begins to roll.

### WARNING

After a short time, hill start assist will no longer brake your vehicle and it could roll away. There is a risk of an accident and injury.

Therefore, quickly move your foot from the brake pedal to the accelerator pedal. Never leave the vehicle when it is held by hill start assist.

Hill start assist is not active if:

- you are pulling away on a level road or on a downhill gradient
- the transmission is in position **N**
- the electric parking brake is applied
- ESP<sup>®</sup> is malfunctioning

## ECO start/stop function

### Introduction

The ECO start/stop function switches the engine off automatically if the vehicle is stopped under certain conditions.

The engine starts automatically when the driver wants to pull away again. The ECO start/stop function thereby helps you to reduce the fuel consumption and emissions of your vehicle.

## Important safety notes

### WARNING

If the engine is switched off automatically and you exit the vehicle, the engine is restarted automatically. The vehicle may begin moving. There is a risk of accident and injury.

If you wish to exit the vehicle, always turn off the ignition and secure the vehicle against rolling away.

## General notes

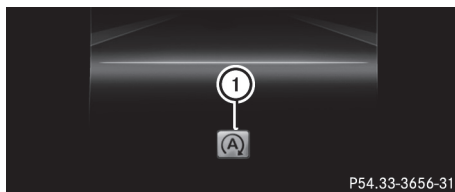

### **1** ECO start/stop display

The ECO start/stop function is activated whenever you switch on the engine using the SmartKey or the Start/Stop button.

If the engine has been switched off automatically by the ECO start/stop function, the **(A)** ECO symbol is shown in the multifunction display.

**Mercedes-AMG vehicles:** the ECO start/stop function is only available in drive program **C**.

## Automatic engine switch-off

If the vehicle is braked to a standstill with the transmission in **D** or **N**, the ECO start/stop function switches off the engine automatically. The ECO start/stop function is operational when:

- the indicator lamp in the ECO button is lit green
- the outside temperature is within the range that is suitable for the system
- the engine is at normal operating temperature
- the set temperature for the vehicle interior has been reached
- the battery is sufficiently charged

- the system detects that the windshield is not fogged up when the air-conditioning system is switched on
- the hood is closed
- the driver's door is closed and the driver's seat belt is fastened

All of the vehicle's systems remain active when the engine is stopped automatically.

**All vehicles (except Mercedes-AMG vehicles):** automatic engine switch-off can take place a maximum of four times in a row (initial stop, then three subsequent stops).

**Mercedes-AMG vehicles:** the number of consecutive automatic engine switch-offs is unlimited.

The HOLD function can be activated if the engine has been switched off automatically. It is then not necessary to continue applying the brakes during the automatic stop phase. When you depress the accelerator pedal, the engine starts automatically and the braking effect of the HOLD function is deactivated.

### Automatic engine start

The engine starts automatically if:

- you switch off the ECO start/stop function by pressing the ECO button
  - in transmission position **D** or **N**, the brake pedal is released and the HOLD function is not active
  - you depress the accelerator pedal
  - you engage reverse gear **R**
  - you move the transmission out of position **P**
  - you switch to drive program **S+**
  - you switch to drive program **S** or **M** (Mercedes-AMG vehicles)
  - you unfasten your seat belt or open the driver's door
  - the vehicle starts to roll
  - the brake system requires this
  - the temperature in the vehicle interior deviates from the set range
  - the system detects moisture on the windshield when the air-conditioning system is switched on
  - the battery's condition of charge is too low
- Shifting the transmission to position **P** does not start the engine.

### Deactivating or activating the ECO start/stop function

#### All vehicles (except Mercedes-AMG vehicles)



- ▶ **To deactivate:** press ECO button ①. Indicator lamp ② goes out.
- ▶ **To activate:** press ECO button ①. Indicator lamp ② lights up.

If indicator lamp ② is off, the ECO start/stop function has been deactivated manually or as the result of a malfunction. The engine will then not be switched off automatically when the vehicle stops.

#### Mercedes-AMG vehicles



- ▶ **To deactivate:** in drive program **C**, press ECO button ①.
- or
- ▶ Switch to drive program **S**, **S+** or **M** (▷ page 133). Indicator lamp ② goes out.
  - ▶ **To activate:** press ECO button ①. Indicator lamp ② lights up.

If drive program **S**, **S+** or **M** is active, the automatic transmission switches to drive program **C**.

If indicator lamp ② is off, the ECO start/stop function has been deactivated manually or as

the result of a malfunction. The engine will then not be switched off automatically when the vehicle stops.

Problems with the engine	
Problem	Possible causes/consequences and ► Solutions
The engine does not start.	<p>The HOLD function or Active Distance Assist DISTRONIC is activated.</p> <ul style="list-style-type: none"> <li>► Deactivate the HOLD function (▷ page 165) or Active Distance Assist DISTRONIC (▷ page 161).</li> <li>► Try to start the engine again.</li> </ul>
The engine does not start. The starter motor can be heard.	<ul style="list-style-type: none"> <li>• There is a malfunction in the engine electronics.</li> <li>• There is a malfunction in the fuel supply.</li> </ul> <p>Before attempting to start the engine again:</p> <ul style="list-style-type: none"> <li>► Turn the SmartKey back to position <b>0</b> in the ignition lock.</li> </ul> <p>or</p> <ul style="list-style-type: none"> <li>► Press the Start/Stop button repeatedly until all indicator lamps in the instrument cluster go out.</li> <li>► Try to start the engine again (▷ page 127). Avoid excessively long and frequent attempts to start the engine as these will drain the battery.</li> </ul> <p>If the engine does not start after several attempts:</p> <ul style="list-style-type: none"> <li>► Consult a qualified specialist workshop.</li> </ul>
The engine does not start. You cannot hear the starter motor.	<p>The on-board voltage is too low because the battery is too weak or discharged.</p> <ul style="list-style-type: none"> <li>► Jump-start the vehicle (▷ page 285).</li> </ul> <p>If the engine does not start despite attempts to jump-start it:</p> <ul style="list-style-type: none"> <li>► Consult a qualified specialist workshop.</li> </ul> <p>The starter motor was exposed to a thermal load that was too high.</p> <ul style="list-style-type: none"> <li>► Allow the starter motor to cool down for approximately two minutes.</li> <li>► Try to start the engine again.</li> </ul> <p>If the engine still does not start:</p> <ul style="list-style-type: none"> <li>► Consult a qualified specialist workshop.</li> </ul>



Problem	Possible causes/consequences and ► Solutions
The engine is not running smoothly and is misfiring.	<p>There is a malfunction in the engine electronics or in a mechanical component of the engine management system.</p> <ul style="list-style-type: none"> <li>► Only depress the accelerator pedal slightly. Otherwise, non-combusted fuel may get into the catalytic converter and damage it.</li> <li>► Have the cause rectified immediately at a qualified specialist workshop.</li> </ul>
The coolant temperature display shows a value above 248 °F (120 °C). The coolant warning lamp may also be on and a warning tone may sound.	<p>The coolant level is too low. The coolant is too hot and the engine is no longer being cooled sufficiently.</p> <ul style="list-style-type: none"> <li>► Stop as soon as possible and allow the engine and the coolant to cool down.</li> <li>► Check the coolant level (► page 267). Observe the warning notes as you do so and add coolant if necessary.</li> </ul>
	<p>If the coolant level is correct, the engine radiator fan may be faulty. The coolant is too hot and the engine is no longer being cooled sufficiently.</p> <ul style="list-style-type: none"> <li>► At coolant temperatures below 248 °F (120 °C), drive to the nearest qualified specialist workshop.</li> <li>► Avoid heavy loads on the engine as you do so, e.g. driving in mountainous terrain and stop-and-go traffic.</li> </ul>

### Notes on towing vehicles

The vehicle is not suitable for attaching tow bar systems, such as those used for flat towing or dinghy towing.

Attaching or using tow bar systems may result in damage to the vehicle.

When towing a vehicle with tow bar systems, safe driving characteristics cannot be guaranteed for the towing vehicle or the towed vehicle.

The vehicle/vehicle combination may swerve.

Observe the permissible towing methods (► page 289) and the notes on towing with both axles on the ground (► page 289).

### DYNAMIC SELECT button (all vehicles except Mercedes-AMG vehicles)

Use the DYNAMIC SELECT button to change the drive program. Depending on the drive program selected the following vehicle characteristics will change:

- the drive (engine and transmission management)
- the suspension
- the steering
- the curve tilting function (vehicles with Active Body Control)
- the control thresholds of ESP®

Each time you start the engine with the Smart-Key or the Start/Stop button, drive program **C** is activated. Further information about starting the engine (► page 127).

Each time you start the engine with the Smart-Key, drive program **C** is activated. Further information about starting the engine (► page 127).



▶ Press DYNAMIC SELECT button ① as many times as necessary until the desired drive program is selected.

The selected drive program appears in the multifunction display. After a short period of time, the display goes out and the symbol for the selected drive program appears.

In addition, the current drive program settings are displayed briefly in the multimedia system display.

**i** In a few countries, the ECO start/stop function is deactivated at the factory due to the available fuel grade. In this case, the ECO start/stop function is not available in any drive program, regardless of the display in the multimedia system display.

**Available drive programs:**

<b>C</b> Comfort	Comfortable and economical driving characteristics
<b>S</b> Sport	Sporty driving characteristics
<b>S+</b> Sport Plus	Particularly sporty driving characteristics
<b>I</b> Individual	Individual settings
<b>E</b> Economy (vehicles with adjustable damping)	Particularly economical driving characteristics
<b>CV</b> CURVE (vehicles with Active Body Control)	Particularly economical driving characteristics with cornering function

Additional information for drive programs (▶ page 138).

**DYNAMIC SELECT controller (Mercedes-AMG vehicles)**

**General information**

Select the drive program using the DYNAMIC SELECT controller.

**Available drive programs:**

<b>I</b> Individual	Individual settings
<b>C</b> Comfort	Comfort-oriented, optimum-economy engine and transmission settings
<b>S</b> Sport	Sporty engine and transmission settings
<b>S+</b> Sport Plus	Particularly sporty transmission settings
<b>Race</b>	Maximum sportiness and engine and transmission settings suitable for the racetrack

Depending on the drive program selected the following vehicle characteristics will change:

- the drive (engine management)
- the transmission management
- ESP®
- the suspension
- the steering
- the availability of the ECO start/stop function
- the driver assistance systems
- the availability of gliding mode

Further information for automatic drive program characteristics (▶ page 138).

Additionally, in drive program I you can configure the respective vehicle characteristics using the multimedia system. You can find information about this in the Digital Operator's Manual.

Each time you start the engine with the Smart-Key or the Start/Stop button, drive program C is activated. For further information about starting the engine, see (▶ page 127).

### Selecting the drive program



- ▶ Turn DYNAMIC SELECT controller ① as many times as necessary until the desired drive program is selected. The symbol of the selected drive program is shown in the multifunction display.

In addition, the current drive program settings are displayed briefly in the multimedia system display.

The drive program indicator on DYNAMIC SELECT controller ① lights up in red.

Additional information for drive programs (▷ page 138).

### Additional settings



- ① ECO start/stop function (▷ page 129)
- ② ESP® (▷ page 65)
- ③ Suspension (▷ page 171)
- ④ Permanent activation of manual gearshifting (▷ page 141)

When you press buttons ① - ④ the corresponding setting is selected. The DYNAMIC SELECT controller setting is overwritten.

These settings will also be maintained if you switch to drive program **RACE**, **S+**, **S** or **C** with the DYNAMIC SELECT controller.

If you switch to drive program **I**, all stored characteristics will be accepted. This is also the case if you have previously pressed buttons ① - ④.

## Automatic transmission

### Important safety notes

#### ⚠ WARNING

If the engine speed is above the idling speed and you engage transmission position **D** or **R**, the vehicle could pull away suddenly. There is a risk of an accident.

When engaging transmission position **D** or **R**, always firmly depress the brake pedal and do not simultaneously accelerate.

#### ⚠ WARNING

The automatic transmission switches to neutral position **N** when you switch off the engine. The vehicle may roll away. There is a risk of an accident.

After switching off the engine, always switch to parking position **P**. Prevent the parked vehicle from rolling away by applying the parking brake.

### Selector lever

### Overview of transmission positions

#### All vehicles (except Mercedes-AMG vehicles)

- ⚠ If the engine speed is too high or the vehicle is in motion, do not shift the automatic transmission directly from **D** to **R**, from **R** to **D** or directly to **P**.

Do not open the driver's door while the vehicle is in motion. At low speeds in transmission position **D** or **R**, otherwise park position **P** is engaged automatically.

The transmission could be damaged.

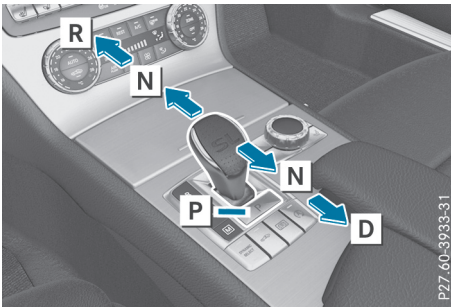

- P** Park position
- R** Reverse gear
- N** Neutral
- D** Drive

The selector lever always returns to its original position. The current transmission position **P**, **R**, **N** or **D** is shown in the transmission position display in the multifunction display.

### Mercedes-AMG vehicles

**!** If the engine speed is too high or the vehicle is in motion, do not shift the automatic transmission directly from **D** to **R**, from **R** to **D** or directly to **P**.

Do not open the driver's door while the vehicle is in motion. At low speeds in transmission position **D** or **R**, otherwise park position **P** is engaged automatically.

The transmission could be damaged.

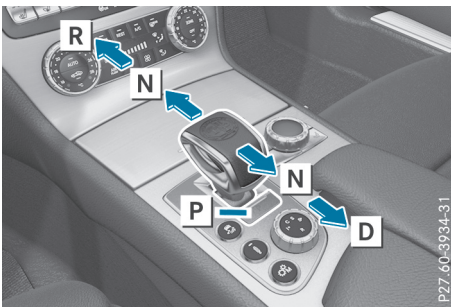

- P** Park position
- R** Reverse gear
- N** Neutral
- D** Drive

The selector lever always returns to its original position. The current transmission position **P**, **R**, **N** or **D** is shown in the transmission position display in the multifunction display.

### Transmission position and drive program display

All vehicles (except Mercedes-AMG vehicles)

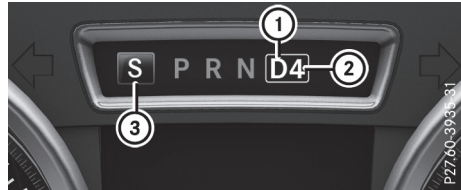

- ① Transmission position
- ② Gear
- ③ Drive program

The current transmission position and drive program appear in the multifunction display.

### Mercedes-AMG vehicles

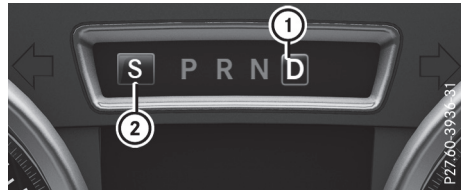

- ① Transmission position
- ② Drive program

The current transmission position and drive program appear in the multifunction display. In addition to drive program ② being shown in the multifunction display, the currently selected drive program is indicated in red on the DYNAMIC SELECT controller (▷ page 133).

## Engaging park position P

### All vehicles (except Mercedes-AMG vehicles)



- ▶ When the vehicle is stationary, depress the brake pedal.
- ▶ Press button ①.

### Mercedes-AMG vehicles



- ▶ When the vehicle is stationary, depress the brake pedal.
- ▶ Press button ①.

## Engaging park position P automatically

Park position **P** is automatically engaged if:

- you switch off the engine using the SmartKey and remove the SmartKey
- you switch off the engine using the SmartKey or using the Start/Stop button and open the driver's door or front-passenger door
- you open the driver's door when the vehicle is stationary or when driving at a very low speed and the transmission is in position **D** or **R**

Under certain conditions, the automatic transmission shifts automatically to transmission position **P** if the HOLD function or Active Distance Assist DISTRONIC is activated. Observe the information on the HOLD function (▷ page 165) and on Active Distance Assist DISTRONIC (▷ page 159).

## Engaging reverse gear R

! Only move the automatic transmission to **R** when the vehicle is stationary.

- ▶ Depress the brake and keep it pressed.
- ▶ Push the selector lever forwards past the first point of resistance.

The ECO start/stop function is not available when reverse gear is engaged. Further information on the ECO start/stop function (▷ page 129).

## Shifting to neutral N

### ⚠ WARNING

If children are left unsupervised in the vehicle, they could:

- operate the vehicle's equipment
- Additionally, children could set the vehicle in motion if, for example, they:
- release the parking brake
  - shift the automatic transmission out of park position **P**
  - start the engine

There is a risk of an accident and injury.

Never leave children or animals unattended in the vehicle.

When leaving the vehicle, always take the SmartKey with you and lock the vehicle. This also applies for the Digital Vehicle Key if the "Digital Vehicle Key" function is activated via Mercedes me connect.

- ▶ When the vehicle is stationary, depress the brake pedal.
- ▶ Push the selector lever forwards or back to the first point of resistance.

If you switch the engine off with the transmission in position **R** or **D**, the automatic transmission shifts to **N** automatically.

**With the SmartKey:** if you then open the driver's door or the front-passenger door or remove the SmartKey from the ignition, the automatic transmission shifts to **[P]** automatically.

**With KEYLESS-GO:** if you then open the driver's or front-passenger door, the automatic transmission shifts to **[P]** automatically.

If you want the automatic transmission to remain in neutral **[N]**, e.g. when having the vehicle cleaned in an automatic car wash with a towing system:

- ▶ **Vehicles with KEYLESS-GO:** remove the Start/Stop button from the ignition lock.
- ▶ Insert the SmartKey into the ignition lock.
- ▶ **All vehicles:** switch the ignition on.
- ▶ Depress the brake pedal and keep it depressed.
- ▶ Shift to neutral **[N]**.
- ▶ Release the brake pedal.
- ▶ Release the electric parking brake.
- ▶ Switch off the ignition and leave the SmartKey in the ignition lock.

### Engaging drive position D

- ▶ When the vehicle is stationary, depress the brake pedal.
- ▶ Push the selector lever back past the first point of resistance.

## Transmission positions

**[P]**

### Park position

This prevents the vehicle from rolling away when stopped.

Only shift the transmission into position **[P]** (> page 134) when the vehicle is stationary. The parking lock should not be used as a brake when parking. Always apply the electronic parking brake in addition to the parking lock in order to secure the vehicle.

If the SmartKey is removed from the ignition lock, the transmission is locked.

The automatic transmission shifts to **[P]** automatically:

- when the SmartKey is removed from the ignition lock
- when the engine is switched off with the transmission in position **[R]** or **[D]** and one of the doors is opened

In the event of a malfunction of the vehicle's electronics, the transmission may lock in position **[P]**. Have the vehicle electronics checked immediately at a qualified specialist workshop.

**[R]**

### Reverse gear

Only shift the transmission into position **[R]** when the vehicle is stationary.



**N****Neutral**

Do not shift the transmission to **N** while driving. The automatic transmission could otherwise be damaged.

No power is transmitted from the engine to the drive wheels.

Releasing the brake pedal will allow you to move the vehicle freely, e.g. to push it or tow it.

If ESP® is deactivated or faulty: shift the transmission to position **N** if the vehicle is in danger of skidding, e.g. on icy roads.

**!** Coasting in neutral **N** may cause damage to the drive train.

**D****Drive**

The automatic transmission changes gear automatically. All forward gears are available.

**Driving tips****Changing gear**

The automatic transmission shifts through the individual gears automatically when it is in transmission position **D**. This automatic gear shifting behavior is determined by:

- the selected drive program
- the position of the accelerator pedal
- the road speed

**Accelerator pedal position**

Your style of driving influences how the automatic transmission shifts gear:

- little throttle: early upshifts
- more throttle: late upshifts

**Kickdown**

Use kickdown for maximum acceleration.

- ▶ Depress the accelerator pedal beyond the pressure point.  
The automatic transmission shifts to a lower gear depending on the engine speed.
- ▶ Ease off the accelerator pedal once the desired speed is reached.  
The automatic transmission shifts back up.

**Drive programs****All vehicles (except Mercedes-AMG vehicles)****Drive program C (Comfort)**

Drive program **C** is characterized by the following:

- the vehicle pulls away more gently in forward and reverse gears, unless the accelerator pedal is depressed fully.
- low fuel consumption resulting from the automatic transmission shifting up sooner.  
The vehicle is driven in the low engine speed range and the wheels are less likely to spin.
- the suspension exhibits comfortable damping settings.
- the steering exhibits comfortable steering characteristics.
- ESP® provides the optimum compromise between traction and stability. Further information about ESP® (> page 66).

**i** Select this drive program for difficult road conditions, e.g. snow and ice or wet road surfaces.

**Drive program S (Sport)**

Drive program **S** is characterized by the following:

- the vehicle exhibits sporty driving characteristics.
- the vehicle pulls away in first gear.
- the automatic transmission shifts up later.  
The fuel consumption possibly being higher as a result of the later automatic transmission shift points.
- the suspension exhibits firm damping settings.



- the steering exhibits sporty steering characteristics.
- ESP® provides the optimum compromise between traction and stability. Further information about ESP® (> page 66).

### Drive program S+ (Sport Plus)

Drive program **S+** is characterized by the following:

- the vehicle exhibits particularly sporty driving characteristics.
- the vehicle pulls away in first gear.
- the automatic transmission shifts up later. The fuel consumption possibly being higher as a result of the later automatic transmission shift points.
- the suspension exhibits particularly firm damping settings (vehicles with adaptive damping system).
- the suspension exhibits firm damping settings (vehicles with Active Body Control).
- the steering exhibits sporty steering characteristics.
- ESP® emphasizes the vehicle's own oversteering and understeering characteristics. This enables a more active driving style. This drive program requires increased driver interaction. Further information about ESP® (> page 66).

**i** Only select this drive program if the road conditions are good, e.g. the road is dry and the route ahead is clearly visible.

### Drive program I (Individual)

In drive program **I** the following properties of the drive program can be selected:

- the drive (engine and transmission management)
- the suspension
- the steering
- the control thresholds of ESP®

Information about configuring drive program **I** with the multimedia system can be found in the Digital Operator's Manual.

### Vehicles with adaptive damping system: drive program E (Economy)

Drive program **E** is characterized by the following:

- the vehicle exhibits comfortable, economical handling characteristics.
- the vehicle pulls away more gently in forward and reverse gears, unless the accelerator pedal is depressed fully.
- optimal fuel consumption resulting from the automatic transmission shifting up sooner. The vehicle is driven in the low engine speed range and the wheels are less likely to spin.
- the suspension exhibits comfortable damping settings.
- the steering exhibits comfortable steering characteristics.
- during deceleration, the engine is disconnected from the drive train. The vehicle uses kinetic energy and consumes less fuel (coasting mode).
- ESP® provides the optimum compromise between traction and stability. Further information about ESP® (> page 66).

### Vehicles with Active Body Control: CURVE drive program

The **CURVE** drive program is characterized by the following:

- increased driving comfort on bends.
- the vehicle tilts actively into the bend. Further information on the curve tilting function (> page 169).
- the vehicle exhibits comfortable, economical handling characteristics.
- the vehicle pulls away more gently in forward and reverse gears, unless the accelerator pedal is depressed fully.
- comfortable suspension setting.
- the steering exhibits comfortable steering characteristics.
- optimal fuel consumption resulting from the automatic transmission shifting up sooner.
- the automatic transmission shifting up sooner. This results in the vehicle being driven at lower engine speeds and the wheels being less likely to spin.
- during deceleration, the engine is disconnected from the drive train. The vehicle uses

kinetic energy and consumes less fuel (coasting mode).

- ESP® provides the optimum compromise between traction and stability. Further information about ESP® (▷ page 66).

## Mercedes-AMG vehicles

### RACE drive program

**i** The RACE drive program may not be used on normal roads. RACE must only be activated and used on dedicated race circuits, not on public roads.

The **RACE** drive program is characterized by the following:

- the vehicle exhibits driving characteristics suitable for the racetrack.
- all vehicle systems are set for maximum sportiness.
- the gearshift recommendation gives you information for slowly warming up the drive assemblies and for adopting a fuel-efficient driving style (▷ page 141). You can follow the gearshift recommendations at all times and shift gear accordingly using the steering wheel paddle shifters. On the basis of the gearshift recommendation, using the steering wheel paddle shifters, you can optimize the drive train and engine operating mode at any time.
- if you have selected a gear manually, this will be maintained until the vehicle speed increases or decreases dramatically.
- the vehicle pulls away in first gear.
- the automatic transmission shifts up later. The fuel consumption possibly being higher as a result of the later automatic transmission shift points.
- the suspension exhibits particularly firm damping settings.
- gliding mode is not available.
- the ECO start/stop function is not available.
- ESP® switches to SPORT handling mode. The **SPORT** SPORT handling mode warning lamp in the instrument cluster lights up. The **SPORT Handling Mode** message appears in the multifunction display. Observe the important safety notes for the SPORT handling mode (▷ page 68).
- ESP® only improves driving stability to a limited degree. The engine's torque is only

restricted to a limited degree and the drive wheels can spin. Further information about ESP® (▷ page 68).

### Drive program S+ (Sport Plus)

Drive program **S+** is characterized by the following:

- the vehicle exhibits particularly sporty driving characteristics.
- the vehicle pulls away in first gear.
- the automatic transmission shifts up later. The fuel consumption possibly being higher as a result of the later automatic transmission shift points.
- the suspension exhibits particularly firm damping settings.
- gliding mode is not available.
- the ECO start/stop function is not available.
- ESP® provides the optimum compromise between traction and stability. Further information about ESP® (▷ page 66).

### Drive program S (Sport)

Drive program **S** is characterized by the following:

- the vehicle exhibits sporty driving characteristics.
- the vehicle pulls away in first gear.
- the automatic transmission shifts up later. The fuel consumption possibly being higher as a result of the later automatic transmission shift points.
- the suspension exhibits particularly firm damping settings.
- gliding mode is not available.
- the ECO start/stop function is not available.
- ESP® provides the optimum compromise between traction and stability. Further information about ESP® (▷ page 66).

### Drive program C (Comfort)

Drive program **C** is characterized by the following:

- the vehicle delivers comfortable, economical handling characteristics.
- the vehicle pulls away more gently in forward and reverse gears, unless the accelerator pedal is depressed fully.
- the vehicle has improved driving stability, for example on slippery road surfaces.

- optimal fuel consumption resulting from the automatic transmission shifting up sooner. The vehicle is driven in the low engine speed range and the wheels are less likely to spin.
- gliding mode is available.
- the ECO start/stop function is available.
- ESP<sup>®</sup> provides the optimum compromise between traction and stability. Further information about ESP<sup>®</sup> (▷ page 66).

### Drive program I (Individual)

In drive program I the following properties of the drive program can be selected:

- the drive (engine management)
- the transmission management
- ESP<sup>®</sup>
- the suspension

Information about configuring drive program I with the multimedia system can be found in the Digital Operator's Manual.

- i** To permanently select the gears in drive program I using the steering wheel paddle shifters, select the **M** (manual) setting for the transmission.

## Manual gear shifting

### General notes

You can change gear yourself using the steering wheel paddle shifters. The transmission must be in position **D** to do this.

Depending on which steering wheel paddle shifter is pulled, the automatic transmission immediately shifts into the next gear down or up, if permitted.

To use manual shifting, you have two options:

- temporary setting
- permanent setting

If you activate manual gearshifting, the multi-function display will show the current gear instead of transmission position **D**.

If manual gearshifting is deactivated, the gears will be selected automatically.

### Temporary setting

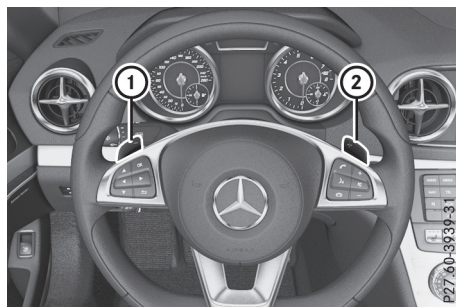

- ▶ **To activate:** shift the selector lever to **D**.
- ▶ Pull steering wheel paddle shifter ① or ②.

The temporary setting is active for a certain amount of time. Under certain conditions, the minimum amount of time is extended, e.g. in the case of lateral acceleration, during overrun mode or when driving on steep terrain.

- ▶ **To deactivate:** pull steering wheel paddle shifter ② and hold it in place.

or

- ▶ Use the lever to switch the transmission position.

or

- ▶ **All vehicles (except Mercedes-AMG vehicles):** use the DYNAMIC SELECT button to change the drive program.
- ▶ **Mercedes-AMG vehicles:** use the DYNAMIC SELECT controller to change the drive program.

### Permanent setting

#### All vehicles (except Mercedes-AMG vehicles)

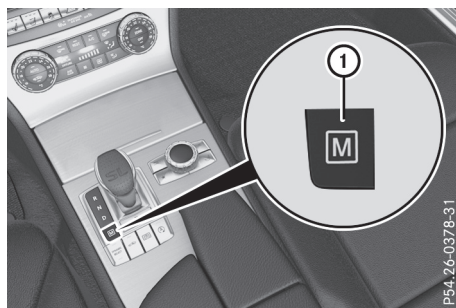

- ▶ **To activate:** shift the selector lever to **D**.
- ▶ Press button ①.
- ▶ **To deactivate:** press button ①.

### Mercedes-AMG vehicles



- ▶ **To activate:** shift the selector lever to **D**.
  - ▶ Press button ①.
  - ▶ **To deactivate:** press button ①.
- or
- ▶ If position D (automatic transmission) is selected for the transmission in drive program I: shift to drive program I with the DYNAMIC SELECT controller.

### Shifting gears

#### All vehicles (except Mercedes-AMG vehicles)

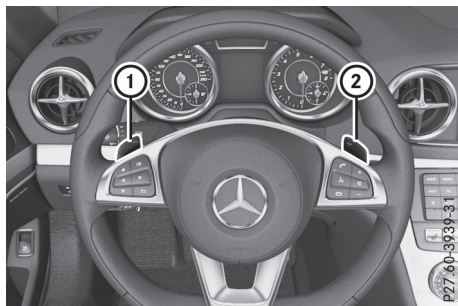

- ▶ **To shift up:** pull steering wheel paddle shifter ②.  
The automatic transmission shifts up to the next gear.  
If the maximum engine speed in the currently engaged gear is reached and you continue to accelerate, the automatic transmis-

sion automatically shifts up in order to prevent engine damage.

- ▶ **To shift down:** pull steering wheel paddle shifter ①.

The automatic transmission shifts down to the next gear.

Automatic down shifting occurs when coasting.

If the engine were to exceed the maximum engine speed when shifting down, the automatic transmission protects against engine damage by not shifting down.

### Mercedes-AMG vehicles

- ▶ **!** If manual gearshifting is permanently activated, the automatic transmission does not shift up automatically even when the engine limiting speed for the current gear is reached. When the engine limiting speed is reached, the fuel supply is cut to prevent the engine from overrevving. Always make sure that the engine speed does not reach the red area of the tachometer. There is otherwise a risk of engine damage.

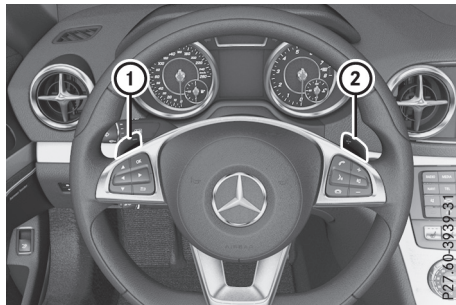

- ▶ **To shift up:** pull steering wheel paddle shifter ②.  
The automatic transmission shifts up to the next gear.
- ▶ **To shift down:** pull steering wheel paddle shifter ①.  
The automatic transmission shifts down to the next gear.  
Automatic down shifting occurs when coasting.  
If the engine were to exceed the maximum engine speed when shifting down, the automatic transmission protects against engine damage by not shifting down.

## Shift recommendation

### All vehicles (except Mercedes-AMG vehicles)



The gearshift recommendations assist you in adopting an economical driving style. The recommended gear is shown in the multifunction display.

- Shift to recommended gear ② according to gearshift recommendation ① when shown in the multifunction display of the instrument cluster.

### Mercedes-AMG vehicles



The gearshift recommendations assist you in adopting an economical driving style. The recommended gear is shown in the multifunction display.

- Shift to recommended gear ② according to gearshift recommendation ① when shown in the multifunction display of the instrument cluster.

### Upshifting (Mercedes-AMG vehicles)

- ! If manual gearshifting is permanently activated, the automatic transmission does not

shift up automatically even when the engine limiting speed for the current gear is reached. When the engine limiting speed is reached, the fuel supply is cut to prevent the engine from overrevving. Always make sure that the engine speed does not reach the red area of the tachometer. There is otherwise a risk of engine damage.



- ① Gear indicator
- ② Upshift indicator

Before the engine speed reaches the red area, an upshift indicator will be shown in the multifunction display.

- When the **UP** message appears in the multifunction display, pull on the right-hand steering wheel paddle shifter.

### Kickdown

- For maximum acceleration, depress the accelerator pedal beyond the pressure point. The automatic transmission shifts to a lower gear depending on the engine speed.
- Shift back up once the desired speed is reached.

During kickdown, you cannot shift gears using the steering wheel paddle shifters.

If you apply full throttle, the automatic transmission shifts up to the next gear when the maximum engine speed is reached. This prevents the engine from overrevving.

**Mercedes-AMG vehicles:** kickdown is only possible in the temporary setting.

### Problems with the transmission

Problem	Possible causes/consequences and ► Solutions
The transmission has problems shifting gear.	The transmission is losing oil. ► Have the transmission checked at a qualified specialist workshop immediately.
The acceleration ability is deteriorating. The transmission no longer changes gear.	The transmission is in emergency mode. <b>All vehicles (except Mercedes-AMG vehicles):</b> it is only partly possible to engage the gears, or the transmission is in position <b>[N]</b> . <b>Mercedes-AMG vehicles:</b> it is only possible to shift into <b>second</b> gear and reverse gear. ► Stop the vehicle. ► Shift the transmission to position <b>[P]</b> . ► Switch off the engine. ► Wait at least ten seconds before restarting the engine. ► Shift the transmission to position <b>[D]</b> or <b>[R]</b> . <b>Mercedes-AMG vehicles:</b> if <b>[D]</b> is selected, the transmission shifts to <b>second</b> gear if <b>[R]</b> is selected, the transmission shifts into reverse gear. ► Have the transmission checked at a qualified specialist workshop immediately.

### Refueling

#### Important safety notes

#### WARNING

Fuel is highly flammable. Risk of fire and explosion by improper handling of fuel.

You must avoid fire, open flames, smoking and creating sparks. Switch off the ignition before refueling and, if present, switch off the auxiliary heating.

#### WARNING

Fuels are toxic and harmful to health. There is a risk of injury.

You must avoid fuels coming into contact with skin, eyes and clothes or being swallowed.

Do not inhale the fuel vapors. Keep children away from fuels.

Keep doors and windows closed during the refueling process.

If you or others come into contact with fuel, observe the following points:

- Immediately rinse the fuel off your skin with soap and water.
- If you get fuel into your eyes, immediately rinse your eyes thoroughly with clean water. Seek medical attention immediately.
- Seek medical attention immediately if fuel has been swallowed. Do not induce vomiting.
- Immediately change out of clothing which has come into contact with fuel.

#### WARNING

Electrostatic charging can lead to the creation of sparks and ignite fuel vapor. There is a risk of fire and explosion.

Touch the metallic body of the vehicle before you open the fuel filler cap or handle the pump nozzle. Any possible electrostatic charge present will in this way be depleted.



Do not get into the vehicle again during the refueling process. Otherwise, electrostatic charge could build up again.

Do not get into the vehicle again during the refueling process. Otherwise, electrostatic charge could build up again.

**!** Do not use diesel to refuel vehicles with a gasoline engine. Do not switch on the ignition if you accidentally refuel with the wrong fuel. Otherwise, the fuel will enter the fuel system. Even small amounts of the wrong fuel could result in damage to the fuel system and the engine. Notify a qualified specialist workshop and have the fuel tank and fuel lines drained completely.

**!** Overfilling the fuel tank could damage the fuel system.

**!** Take care not to spill any fuel on painted surfaces. You could otherwise damage the paintwork.

**!** Use a filter when adding fuel from a fuel can. The fuel lines and/or the fuel injection system could otherwise be blocked by particles from the fuel can.

If you overfill the fuel tank, fuel could spray out when the fuel pump nozzle is removed.

For further information on fuel and fuel quality (▷ page 322).

## Refueling

### General information

The fuel filler flap is unlocked or locked automatically when you unlock or lock the vehicle with the SmartKey or using KEYLESS-GO.

The position of the fuel filler cap is displayed  in the instrument cluster. The arrow next to the filling pump indicates the side of the vehicle.

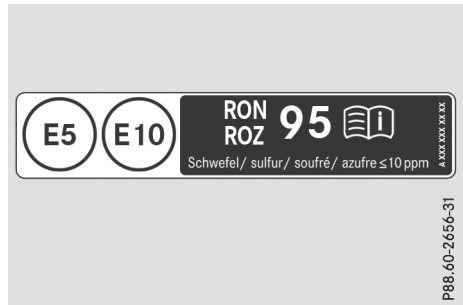

On the inside of the fuel filler cap, you will find information on the recommended fuel.

### Opening the fuel filler flap

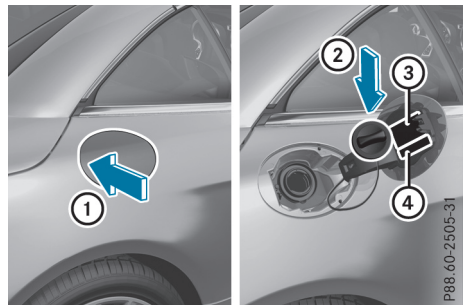



- ① To open the fuel filler flap
- ② To insert the fuel filler cap
- ③ Tire pressure table
- ④ Instruction label for fuel type to be refueled

- ▶ Switch the engine off.
- ▶ Remove the SmartKey from the ignition lock.
- ▶ Press the fuel filler flap in the direction of arrow ①. The fuel filler flap swings up.
- ▶ Turn the fuel filler cap counter-clockwise and remove it.
- ▶ Insert the fuel filler cap into the holder bracket on the inside of fuel filler flap ②.
- ▶ Completely insert the filler neck of the fuel pump nozzle into the tank, hook in place and refuel.
- ▶ Only fill the tank until the pump nozzle switches off.
- i** Do not add any more fuel after the pump stops filling for the first time. Otherwise, fuel may leak out.

## Closing the fuel filler flap



- ▶ Replace the cap on the filler neck and turn clockwise until it engages audibly.
- ▶ Close the fuel filler flap.

**i** Close the fuel filler flap before locking the vehicle.

**i** If you are driving with the fuel filler cap open, the  reserve fuel warning lamp flashes. The  Check Engine warning lamp may also light up. A message appears in the multifunction display (▷ page 221).

For further information on warning and indicator lamps in the instrument cluster, see (▷ page 239).

## Problems with fuel and the fuel tank

Problem	Possible causes/consequences and ▶ Solutions
Fuel is leaking from the vehicle.	<p>The fuel line or the fuel tank is faulty.</p> <p> <b>WARNING</b></p> <p>Risk of explosion or fire.</p> <ul style="list-style-type: none"> <li>▶ Turn the SmartKey immediately to position  in the ignition lock (▷ page 126) and remove it.</li> <li>▶ Do not restart the engine under any circumstances.</li> <li>▶ Consult a qualified specialist workshop.</li> </ul>
The fuel filler flap cannot be opened.	<p>The fuel filler flap is not unlocked.</p> <ul style="list-style-type: none"> <li>▶ Unlock the vehicle (▷ page 74).</li> </ul> <p>The SmartKey battery is discharged or nearly discharged.</p> <ul style="list-style-type: none"> <li>▶ Unlock the vehicle using the mechanical key (▷ page 76).</li> </ul> <p>The fuel filler flap is unlocked, but the opening mechanism is jammed.</p> <ul style="list-style-type: none"> <li>▶ Consult a qualified specialist workshop.</li> </ul>

## Parking

### Important safety notes

#### **WARNING**

Flammable material such as leaves, grass or twigs may ignite if they come into contact with hot parts of the exhaust system or exhaust gas flow. There is a risk of fire.

Park the vehicle so that no flammable materials come into contact with parts of the vehicle which are hot. Take particular care not to park on dry grassland or harvested grain fields.

#### **WARNING**

If you leave children unsupervised in the vehicle, they could set it in motion by, for example:

- release the parking brake.
- shift the automatic transmission out of the parking position **P**.
- start the engine.

In addition, they may operate vehicle equipment and become trapped. There is a risk of an accident and injury.

When leaving the vehicle, always take the SmartKey with you and lock the vehicle.

Never leave children unsupervised in the vehicle.

**!** Always secure the vehicle correctly against rolling away. Otherwise, the vehicle or its drivetrain could be damaged.

To ensure that the vehicle is secured against rolling away unintentionally:

- the electric parking brake must be applied.
- the transmission must be in position **P**.
- the SmartKey must be removed from the ignition lock.
- the front wheels must be turned towards the curb on steep uphill or downhill gradients.

### Switching off the engine

#### WARNING

The automatic transmission switches to neutral position **N** when you switch off the engine. The vehicle may roll away. There is a risk of an accident.

After switching off the engine, always switch to parking position **P**. Prevent the parked vehicle from rolling away by applying the parking brake.

- ▶ Apply the electric parking brake.
- ▶ Shift the transmission to position **P** (▷ page 136).
- ▶ **With the SmartKey** : turn the SmartKey to position **0** in the ignition lock and remove it.  
The immobilizer is activated.
- ▶ **With KEYLESS-GO**: press the KEYLESS-GO Start/Stop button (▷ page 126).  
The engine stops and all the indicator lamps in the instrument cluster go out.  
If the driver's door is closed, this is the same as SmartKey position **1**. If the driver's door is open, this is the same as SmartKey position **0** (▷ page 126).

The engine can be switched off while the vehicle is in motion by pressing and holding the Start/Stop button for about three seconds. This function operates independently of the ECO start/stop automatic engine switch-off function.

### Electric parking brake

#### General notes

#### WARNING

If children are left unsupervised in the vehicle, they could:

- open doors, thereby endangering other persons or road users
- get out and be struck by oncoming traffic
- operate the vehicle's equipment

Additionally, children could set the vehicle in motion if, for example, they:

- release the parking brake
- shift the automatic transmission out of park position **P** or shift the manual transmission to neutral
- start the engine

There is a risk of an accident and injury.

When leaving the vehicle, always take the SmartKey with you and lock the vehicle. This also applies for the digital vehicle key if the "Digital Vehicle Key" function is activated via Mercedes me connect.

Always keep the SmartKey out of reach of children. This also applies for the Digital Vehicle Key if the "Digital Vehicle Key" function is activated via Mercedes me connect.

The function of the electric parking brake is dependent on the on-board voltage. If the on-board voltage is low or there is a malfunction in the system, it may not be possible to apply the released parking brake.

- ▶ If this is the case, only park the vehicle on level ground and secure it to prevent it rolling away.
- ▶ Shift the automatic transmission to position **P**.

It may not be possible to release an applied parking brake if the on-board voltage is low or there is a malfunction in the system. Contact a qualified specialist workshop.

The electric parking brake performs a function test at regular intervals while the engine is switched off. The sounds that can be heard while this is occurring are normal.

## Applying or releasing manually



### ► To apply: push handle ①.

When the electric parking brake is applied, the red **PARK** (USA only) or **(P)** (Canada only) indicator lamp lights up in the instrument cluster.

The electric parking brake can also be applied when the SmartKey is removed.

### ► To release: pull handle ①.

The red **PARK** (USA only) or **(P)** (Canada only) indicator lamp in the instrument cluster goes out.

The electric parking brake can only be released:

- when the SmartKey is in position **1** in the ignition lock (> page 126) or
- if the ignition was switched on using the Start/Stop button

## Applying automatically

The electric parking brake is automatically applied when the transmission is in position **P** and:

- the engine is switched off or
- the driver is not wearing a seat belt and the driver's door is opened

To prevent the electric parking brake from being automatically applied, pull handle ①.

The electric parking brake is also applied automatically if:

- Active Distance Assist DISTRONIC brings the vehicle to a standstill or
- the HOLD function is keeping the vehicle stationary

In addition, at least one of the following conditions must be fulfilled:

- the engine is switched off
- the driver is not wearing a seat belt and the driver's door is opened
- there is a system malfunction
- the power supply is insufficient
- the vehicle is stationary for a lengthy period

The red **PARK** (USA only) or **(P)** (Canada only) indicator lamp in the instrument cluster lights up.

The electric parking brake is not automatically applied if the engine is switched off by the ECO start/stop function.

## Releasing automatically

The electric parking brake is released automatically when all of the following conditions are fulfilled:

- the engine is running
- The seat belt tongue is engaged in the belt buckle
- the transmission is in position **D** or **R** and you depress the accelerator pedal or shift from position **P** to **D** or **R**
- if the transmission is in position **R**, the trunk lid must be closed

If the seat belt tongue is not engaged in the seat belt buckle, the following conditions must be fulfilled:

- the driver's door is closed
- you move the transmission out of position **P** or you have previously driven at a speed above 2 mph (3 km/h)
- if the transmission is in position **R**, the trunk lid must be closed

When the electric parking brake is released, the **(P)** indicator lamp goes out in the instrument cluster.

## Emergency braking

The vehicle can also be braked during an emergency by using the electric parking brake.

### ► While driving, push handle ① of the electric parking brake.

The vehicle is braked for as long as the handle of the electric parking brake is pressed. The longer the electric parking brake handle is depressed, the greater the braking force.

During braking:

- a warning tone sounds
- the **Release Parking Brake** message appears
- the red **PARK** (USA only) or **(P)** (Canada only) indicator lamp in the instrument cluster flashes

When the vehicle has been braked to a standstill, the electric parking brake is applied.

### Parking the vehicle for a long period

If you leave the vehicle parked for longer than four weeks, the battery may be damaged by exhaustive discharging.

If you leave the vehicle parked for longer than six weeks, the vehicle may suffer damage as a result of lack of use.

- ▶ Visit a qualified specialist workshop and seek advice.
- ❗ You can obtain information about trickle chargers from a qualified specialist workshop.

## Driving tips

### General notes

### Important safety notes

#### WARNING

If you switch off the ignition while driving, safety-relevant functions are only available with limitations, or not at all. This could affect, for example, the power steering and the brake boosting effect. You will require considerably more effort to steer and brake. There is a risk of an accident.

Do not switch off the ignition while driving.

#### WARNING

If you operate mobile communication equipment when driving, you may be distracted from the traffic situation. You could also lose control of the vehicle. There is a risk of an accident.

Only operate this equipment when the vehicle is stationary.

Observe the legal requirements for the country in which you are driving. Some jurisdictions prohibit the driver from using a mobile phone while driving a vehicle.

If you make a call while driving, always use hands-free mode. Only operate the telephone when the traffic situation permits. If you are unsure, pull over to a safe location and stop before operating the telephone.

Bear in mind that at a speed of only 30 mph (approximately 50 km/h), the vehicle covers a distance of 44 ft (approximately 14 m) per second.

### Drive sensibly – save fuel

Observe the following tips to save fuel:

- The tires should always be inflated to the recommended tire pressure.
- Remove unnecessary loads.
- Warm up the engine at low engine speeds.
- Avoid frequent acceleration or braking.
- Observe the service intervals in the Maintenance Booklet or in the service interval display. Have all the maintenance work carried in accordance with Daimler AG regulations.

Fuel consumption also increases when driving in cold weather, in stop-start traffic and in hilly terrain.

### Drinking and driving

#### WARNING

Drinking and driving and/or taking drugs and driving are very dangerous combinations. Even a small amount of alcohol or drugs can affect your reflexes, perceptions and judgment.

The possibility of a serious or even fatal accident is greatly increased when you drink or take drugs and drive.

Do not drink or take drugs and drive or allow anyone to drive who has been drinking or taking drugs.

## Emission control

### DANGER

Combustion engines emit poisonous exhaust gases such as carbon monoxide. Inhaling these exhaust gases is hazardous to health and can result in poisoning. There is a risk of fatal injury. Therefore, never leave the engine running in an enclosed space without adequate ventilation.

Certain engine systems are designed to keep the level of poisonous components in exhaust fumes within legal limits.

These systems only work at peak efficiency if they are serviced exactly in accordance with the manufacturer's specifications. Always have work on the engine carried out at a qualified specialist workshop. Mercedes-Benz recommends that you use an authorized Mercedes-Benz Center for this purpose. In particular, work relevant to safety or on safety-related systems must be carried out at a qualified specialist workshop.

The engine settings must not be changed under any circumstances. Furthermore, all specific service work must be carried out at regular intervals and in accordance with the Mercedes-Benz service requirements. Details can be found in the Maintenance Booklet.

## ECO display

The ECO display shows you how economical your driving style is. The ECO display assists you in achieving the most economical driving style for the selected settings and prevailing conditions. Your driving style can significantly influence the vehicle's consumption.



- ① Acceleration
- ② Coasting
- ③ Constant
- ④ Additional range achieved

Range ④ is shown under **Bonus fr. Start** and represents the additional range achieved since the beginning of the journey as a result of an adapted driving style.

If the fuel level has dropped into the reserve range, the **Fuel Low** message is shown in the multifunction display instead of range ④. The  warning lamp in the instrument cluster also lights up (▷ page 239).

The ECO display consists of three sections, with an inner and outer area. The sections correspond to the following three categories:

- |   |  |
|---|--|
| ① | <p><b>Acceleration</b> (evaluation of all acceleration processes):</p> <ul style="list-style-type: none"> <li>• the outer area fills up and the inner area lights up green: moderate acceleration, especially at higher speeds</li> <li>• the outer area empties and the inner area is gray: sporty acceleration</li> </ul>  |
| ② | <p><b>Coasting</b> (evaluation of all deceleration processes):</p> <ul style="list-style-type: none"> <li>• the outer area fills up and the inner area lights up green: anticipatory driving, keeping your distance and early release of the accelerator. The vehicle can coast without use of the brakes.</li> <li>• the outer area empties and the inner area is gray: frequent heavy braking</li> </ul> |
| ③ | <p><b>Constant</b> (continuous evaluation over the entire journey):</p> <ul style="list-style-type: none"> <li>• the outer area fills up and the inner area lights up green: constant speed and avoidance of unnecessary acceleration and deceleration</li> <li>• the outer area empties and the inner area is gray: fluctuations in speed</li> </ul>  |

The three inner areas display the current driving style and light up green as a result of a particularly economical driving style. Depending on the driving situation, up to two areas may light up simultaneously.

At the beginning of the journey, the three outer areas are empty and fill up as a result of



economical driving. A higher level indicates a more economical driving style. If the three outer areas are completely filled at the same time, the driver has adopted the most economical driving style for the selected settings and prevailing conditions. The ECO display border lights up.

The ECO display does not indicate the actual fuel consumption. The additionally achieved range displayed under **Bonus fr. start** does not indicate a fixed consumption reduction.

In addition to driving style, the actual consumption is affected by other factors, such as:

- load
- tire pressure
- cold start
- choice of route
- active electrical consumers

These factors are not included in the ECO display.

An economical driving style specially requires driving at moderate engine speeds.

Achieving a higher value in the categories "Acceleration" and "Constant":

- observe the gearshift recommendations.
- drive the vehicle in drive program **C** or **E**.

In urban traffic and stop-start traffic, drive program **C** is recommended.

On long journeys at a constant speed, e.g. on the highway, only the outer area for "constant" will change.

The ECO display summarizes the driving style from the start of the journey to its completion. Therefore, there are more marked changes in the outer areas at the start of a journey. On longer journeys, there are fewer changes. For more marked changes, perform a manual rest (▷ page 194).

Further information on the ECO display (▷ page 193).

## Braking

### Important safety notes

#### WARNING

If you shift down on a slippery road surface in an attempt to increase the engine's braking effect, the drive wheels could lose their

grip. There is an increased danger of skidding and accidents.

Do not shift down for additional engine braking on a slippery road surface.

### Downhill gradients

 On long, steep gradients, you must reduce the load on the brakes. To use engine braking, shift to a lower gear in good time. This helps you to avoid overheating the brakes and wearing them out excessively.

When making use of the engine braking effect, it is possible that a drive wheel may not turn for some time, e.g. in the case of suddenly changing or slippery road surface conditions. This could cause damage to the drive train. This type of damage is not covered by the Mercedes-Benz warranty.

Change into a lower gear in good time on long and steep downhill gradients. This is especially important if the vehicle is laden.

This also applies if you have activated cruise control or Active Distance Assist DISTRONIC.

### Heavy and light loads

#### WARNING

If you rest your foot on the brake pedal while driving, the braking system can overheat. This increases the stopping distance and can even cause the braking system to fail. There is a risk of an accident.

Never use the brake pedal as a footrest. Never depress the brake pedal and the accelerator pedal at the same time.

 Depressing the brake pedal constantly results in excessive and premature wear to the brake pads.

If the brakes have been subjected to a heavy load, do not stop the vehicle immediately, but drive on for a short while. This allows the airflow to cool the brakes more quickly.

### Wet roads

If you have driven for a long time in heavy rain without braking, there may be a delayed reaction from the brakes when braking for the first

time. This may also occur after the vehicle has been washed or driven through deep water.

You then have to depress the brake pedal more firmly. Maintain a greater distance from the vehicle in front.

After driving on a wet road or having the vehicle washed, brake firmly while paying attention to the traffic conditions. This will warm up the brake discs, thereby drying them more quickly and protecting them against corrosion.

### Limited braking performance on salt-treated roads

If you drive on salted roads, a layer of salt residue may form on the brake discs and brake pads. This can result in a significantly longer braking distance.

- In order to prevent any salt build-up, apply the brakes occasionally while paying attention to the traffic conditions.
- Carefully depress the brake pedal at the beginning and end of a journey.
- Maintain a greater distance to the vehicle ahead.

### Servicing the brakes

❗ The brake fluid level may be too low, if:

- if the red brake warning lamp lights up in the instrument cluster and
- you hear a warning tone while the engine is running

Observe additional warning messages in the multifunction display.

The brake fluid level may be too low due to brake pad wear or leaking brake lines.

Have the brake system checked immediately. Consult a qualified specialist workshop to arrange this.

❗ As the ESP® system operates automatically, the engine and the ignition must be switched off (the SmartKey must be in position **0** or **1** in the ignition lock or the Start/Stop button must be in position **0** or **1**), if:

- the parking brake is tested using a brake dynamometer.
- the vehicle is towed with the front axle raised.

Braking triggered automatically by ESP® may cause severe damage to the brake system.

All checks and maintenance work on the brake system must be carried out at a qualified specialist workshop.

Have brake pads installed and brake fluid replaced at a qualified specialist workshop.

If the brake system has only been subject to moderate loads, you should test the functionality of your brakes at regular intervals.

Information on BAS (Brake Assist) (▷ page 61) and on Brake Assist with Cross-Traffic Assist (▷ page 61).

Mercedes-Benz recommends that you only have brake pads/linings installed on your vehicle which have been approved for Mercedes-Benz vehicles or which correspond to an equivalent quality standard. Brake pads/linings which have not been approved for Mercedes-Benz vehicles or which are not of an equivalent quality could affect your vehicle's operating safety.

Mercedes-Benz recommends that you only use brake fluid that has been specially approved for your vehicle by Mercedes-Benz, or which corresponds to an equivalent quality standard. Brake fluid which has not been approved for Mercedes-Benz vehicles or which is not of an equivalent quality could affect your vehicle's operating safety.

### High-performance and ceramic brake system (Mercedes-AMG vehicles)

The AMG brake systems are designed for heavy loads. This may lead to noise when braking. This will depend on:

- Speed
- Braking force
- Ambient conditions, e.g. temperature and humidity

The wear of individual components of the brake system, such as the brake pads/linings or brake discs, depends on the individual driving style and operating conditions.

For this reason, it is impossible to state a mileage that will be valid under all circumstances. An aggressive driving style will lead to high wear. You can obtain more information on this from a qualified specialist workshop.

New and replaced brake pads and discs only reach their optimum braking effect after several hundred kilometers of driving. Compensate for this by applying greater force to the brake pedal. Keep this in mind, and adapt your driving and braking accordingly during this break-in period.

Excessive heavy braking results in correspondingly high brake wear. Observe the brake system warning lamp in the instrument cluster and note any brake status messages in the multifunction display. Especially for high performance driving, it is important to maintain and have the brake system checked regularly.

## Driving on wet roads

### Hydroplaning

If water has accumulated to a certain depth on the road surface, there is a danger of hydroplaning occurring.

For this reason, in the event of heavy rain or in conditions in which hydroplaning may occur, you must drive in the following manner:

- lower your speed
- avoid ruts
- avoid sudden steering movements
- brake carefully

### Driving on flooded roads

**!** Do not drive through flooded areas. Check the depth of any water before driving through it. Drive slowly through standing water. Otherwise, water could enter the vehicle interior or engine compartment. It can then damage the engine's or automatic transmission's electronic components. It can also be sucked in by the engine's air intake connection and cause engine damage.

## Winter driving

### WARNING

If you shift down on a slippery road surface in an attempt to increase the engine's braking effect, the drive wheels could lose their

grip. There is an increased danger of skidding and accidents.

Do not shift down for additional engine braking on a slippery road surface.

### DANGER

If the exhaust pipe is blocked or adequate ventilation is not possible, poisonous gases such as carbon monoxide (CO) may enter the vehicle. This is the case, e.g. if the vehicle becomes trapped in snow. There is a risk of fatal injury.

If you leave the engine or the auxiliary heating running, make sure the exhaust pipe and area around the vehicle are clear of snow. To ensure an adequate supply of fresh air, open a window on the side of the vehicle that is not facing into the wind.

Have your vehicle winter-proofed at a qualified specialist workshop at the onset of winter.

Drive particularly carefully on slippery road surfaces. Avoid sudden acceleration, steering and braking maneuvers. Do not use cruise control.

If the vehicle threatens to skid or cannot be stopped when moving at low speed:

► Shift the transmission to position **N**.

The outside temperature indicator is not designed to serve as an ice-warning device and is therefore unsuitable for that purpose. Changes in the outside temperature are displayed after a short delay.

Indicated temperatures just above the freezing point do not guarantee that the road surface is free of ice. The road may still be icy, especially in wooded areas or on bridges. The vehicle could skid if you fail to adapt your driving style. Always adapt your driving style and drive at a speed to suit the prevailing weather conditions.

You should pay special attention to road conditions when temperatures are around freezing point.

For more information on driving with snow chains, see (> page 295).

For more information on driving with summer tires, see (> page 295).

Observe the notes in the "Winter operation" section (▷ page 295).

## Driving systems

### Cruise control

#### General notes

Cruise control maintains a constant road speed for you. It brakes automatically in order to avoid exceeding the set speed. On long and steep downhill gradients, especially if the vehicle is laden, you must select a lower gear in good time. By doing so, you will make use of the braking effect of the engine. This relieves the load on the brake system and prevents the brakes from overheating and wearing too quickly.

Use cruise control only if road and traffic conditions make it appropriate to maintain a steady speed for a prolonged period. You can store any road speed above 20 mph (30 km/h).

#### Important safety notes

If you fail to adapt your driving style, cruise control can neither reduce the risk of an accident nor override the laws of physics. Cruise control cannot take into account the road, traffic and weather conditions. Cruise control is only an aid. You are responsible for the distance to the vehicle in front, for vehicle speed, for braking in good time and for staying in lane.

Do not use cruise control:

- in road and traffic conditions which do not allow you to maintain a constant speed e.g. in heavy traffic or on winding roads
- on slippery road surfaces. Braking or accelerating could cause the drive wheels to lose traction and the vehicle could then skid
- when there is poor visibility, e.g. due to fog, heavy rain or snow

If there is a change of drivers, advise the new driver of the speed stored.

#### Cruise control lever

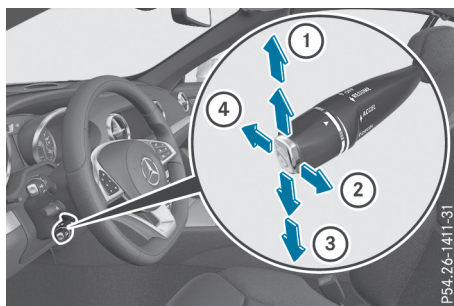

- ① To store the current speed or a higher speed
- ② To store the current speed or calls up the last stored speed
- ③ To store the current speed or a lower speed
- ④ To deactivate cruise control

When you activate cruise control, the stored speed is shown in the multifunction display for five seconds. The speed is then permanently displayed in the status indicator together with the  symbol.

In vehicles with a segment circle in the speedometer, the segments between the currently stored speed and the end of the segment circle light up.

#### Storing, maintaining and calling up a speed

##### Storing and maintaining a speed

- ▶ Accelerate the vehicle to the desired speed.
- ▶ Briefly press the cruise control lever up **①** or down **④**.
- ▶ Remove your foot from the accelerator pedal.  
Cruise control is activated. The vehicle automatically maintains the stored speed.

You can store the current speed if you are driving faster than 20 mph (30 km/h).

- i** Cruise control may be unable to maintain the stored speed on uphill gradients. The stored speed is resumed when the gradient evens out. Cruise control maintains the stored speed on downhill gradients by automatically applying the brakes.

## Storing or calling up a speed

### WARNING

If you call up the stored speed and it differs from the current speed, the vehicle accelerates or decelerates. If you do not know the stored speed, the vehicle could accelerate or brake unexpectedly. There is a risk of an accident.

Pay attention to the road and traffic conditions before calling up the stored speed. If you do not know the stored speed, store the desired speed again.



- ▶ Briefly pull the cruise control lever towards you .
- ▶ Remove your foot from the accelerator pedal.  
The first time cruise control is activated, it stores the current speed or regulates the speed of the vehicle to the previously stored speed.

## Setting a speed



### WARNING

Keep in mind that it may take a brief moment until the vehicle has made the necessary adjustments.

Increase or decrease the set vehicle speed to a value that the prevailing road conditions and legal speed limits permit. Otherwise, sudden and unexpected acceleration or deceleration of the vehicle could cause an accident and/or serious injury to you and others.

- ▶ **To adjust the set speed in 1 mph increments (1 km/h increments):** briefly press the cruise control lever up  to the pressure point for a higher speed, or down  for a lower speed.  
Every time the cruise control lever is pressed up or down, the last speed stored is increased or reduced.
- ▶ **To adjust the set speed in 5 mph increments (10 km/h increments):** briefly press the cruise control lever up  past the

pressure point for a higher speed, or down  for a lower speed.  
Every time the cruise control lever is pressed up or down, the last speed stored is increased or reduced.

-  The speed indicated in the speedometer may differ slightly from the speed stored.
-  Cruise control is not deactivated if you depress the accelerator pedal. For example, if you accelerate briefly to overtake, cruise control adjusts the vehicle's speed to the last speed stored after you have finished overtaking.

## Deactivating cruise control

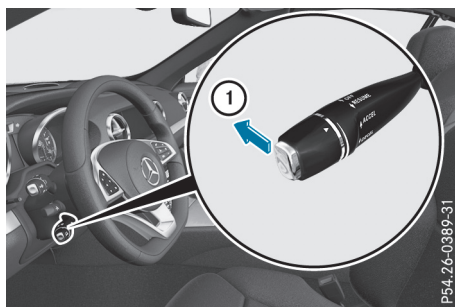

There are several ways to deactivate cruise control:

- ▶ Briefly press the cruise control lever forwards .
- or
- ▶ Brake.

Cruise control is automatically deactivated if:

- you engage the electric parking brake
- you are driving at less than 20 mph (30 km/h)
- ESP<sup>®</sup> intervenes or you deactivate ESP<sup>®</sup>
- Brake Assist intervenes
- you move out of transmission position 

If cruise control is deactivated, you will hear a warning tone. You will see the **Cruise Control Off** message in the multifunction display for approximately five seconds.

-  When you switch off the engine, the last speed stored is cleared.

## Active Distance Assist DISTRONIC

### General notes

Active Distance Assist DISTRONIC regulates the speed and automatically helps you maintain the distance from the vehicle detected in front. Vehicles are detected with the aid of the radar sensor system. Active Distance Assist DISTRONIC brakes automatically to avoid exceeding the set speed or to maintain the designated distance from the vehicle in front.

You must select a lower gear in good time on long and steep downhill gradients, especially if the vehicle is laden. By doing so, you will make use of the braking effect of the engine. This relieves the load on the brake system and prevents the brakes from overheating and wearing too quickly.

If Active Distance Assist DISTRONIC detects that there is a risk of a collision with the vehicle in front, you will be warned visually and audibly. Active Distance Assist DISTRONIC cannot prevent a collision without your intervention. An intermittent warning tone will then sound and the distance warning lamp will light up in the instrument cluster. Brake immediately in order to increase the distance from the vehicle in front, or take evasive action, provided it is safe to do so.

For Active Distance Assist DISTRONIC to assist you when driving, the radar sensor system must be operational.

Active Distance Assist DISTRONIC operates in the speed range between 0 mph (0 km/h) and 120 mph (200 km/h).

Do not use Active Distance Assist DISTRONIC while driving on roads with steep gradients.

As Active Distance Assist DISTRONIC transmits radar waves, it can resemble the radar detectors of the responsible authorities. You can refer to the relevant chapter in the Operator's Manual if questions are asked about this.

#### USA only:

This device has been approved by the FCC as a "Vehicular Radar System". The radar sensor is intended for use in an automotive radar system only. Removing, tampering with, or altering the device will void any warranties, and is not permitted by the FCC. Do not tamper with, alter, or use in any non-approved way.

Any unauthorized modification to this device could void the user's authority to operate the equipment.

 Canada only: This device complies with RSS-210 of Industry Canada. Operation is subject to the following two conditions:

1. This device may not cause interference, and
2. This device must accept any interference received, including interference that may cause undesired operation of the device.

Removal, tampering, or altering of the device will void any warranties, and is not permitted. Do not tamper with, alter, or use in any non-approved way.

Any unauthorized modification to this device could void the user's authority to operate the equipment.

### Important safety notes

#### WARNING

Active Distance Assist DISTRONIC does not react to:

- people or animals
- stationary objects in the road, e.g. stopped or parked vehicles
- oncoming vehicles and crossing traffic

As a result, Active Distance Assist DISTRONIC may neither give warnings nor intervene in such situations. There is a risk of an accident.

Always pay careful attention to the traffic situation and be ready to brake.

#### WARNING

Active Distance Assist DISTRONIC does not react to:

- people or animals
- stationary objects in the road, e.g. stopped or parked vehicles (vehicles without the Driving Assistance package)
- stationary objects in the road, e.g. stopped or parked vehicles, if sufficient detection is not possible (vehicles with the Driving Assistance package)
- oncoming vehicles and crossing traffic



As a result, Active Distance Assist DISTRONIC may neither give warnings nor intervene in such situations. There is a risk of an accident.

Always pay careful attention to the traffic situation and be ready to brake.

### WARNING

Distance keeping assistant cannot always clearly identify other road users and complex traffic situations.

In such cases, distance keeping assistant can:

- accelerate or brake the vehicle unexpectedly
- intervene unexpectedly

There is a risk of an accident.

Continue to drive carefully and be ready to brake, especially if distance keeping assistant warns you.

### WARNING

Active Distance Assist DISTRONIC brakes your vehicle with up to 50% of the maximum possible deceleration. If this deceleration is not sufficient, Active Distance Assist DISTRONIC alerts you with a visual and acoustic warning. There is a risk of an accident.

Adjust your speed in these cases and maintain sufficient distance.

Apply the brakes yourself and/or take evasive action.

- !** When Active Distance Assist DISTRONIC or the HOLD function is activated, the vehicle brakes automatically in certain situations.

To avoid damage to the vehicle, deactivate Active Distance Assist DISTRONIC and the HOLD function in the following or similar situations:

- when towing the vehicle
- in the car wash

Active Distance Assist DISTRONIC can neither reduce the risk of an accident if you fail to

adapt your driving style, nor override the laws of physics. Active Distance Assist DISTRONIC cannot take into account road, weather or traffic conditions. Active Distance Assist DISTRONIC is only an aid. You are responsible for the distance to the vehicle in front, for vehicle speed, for braking in good time and for staying in your lane.

Do not use Active Distance Assist DISTRONIC:

- In road and traffic conditions which do not allow you to maintain a constant speed, e.g. in heavy traffic or on winding roads
- on slippery road surfaces. Braking or accelerating could cause the drive wheels to lose traction and the vehicle could then skid
- In poor visibility, e.g. due to fog, heavy rain or snow

Active Distance Assist DISTRONIC may not detect narrow vehicles driving in front, e.g. motorcycles, or vehicles driving in a staggered formation.

In particular, the detection of obstacles can be impaired if:

- There is dirt on the sensors or anything else covering the sensors
- There is snow or heavy rain
- There is interference by other radar sources
- There are strong radar reflections, for example in parking garages

If Active Distance Assist DISTRONIC no longer detects a vehicle in front, Distance Pilot DISTRONIC may unexpectedly accelerate to the speed stored.

This speed may:

- Be too high if you are driving in a turning lane or an exit lane
- Be so high when driving in the right-hand lane that you overtake vehicles in the left-hand lane
- Be so high in the left lane that you pass vehicles driving on the right

If there is a change of drivers, advise the new driver of the speed stored.

## Cruise control lever

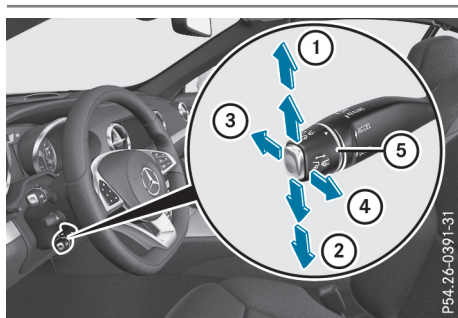

### Cruise control lever

- ① To store the current speed or a higher speed
- ② To set a specified minimum distance
- ③ To store the current speed or call up the last stored speed
- ④ To store the current speed or a lower speed
- ⑤ To deactivate Active Distance Assist DISTRONIC

## Activating Active Distance Assist DISTRONIC and storing, maintaining and calling up a speed

### Important safety notes

**!** When Active Distance Assist DISTRONIC or the HOLD function is activated, the vehicle brakes automatically in certain situations.

To avoid damage to the vehicle, deactivate Active Distance Assist DISTRONIC and the HOLD function in the following or similar situations:

- when towing the vehicle
- in the car wash

To activate Active Distance Assist DISTRONIC, the following conditions must be fulfilled:

- the engine must be started. It may take up to two minutes of driving before Active Distance Assist DISTRONIC is ready for use.
- the electric parking brake must be released.
- ESP® must be active, but not intervening.
- Active Parking Assist must not be activated.
- the transmission must be in position **[D]**.

- the driver's door must be closed when you shift from **[P]** to **[D]** or your seat belt must be fastened.
- the front-passenger door must be closed.
- the vehicle must not skid.

### Activating

- ▶ Briefly pull the cruise control lever towards you ④, up ① or down ② . Active Distance Assist DISTRONIC is activated.
- ▶ **To adjust the set speed in 1 mph increments (1 km/h increments):** briefly press the cruise control lever up ① to the pressure point for a higher speed, or down ② to the pressure point for a lower speed. Every time the cruise control lever is pressed up or down, the last speed stored is increased or reduced.

or

- ▶ **To adjust the set speed in 5 mph increments (10 km/h increments):** briefly press the cruise control lever up ① past the pressure point for a higher speed, or down ② past the pressure point for a lower speed. Every time the cruise control lever is pressed up or down, the last speed stored is increased or reduced.
- ▶ Remove your foot from the accelerator pedal. Your vehicle adapts its speed to that of the vehicle in front, but only up to the desired stored speed.

**i** If you do not fully release the accelerator pedal, the **Active Distance Assist passive** message appears in the multifunction display. The set distance to a slower-moving vehicle in front will then not be maintained. You will be driving at the speed you determine by the position of the accelerator pedal.

You can also activate Active Distance Assist DISTRONIC when stationary. The lowest speed that can be set is 20 mph (30 km/h).

### Activating at the current speed/last stored speed

#### **⚠ WARNING**

If you call up the stored speed and it differs from the current speed, the vehicle accelerates.

ates or decelerates. If you do not know the stored speed, the vehicle could accelerate or brake unexpectedly. There is a risk of an accident.

Pay attention to the road and traffic conditions before calling up the stored speed. If you do not know the stored speed, store the desired speed again.

- ▶ Briefly pull the cruise control lever towards you (4).
- ▶ Remove your foot from the accelerator pedal.  
The first time Active Distance Assist DISTRONIC is activated, it stores the current speed or regulates the speed of the vehicle to the previously stored speed.

### Pulling away and driving

- ▶ **If you want to pull away with Active Distance Assist DISTRONIC:** remove your foot from the brake pedal.

- ▶ Briefly pull the cruise control lever towards you (4).

or

- ▶ If Active Distance Assist DISTRONIC is activated: accelerate briefly.  
Your vehicle pulls away and adapts its speed to that of the vehicle in front. If no vehicle is detected in front, your vehicle accelerates to the set speed.

The vehicle can also pull away when it is facing an unidentified obstacle or is driving on a different line from another vehicle. The vehicle then brakes automatically. Be ready to brake at all times.

If there is no vehicle in front, Active Distance Assist DISTRONIC operates in the same way as cruise control.

If Active Distance Assist DISTRONIC detects a slower-moving vehicle in front, it brakes your vehicle. In this way, the distance you have selected is maintained.

If Active Distance Assist DISTRONIC detects a faster-moving vehicle in front, it increases the driving speed. However, the vehicle is only accelerated up to the speed you have stored.

### Selecting the drive program

**All vehicles (except AMG vehicles):** Active Distance Assist DISTRONIC supports a sporty driving style when you have selected the **S** or **S+** drive program (▷ page 132). Acceleration behind the vehicle in front or to the set speed is then noticeably more dynamic. If you have selected the **C** or **E** driving program, the vehicle accelerates more gently. This setting is recommended in stop-and-start traffic.

**AMG vehicles:** Active Distance Assist DISTRONIC supports a sporty driving style when you have selected the **S** or **S+** or **M** drive program (▷ page 133). Acceleration behind the vehicle in front or to the set speed is then noticeably more dynamic. When you select the **C** drive program, the vehicle accelerates more gently. This setting is recommended in stop-and-start traffic.

### Changing lanes

If you want to change to the overtaking lane on multi-lane roads, Active Distance Assist DISTRONIC supports you if:

- you are driving faster than 45 mph (70 km/h)
- Active Distance Assist DISTRONIC is maintaining the distance to a vehicle in front
- you switch on the appropriate turn signal
- Active Distance Assist DISTRONIC does not currently detect a danger of collision

If these conditions are fulfilled, your vehicle is accelerated. Acceleration will be interrupted if changing lanes takes too long or if the distance between your vehicle and the vehicle in front becomes too small.

- i** When you change lanes, Active Distance Assist DISTRONIC monitors the left lane on left-hand-drive vehicles or the right lane on right-hand-drive vehicles.

### Stopping

If Active Distance Assist DISTRONIC detects that the vehicle in front is stopping, it brakes your vehicle until it is stationary.

Once your vehicle is stationary, it remains stationary and you do not need to depress the brake. After a time, the electric parking brake secures the vehicle and relieves the service brake.

Depending on the specified minimum distance, your vehicle will come to a standstill at a suffi-

cient distance behind the vehicle in front. The specified minimum distance is set using the control on the cruise control lever.

The electric parking brake secures the vehicle automatically if Active Distance Assist DISTRONIC is activated and:

- the driver's door is open and the driver's seat belt is unfastened
- the engine is switched off, unless it is automatically switched off by the ECO start/stop function
- a system malfunction occurs
- the power supply is not sufficient

If a malfunction in the electric parking brake occurs, then the transmission may also be shifted into position **P** automatically.

### Setting a speed

Keep in mind that it may take a brief moment until the vehicle has accelerated or braked to the speed set.

- ▶ **To adjust the set speed in 1 mph increments (1 km/h increments):** briefly press the cruise control lever up **①** to the pressure point for a higher speed, or down **②** for a lower speed.

Every time the cruise control lever is pressed up or down, the last speed stored is increased or reduced.

- ▶ **To adjust the set speed in 5 mph increments (10 km/h increments):** briefly press the cruise control lever up **①** past the pressure point for a higher speed, or down **②** for a lower speed.

Every time the cruise control lever is pressed up or down, the last speed stored is increased or reduced.

### Setting a specified minimum distance

You can set the specified minimum distance for Active Distance Assist DISTRONIC by varying the time span between one and two seconds. This determines the distance that Active Distance Assist DISTRONIC is to maintain from the vehicle in front, depending on the road speed. You can see this distance in the multi-function display (▷ page 160).

The specified minimum distance can be changed while Active Distance Assist DISTRONIC is switched on or off.

Make sure that you maintain a sufficiently safe distance from the vehicle in front. Adjust the distance to the vehicle in front if necessary.

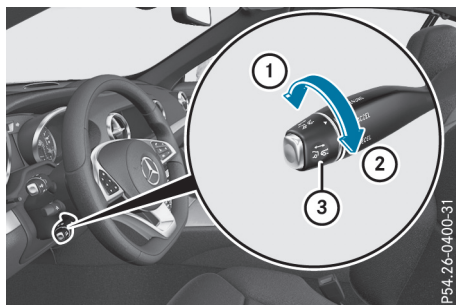

Cruise control lever

- ▶ **To increase:** turn control **③** toward **②**. Active Distance Assist DISTRONIC then maintains a greater distance between your vehicle and the vehicle in front.
- ▶ **To decrease:** turn control **③** toward **①**. Active Distance Assist DISTRONIC then maintains a shorter distance between your vehicle and the vehicle in front.

### Active Distance Assist DISTRONIC displays in the instrument cluster

#### Displays in the speedometer



When Active Distance Assist DISTRONIC is activated, one or more segments **②** in the set speed range light up.

If Active Distance Assist DISTRONIC detects a vehicle in front, segments **②** from speed of the vehicle in front **③** to stored speed **①** light up.

- i** For design reasons, the speed displayed on the speedometer may differ slightly from

the speed set for Active Distance Assist DISTRONIC.

### Display when Active Distance Assist DISTRONIC is deactivated

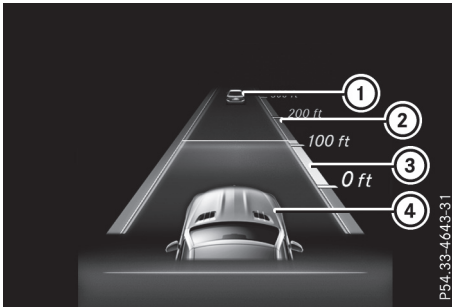

- ① Vehicle in front, if detected
- ② Distance indicator, current distance to the vehicle in front
- ③ Specified minimum distance to the vehicle in front; adjustable
- ④ Your vehicle

► Select the **Assistance Graphic** function using the on-board computer (► page 198).

### Display when Active Distance Assist DISTRONIC is activated

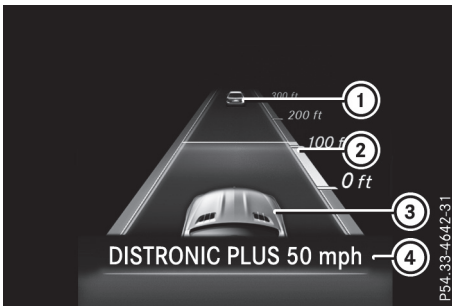

- ① Vehicle in front, if detected
- ② Specified minimum distance to the vehicle in front; adjustable
- ③ Your vehicle
- ④ Active Distance Assist DISTRONIC

► Select the **Assistance Graphic** function using the on-board computer (► page 198).

You will initially see the stored speed for approximately five seconds when you activate Active Distance Assist DISTRONIC.

### Deactivating Active Distance Assist DISTRONIC



Cruise control lever

There are several ways to deactivate Active Distance Assist DISTRONIC:

► Briefly press the cruise control lever forwards ①.

or

► Brake, unless the vehicle is stationary.

When you deactivate Active Distance Assist DISTRONIC, the **Active Distance Assist Off** message appears on the multifunction display for approximately five seconds.

**i** The last speed stored remains until you switch off the engine.

**i** Active Distance Assist DISTRONIC is not deactivated if you depress the accelerator pedal. If you accelerate to overtake, Active Distance Assist DISTRONIC adjusts the vehicle's speed to the last speed stored after you have finished overtaking.

Active Distance Assist DISTRONIC is automatically deactivated if:

- you engage the electric parking brake or if the vehicle is automatically secured with the electric parking brake
- ESP® intervenes or you deactivate ESP®
- the transmission is in position **P**, **R** or **N**
- you pull the cruise control lever towards you in order to pull away and the front-passenger door is open
- you activate Active Parking Assist
- the vehicle is skidding

If Active Distance Assist DISTRONIC is deactivated automatically, you will hear a warning tone. The **Active Distance Assist Off**

message will appear on the multifunction display for approximately five seconds.

## Tips for driving with Active Distance Assist DISTRONIC

### General notes

The following contains descriptions of certain road and traffic conditions in which you must be particularly attentive. In such situations, brake if necessary. Active Distance Assist DISTRONIC will then be deactivated.

### Cornering, going into and coming out of a bend

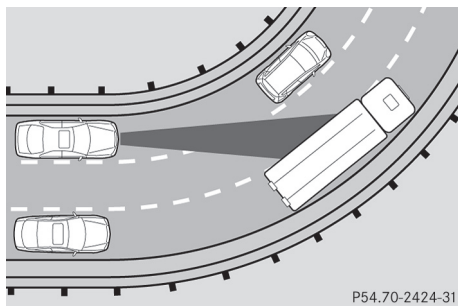

P54.70-2424-31

The ability of Active Distance Assist DISTRONIC to detect vehicles when cornering is limited. Your vehicle may brake unexpectedly or late.

### Vehicles traveling on a different line

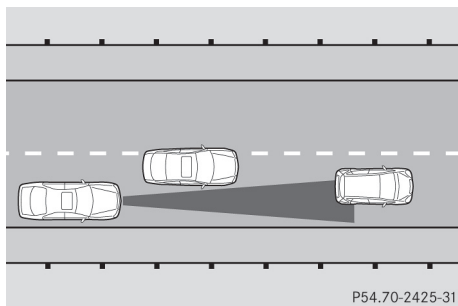

P54.70-2425-31

Active Distance Assist DISTRONIC may not detect vehicles that are not driving in the middle of their lane. The distance to the vehicle in front will be too short.

### Other vehicles changing lanes

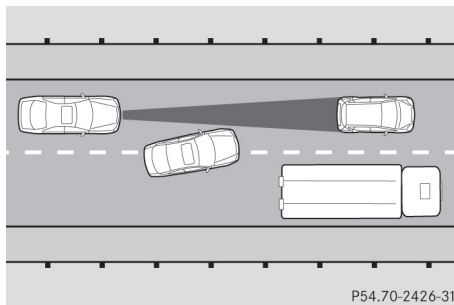

P54.70-2426-31

Active Distance Assist DISTRONIC has not detected the vehicle cutting in yet. The distance to this vehicle will be too short.

### Narrow vehicles

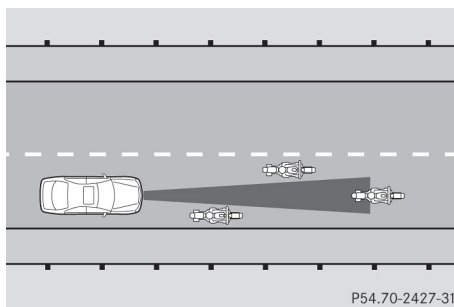

P54.70-2427-31

Active Distance Assist DISTRONIC has not yet detected the vehicle in front on the edge of the road because of its narrow width. The distance to the vehicle in front will be too short.

### Obstructions and stationary vehicles

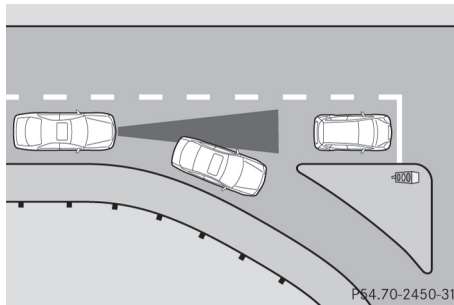

P54.70-2450-31

Active Distance Assist DISTRONIC does not brake for obstacles or stationary vehicles. If, for example, the detected vehicle turns a corner and an obstacle or stationary vehicle is



revealed, Active Distance Assist DISTRONIC will not brake for them.

### Crossing vehicles

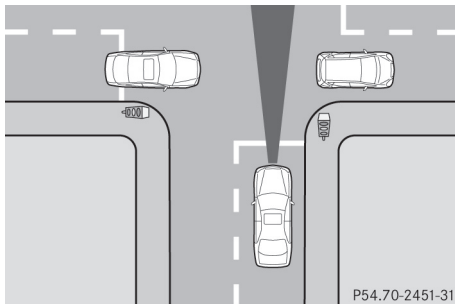

Active Distance Assist DISTRONIC may mistakenly detect vehicles that are crossing your lane.

If you activate Active Distance Assist DISTRONIC under the following conditions, the vehicle could pull away unintentionally:

- at traffic lights with crossing traffic, for example
- if there is a vehicle in front, after a crossing, with the HOLD function activated

### Active Distance Assist DISTRONIC with Active Steering Assist

#### General notes

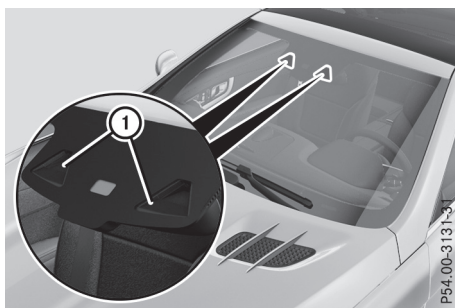

Active Distance Assist DISTRONIC with Active Steering Assist aids you in keeping the vehicle in the center of the driving lane by means of moderate steering interventions in a speed range from 0 - 125 mph (0 - 200 km/h).

It monitors lane markings and vehicles in front of your vehicle by means of camera system ① at the top of the windshield.

In a speed range from 0 - 37 mph (0 - 60 km/h), Active Steering Assist focuses on the vehicle in front, taking into account lane markings, e.g. when following vehicles in a traffic jam.

At speeds of more than 37 mph (60 km/h), Active Steering Assist focuses on clear lane markings (left and right), only focusing on the vehicle in front if detected lane markings are not present at speeds of up to 80 mph (130 km/h).

If these conditions are not present, Active Steering Assist cannot provide assistance.

Active Distance Assist DISTRONIC must be active in order for the function to be available.

#### Important safety notes

Active Distance Assist DISTRONIC with Active Steering Assist can neither reduce the risk of an accident if you fail to adapt your driving style, nor override the laws of physics. It cannot take into account road, weather or traffic conditions. Active Distance Assist DISTRONIC with Active Steering Assist is only an aid. You are responsible for the distance to the vehicle in front, for vehicle speed, for braking in good time and for staying in your lane.

Active Distance Assist DISTRONIC with Active Steering Assist does not detect road and traffic conditions and does not detect all road users. If you are following a vehicle which is driving towards the edge of the road, your vehicle could come into contact with the curb or other road boundaries. Be particularly aware of other road users, e.g. cyclists, that are directly next to your vehicle.

Obstacles such as traffic pylons on the lane or projecting into the lane are not detected.

An inappropriate steering intervention, e.g. after intentionally driving over a lane marking, can be corrected at any time if you steer slightly in the opposite direction.

Active Distance Assist DISTRONIC with Active Steering Assist cannot continuously keep your vehicle in lane. In some cases, the steering intervention is not sufficient to bring the vehicle back to the lane. In such cases, you must steer the vehicle yourself to ensure that it does not leave the lane.

The support provided by the system can be impaired if:

- there is poor visibility, e.g. due to insufficient illumination of the road, or due to snow, rain, fog or heavy spray
- there is glare, e.g. from oncoming traffic, the sun or reflection from other vehicles (e.g. if the road surface is wet)
- the windshield is dirty, fogged up, damaged or covered, for instance by a sticker, in the vicinity of the camera
- there are no lane markings, or several unclear lane markings are present, e.g. around construction sites
- the lane markings are worn away, dark or covered up, e.g. by dirt or snow
- the distance to the vehicle in front is too short and thus the lane markings cannot be detected
- the lane markings change quickly, e.g. lanes branch off, cross one another or merge
- the road is narrow and winding
- there are highly variable shade conditions on the roadway

The system is switched to passive and no longer assists you by performing steering interventions if:

- you actively change lanes
- you switch on the turn signal
- you take your hands off the steering wheel or do not steer for a prolonged period of time

- **i** After you have finished changing lanes, Active Steering Assist is automatically active once more.

Active Steering Assist cannot provide assistance:

- on very sharp corners
- when a loss of tire pressure or a defective tire has been detected and displayed

Observe the important safety notes on Active Distance Assist DISTRONIC (▷ page 156).

The steering interventions are carried out with a limited steering moment. The system requires the driver to keep his hands on the steering wheel and to steer himself.

If you do not steer yourself or if you take your hands off the steering wheel for a prolonged period of time, the system will first alert you with a visual warning. A steering wheel symbol

appears in the multifunction display. If you have still not started to steer and have not taken hold of the steering wheel after five seconds at the latest, a warning tone also sounds to remind you to take control of the vehicle. Active Steering Assist is then switched to passive. Active Distance Assist DISTRONIC remains active.

### Activating Active Steering Assist

- ▶ Select the Active Distance Assist DISTRONIC with Active Steering Assist function using the on-board computer (▷ page 198).  
The **Active Steering Assist On** message appears in the multifunction display. Active Steering Assist is activated.

### Information in the multifunction display



If Active Steering Assist is activated but not ready for a steering intervention, steering wheel symbol ① appears in gray. If the system provides you with support by means of steering interventions, symbol ① is shown in green.

### Deactivating Active Steering Assist

- ▶ Deactivate the Active Distance Assist DISTRONIC with Active Steering Assist function using the on-board computer (▷ page 198).  
The **Active Steering Assist Off** message appears in the multifunction display. Active Steering Assist is deactivated.

When Active Distance Assist DISTRONIC is deactivated or not available, Active Steering Assist is deactivated automatically.

## HOLD function

### General notes

The HOLD function can assist the driver in the following situations:

- When pulling away, especially on steep slopes
- When maneuvering on steep slopes
- When waiting in traffic

The vehicle is kept stationary without the driver having to depress the brake pedal.

The braking effect is canceled and the HOLD function deactivated when you depress the accelerator pedal to pull away.

### Important safety notes

#### WARNING

If the vehicle is only braked using the HOLD function, the vehicle may roll away in the following situations when you leave the vehicle:

- if there is a malfunction in the system or in the voltage supply
- if the HOLD function is deactivated by depressing the accelerator pedal or brake pedal, e.g. by a vehicle occupant

There is a risk of an accident.

Always deactivate the HOLD function and secure the vehicle against rolling away before you leave it.

**!** When Active Distance Assist DISTRONIC or the HOLD function is activated, the vehicle brakes automatically in certain situations.

To avoid damage to the vehicle, deactivate Active Distance Assist DISTRONIC and the HOLD function in the following or similar situations:

- when towing the vehicle
- in the car wash

Deactivating the HOLD function (▷ page 165).

### Activation conditions

You can activate the HOLD function if all of the following conditions are fulfilled:

- the vehicle is stationary.
- the engine is running or if it has been automatically switched off by the ECO start/stop function.
- the driver's door is closed or your seat belt is fastened.
- the electric parking brake is released.
- the transmission is in position **D**, **R** or **N**.
- Active Distance Assist DISTRONIC is deactivated

### Activating the HOLD function

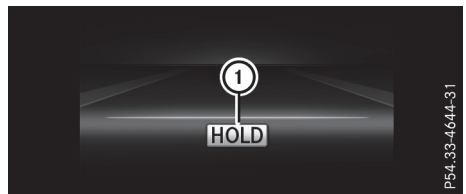

- ▶ Make sure that the activation conditions are met.
- ▶ Depress the brake pedal.
- ▶ Quickly depress the brake pedal further until ① appears in the multifunction display. The HOLD function is activated. You can release the brake pedal.

**i** If depressing the brake pedal the first time does not activate the HOLD function, wait briefly and then try again.

### Deactivating the HOLD function

The HOLD function is deactivated automatically if:

- you depress the accelerator and the transmission is in position **D** or **R**.
- the transmission is in position **P**.
- you depress the brake pedal again with a certain amount of pressure until **HOLD** disappears from the multifunction display.
- you secure the vehicle using the electric parking brake.
- you activate Active Distance Assist DISTRONIC.

- i** After a time, the electric parking brake secures the vehicle and relieves the service brake.

When the HOLD function is activated, the transmission is shifted automatically to position **P** if:

- the driver's seat belt is not fastened and the driver's door is open.
- the engine is switched off, unless it is automatically switched off by the ECO start/stop function.

The electric parking brake secures the vehicle automatically if the HOLD function is activated when the vehicle is stationary and:

- a system malfunction occurs
- the power supply is not sufficient

If a malfunction in the electric parking brake occurs, the transmission may also be shifted into position **P** automatically.

## RACE START

### Important safety notes

- i** RACE START must not be used on normal roads. RACE START must only be activated and used on dedicated road circuits, outside of public road use.
- i** RACE START is only available for Mercedes-AMG vehicles.

RACE START enables optimal acceleration from a standing start. For this, a suitably high-grip road surface is required and the vehicle and tires must be in good working order.

#### WARNING

If you use RACE START, individual tires may start to spin and the vehicle could skid. Depending on the selected ESP<sup>®</sup> mode, there is an increased risk of skidding and having an accident. Make sure that no persons, animals or obstacles are within range of the vehicle.

- i** Observe the safety notes on driving safety systems (▷ page 60).  
Be sure to read the safety notes and information on ESP<sup>®</sup> (▷ page 65).

### Activation conditions

You can activate RACE START if:

- the doors are closed.
- the engine is running and it has reached an operating temperature of approximately 160 °F (71 °C). This is the case when the oil temperature gage in the multifunction display is shown in white.
- the engine is running and the engine and transmission are at operating temperature. This is the case when the oil temperature gage in the multifunction display is shown in white (▷ page 202).
- ESP<sup>®</sup> is functioning correctly (▷ page 66)
- the drive program **S**, **S+** or **Race** is selected (▷ page 133)
- the steering wheel is in the straight-ahead position
- the vehicle is stationary and the brake pedal is depressed (left foot)
- the transmission is in position **D**

### Activating RACE START

- i** When manual mode (▷ page 141) is active, the transmission automatically shifts up in the RACE START drive program. This function supports maximum acceleration with RACE START. After going through an accelerating process once from a stationary position, this function is automatically deactivated.
- ▶ Depress the brake pedal with your left foot and keep it depressed.
- ▶ Pull and hold both steering wheel paddle shifters.
- ▶ The **RACE START Confirm: Paddle UP Cancel: Paddle DOWN** message appears in the multifunction display.
- ▶ Release both steering wheel paddle shifters.
- i** If the activation conditions are no longer fulfilled, RACE START is canceled. The **RACE START Canceled** message appears in the multifunction display.

► **To cancel:** pull the left-hand steering wheel paddle shifter (▷ page 141).

or

► **To confirm:** pull the right-hand steering wheel paddle shifter (▷ page 141). The **RACE START Available Depress gas pedal.** message appears in the multifunction display.

**i** If you do not depress the accelerator pedal within a few seconds, RACE START is canceled. The multifunction display shows the **RACE START Canceled** message.

► Depress the accelerator pedal completely, until the engine speed stops increasing. The **RACE START Release brake to start** message appears in the multifunction display.

**i** If you do not release the brake pedal within five seconds, RACE START is canceled. The **RACE START Canceled** message appears in the multifunction display.

► Take your foot off the brake, but keep the accelerator pedal depressed. The vehicle pulls away at maximum acceleration.

The **RACE START Active** message appears in the multifunction display.

RACE START is deactivated when the vehicle reaches a speed of approximately 30 mph (Canada: 50 km/h).

RACE START is deactivated immediately if you release the accelerator pedal during RACE START or if any of the activation conditions are no longer fulfilled. The **RACE START Not Possible See Operator's Manual** or **RACE START Canceled** message appears in the multifunction display.

**i** If RACE START is used repeatedly within a short period of time, it is only available again after the vehicle has been driven a certain distance.

## Adaptive damping system

### General notes

A suspension with the adaptive damping system provides improved driving comfort and continuously controls the calibration of the dampers. The damping characteristics adapt to the current operating and driving situation.

The damping is tuned individually to each wheel and depends on:

- your driving style, e.g. sporty
- the road surface conditions
- the selected drive program (▷ page 132).

### Selecting the Comfort or Economy drive programs



In the **Comfort** and **Economy** drive programs, the driving characteristics of your vehicle are more comfortable. Select one of these drive programs if you favor a more comfortable driving style. Also select these drive programs when driving fast on straight roads, e.g. on straight stretches of highway.

In urban traffic and stop-start traffic, drive program **C** is recommended.

► Press DYNAMIC SELECT button **1** repeatedly until the **Comfort** or **Economy** drive program is selected.

### Selecting Sport mode

The firmer setting of the suspension tuning in the **Sport** drive program ensures even better contact with the road. Select this drive program when employing a sporty driving style, e.g. on winding country roads.

► Press DYNAMIC SELECT button **1** as many times as necessary until the **Sport** drive program is selected.

### Selecting Sport Plus mode

The firmer suspension settings in the **Sport Plus** drive program ensure even better contact with the road. Select this mode when employing a sporty driving style, e.g. on winding coun-

try roads or, ideally, when driving on closed race circuits.

- ▶ Press DYNAMIC SELECT button ① repeatedly until the **Sport Plus** drive program is selected.

### Activating the driving dynamics display



Using the driving dynamics display in the multimedia system display, you can see the drive program you selected as well as additional information on the vehicle's operating state.

- ▶ Switch on the multimedia system. Further information can be found in the Digital Operator's Manual.
- ▶ Press button ①.  
The driving dynamics display appears in the multimedia system display.

The following information on the vehicle's operating status is displayed in the driving dynamics display:

- Drive program selected (▷ page 132)
- Accelerator pedal position shown in %
- Brake pedal position shown in %
- Steering angle
- Damping setting selected
- G-FORCE cross displaying longitudinal and lateral acceleration (only available in **Sport** or **Sport Plus** drive programs)

### Active Body Control ABC (except Mercedes-AMG vehicles)

#### Setting the vehicle level

##### General notes

The vehicle level can be set using the DYNAMIC SELECT button (▷ page 132) or the level button. The setting always corresponds to the last selected function.

In order to reduce fuel consumption and improve the driving dynamics, the vehicle is lowered as its speed increases. In the **Sport** and **Sport Plus** drive programs, it is lowered by up to 0.5 in (13 mm) compared to the normal vehicle level. In the **Comfort** and **CURVE** drive programs, it is lowered by up to 0.2 in (5 mm) compared to the normal vehicle level. As the speed is reduced, the vehicle is raised up to the set vehicle height.

Select the normal level for normal road surfaces and the raised level for driving with snow chains or on particularly poor road surfaces.

##### Important safety notes

##### WARNING

The vehicle is lowered slightly in the following situations:

- the SPORT suspension setting is selected at the normal vehicle level
- the engine is switched off

Persons in the vicinity of the wheel arch or the underbody may thus become trapped. There is a risk of injury.

Make sure that nobody is in the vicinity of the wheel arch or the underbody when you switch off the engine.



## Setting raised level

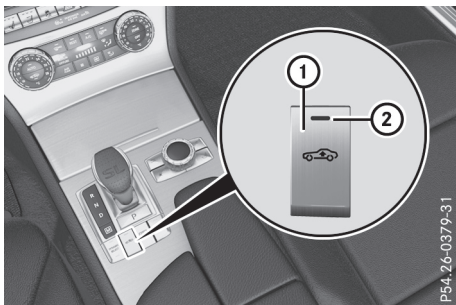

- ▶ Make sure that the engine is running or that it has been switched off by the ECO start/stop function.
- ▶ Make sure that a speed of 75 mph (120 km/h) is not exceeded.
- ▶ **If indicator lamp ② is not lit:** press button ①.  
If the engine has been switched off by the ECO start/stop function, it is now restarted. Indicator lamp ② lights up. The vehicle is raised by 1.2 in (31 mm).

## Setting the normal level

- ▶ Make sure that the engine is running or that it has been switched off by the ECO start/stop function.
- ▶ **If indicator lamp ② is lit:** press button ①. Indicator lamp ② goes out. The vehicle is adjusted to normal level

The "Raised level" setting is canceled if you:

- are driving faster than approximately 75 mph (120 km/h).
- drive for approximately three minutes at a speed over 50 mph (80 km/h).
- or switch to the drive program while the vehicle is in motion.

## Suspension tuning

### General notes

The electro-hydraulically controlled suspension features improved driving dynamics, driving safety and ride comfort. You can also choose between a sporty, a particularly sporty, a comfortable and a comfortable mode with curve tilting function (CURVE).

The suspension is continuously tuned to each wheel individually and depends on:

- the road surface condition, e.g. bumps
- the vehicle load
- the drive program selected

Each time you start the engine with the Smart-Key or the Start/Stop button, the **Comfort** drive program is activated. Further information about starting the engine (▷ page 127).

## Selecting Comfort mode



In the **Comfort** drive program, the driving characteristics of your vehicle are more comfortable. Select this mode if you favor a more comfortable driving style.

- ▶ Press DYNAMIC SELECT button ① as many times as necessary until the **Comfort** drive program is selected.

## Selecting Sport mode

The firmer setting of the suspension tuning in the **Sport** drive program ensures even better contact with the road. Select this mode if you favor a firmer suspension setting.

- ▶ Press DYNAMIC SELECT button ① as many times as necessary until the **Sport** drive program is selected.

## Selecting Sport Plus mode

The firmer setting of the suspension tuning in the **Sport Plus** drive program ensures even better contact with the road. Select this mode if you favor a firmer suspension setting.

- ▶ Press DYNAMIC SELECT button ① as many times as necessary until the **Sport Plus** drive program is selected.

### Selecting the CURVE setting

In the **CURVE** drive program, the curve tilting function is activated. The vehicle tilts by up to 2.65 degrees into bends. The tilt function and the comfort suspension tuning increase driving comfort in corners. **CURVE** is available in the speed range between 9 mph (15 km/h) and 112 mph (180 km/h). Select this mode on winding roads in particular. Outside this speed range, the **CURVE** drive program is the same as the **Comfort** drive program.

The curve tilting function monitors the road in front of your vehicle by means of a camera attached at the top of the windshield. This function is automatically active if you select the **CURVE** drive program. The system is operational at speeds of up to 112 mph (180 km/h).

► Press DYNAMIC SELECT button  as many times as necessary until the **CURVE** drive program is selected.

The system is deactivated if you select a different drive program.

The system may be impaired or may not function if:

- you are driving more slowly than 9 mph (15 km/h) or faster than 112 mph (180 km/h).
- the vehicle is fully laden.
- you drive with very high lateral acceleration.

### Activating the driving dynamics display



Using the driving dynamics display in the multimedia system display, you can see the drive program you selected as well as additional information on the vehicle's operating state.

► Switch on the multimedia system. Further information can be found in the Digital Operator's Manual.

► Press button .

The driving dynamics display appears in the multimedia system display.

The following information on the vehicle's operating status is displayed in the driving dynamics display:

- Drive program selected (► page 132)
- Accelerator pedal position shown in %
- Brake pedal position shown in %
- Steering angle
- Activity of the ABC spring struts
- Vehicle level display (► page 168)
- Level settings animation
- G-FORCE cross displaying longitudinal and lateral acceleration (only available in **Sport** or **Sport Plus** drive programs)

### Active Body Control (ABC) (Mercedes-AMG vehicles)

#### Setting the vehicle level

##### General notes

The vehicle level can be set using the DYNAMIC SELECT controller (► page 133) or the on-board computer (► page 171). The setting always corresponds to the last selected function.

In order to reduce fuel consumption and improve the driving dynamics, the vehicle is lowered as its speed increases. In the **Sport** and **Sport Plus** drive programs it is lowered by up to 0.5 in (13 mm), and in the **Comfort** drive program by up to 0.2 in (5 mm) compared to the normal vehicle level. As the speed is reduced, the vehicle is raised up to the set vehicle height.

Each time you start the engine with the Smart-Key or the Start/Stop button, the **Comfort** drive program is activated. For further information about starting the engine, see (► page 127).

Select the normal level for normal road surfaces and the raised level for driving with snow chains or on particularly poor road surfaces.

## Important safety notes

The vehicle is slightly lowered when the engine is switched off.







### WARNING

When the vehicle is being lowered, people could become trapped if their limbs are between the vehicle body and the wheels or underneath the vehicle. There is a risk of injury.

Make sure no one is underneath the vehicle or in the immediate vicinity of the wheel arches when the vehicle is being lowered.







## Setting raised level



- ▶ Make sure that the engine is running or that it has been switched off by the ECO start/stop function.
- ▶ Make sure that a speed of 75 mph (120 km/h) is not exceeded.
- ▶ **If symbol ② is not shown:** press  or  on the steering wheel to select the **DriveAssist** menu.
- ▶ Press the  or  button to select **Vehicle level**.
- ▶ Press the  button.  
The following message appears: ① **Vehicle level Press 'OK' to Raise**.
- ▶ Press the  button.  
If the engine has been switched off by the ECO start/stop function, it is now restarted. Symbol ② appears. The vehicle height is adjusted to raised level.

## Setting the normal level



- ▶ Make sure that the engine is running or that it has been switched off by the ECO start/stop function.
- ▶ **If symbol ② is shown:** press  or  on the steering wheel to select the **DriveAssist** menu.
- ▶ Press the  or  button to select **Vehicle level**.
- ▶ Press the  button.  
The following message appears: ① **Vehicle level Press 'OK' to Lower**.
- ▶ Press the  button.  
Icon ② is faded out. The vehicle is adjusted to normal level

The "Raised level" setting is canceled if you:

- are driving faster than approximately 75 mph (120 km/h).
- drive for approximately three minutes at a speed over 50 mph (80 km/h).
- or switch to the drive program while the vehicle is in motion.

## Suspension tuning

### General notes

The electro-hydraulically controlled suspension features improved driving dynamics, driving safety and ride comfort. You can also choose between a particularly sporty or a comfortable tuning.

The suspension is continuously tuned to each wheel individually and depends on:

- the road surface condition, e.g. bumps
- the vehicle load
- the drive program selected

Your selection remains saved even if you remove the key from the ignition lock.

Each time you start the engine with the Smart-Key or the Start/Stop button, the comfortable setting is activated. For further information about starting the engine, see (▷ page 127).

### Selecting sports tuning

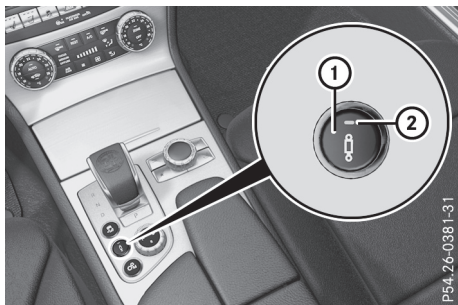

P54\_Z6-0381-31

The firmer setting of the suspension tuning in sports mode ensures even better contact with the road. Select this mode if you favor a firmer suspension setting.

- ▶ Make sure that the engine is running or that it has been switched off by the ECO start/stop function.
- ▶ **If indicator lamp ② is not lit:** press button ①. Indicator lamp ② lights up. Sports suspension tuning is selected. The **AMG Suspension System SPORT** message appears in the multifunction display.

### Selecting comfort tuning



P54\_Z6-0381-31

In comfort mode, the driving characteristics of your vehicle are more comfortable. Select this mode if you favor a more comfortable driving style.

- ▶ Make sure that the engine is running or that it has been switched off by the ECO start/stop function.
- ▶ **If indicator lamp ② is lit:** press button ①. Indicator lamp ② goes out. Comfortable suspension tuning is selected. The **AMG Suspension System COMFORT** message appears in the multifunction display.

### Activating the driving dynamics display in the COMAND display

Using the driving dynamics display in the multimedia system display, you can see the drive program you selected as well as additional information on the vehicle's operating status.

- ▶ Switch on COMAND. Further information can be found in the Digital Operator's Manual.

The following information on the vehicle's operating status is displayed in the driving dynamics display:

- Drive program selected (▷ page 133)
- Accelerator pedal position shown in %
- Brake pedal position shown in %
- Steering angle
- Vehicle level display (▷ page 170)
- Activity of the ABC spring struts
- Level settings animation
- G-FORCE cross to display longitudinal and lateral acceleration (only available in **Sport**, **Sport Plus** and **RACE** drive programs)
- Overrun mode animation

### Parking Assist PARKTRONIC

#### Important safety notes

Parking Assist PARKTRONIC is an electronic parking aid with ultrasound. It monitors the area around your vehicle using six sensors in the front bumper and six sensors in the rear bumper. Parking Assist PARKTRONIC visually and audibly indicates the distance between your vehicle and an object.

Parking Assist PARKTRONIC is only an aid. It is not a replacement for your attention to your immediate surroundings. You are always responsible for safe maneuvering, parking and

exiting a parking space. Make sure that there are no persons, animals or objects in the maneuvering area when you are maneuvering or parking.

**!** When parking, pay particular attention to objects above or below the sensors, such as flower pots or trailer drawbars. PARKTRONIC does not detect such objects when they are in the immediate vicinity of the vehicle. You could damage the vehicle or the objects.

The sensors may not detect snow and other objects that absorb ultrasonic waves.

Ultrasonic sources such as an automatic car wash, the compressed-air brakes on a truck or a pneumatic drill could cause PARKTRONIC to malfunction.

PARKTRONIC may not function correctly on uneven terrain.

Parking Assist PARKTRONIC is activated automatically when you:

- switch on the ignition
- shift the transmission to position **D**, **R** or **N**
- release the electric parking brake

Parking Assist PARKTRONIC is deactivated at speeds above 11 mph (18 km/h). It is reactivated at lower speeds.

### Range of the sensors

#### General notes

Parking Assist PARKTRONIC does not take into account obstacles located:

- below the detection range, such as persons, animals or objects
- above the detection range, e.g. overhanging loads, tail sections or loading ramps of trucks

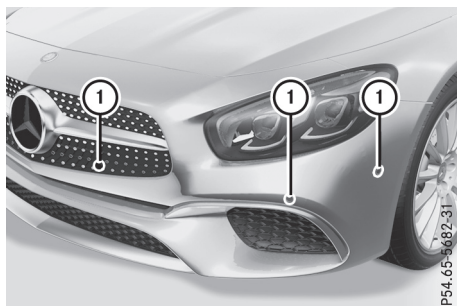

① Sensors in the front bumper, left-hand side (example)

The sensors must be free from dirt, ice or slush. They can otherwise not function correctly. Clean the sensors regularly, taking care not to scratch or damage them (> page 275).

#### Range

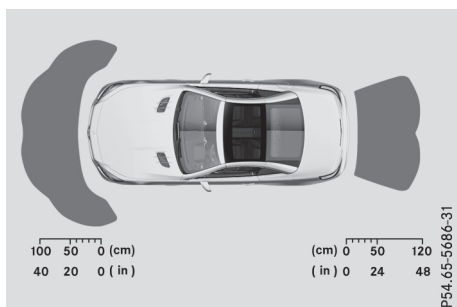
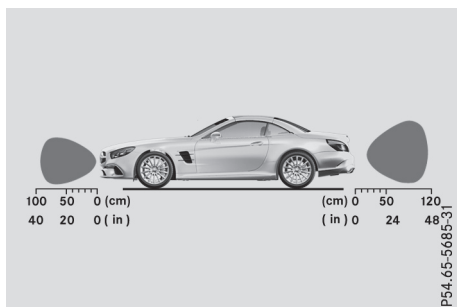

#### Front sensors

Center	Approx. 40 in (approx. 100 cm)
Corners	Approx. 24 in (approx. 60 cm)

P54-65-5682-31

P54-65-5685-31

P54-65-5686-31



## Rear sensors

Center	Approx. 48 in (approx. 120 cm)
Corners	Approx. 32 in (approx. 80 cm)

## Minimum distance

Center	Approx. 8 in (approx. 20 cm)
Corners	Approx. 6 in (approx. 15 cm)

If there is an obstacle within this range, the relevant warning displays light up and a warning tone sounds. If the distance falls below the minimum, the distance may no longer be shown.

## Warning displays

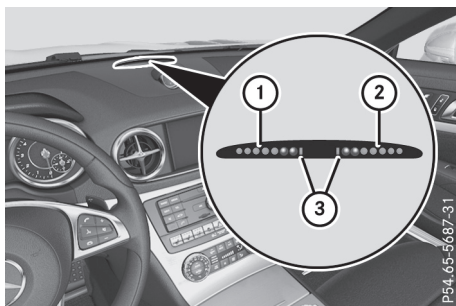

Warning display for the front area

- ① Segments on the left-hand side of the vehicle
- ② Segments on the right-hand side of the vehicle
- ③ Operational readiness segments

The warning displays show the distance between the sensors and the obstacle. The warning display for the front area is located on the dashboard above the center air vents. The warning display for the rear area is located on the cover behind the seats in the rear passenger compartment.

The warning display for each side of the vehicle is divided into five yellow and two red segments. If yellow operational readiness segments ③ light up, Parking Assist PARKTRONIC is operational.

The selected transmission position and the direction in which the vehicle is rolling determine which warning display is active when the engine is running.

Transmission position	Warning display
<b>D</b>	Front area active
<b>R</b> , <b>N</b> or the vehicle is rolling backwards	Rear and front areas active
<b>P</b>	No areas active

One or more segments light up as the vehicle approaches an obstacle, depending on the vehicle's distance from the obstacle. In addition, warning tones are issued.

When the distance to the obstacle is sufficient, you will hear an intermittent warning tone. The shorter the distance to the obstacle, the shorter the frequency of the intermittent warning tones becomes. When the minimum distance is reached, you hear a continuous warning tone.

## Deactivating/activating Parking Assist PARKTRONIC



- ① Deactivates/activates Parking Assist PARKTRONIC
- ② Indicator lamp

If indicator lamp ② lights up, Parking Assist PARKTRONIC is deactivated. Active Parking Assist is then also deactivated.

- i** Parking Assist PARKTRONIC is automatically activated when you turn the SmartKey to position ② in the ignition lock.



## Problems with Parking Assist PARKTRONIC

Problem	Possible causes/consequences and ► Solutions
<p>Only the red segments in the Parking Assist PARKTRONIC warning displays are lit. You also hear a warning tone for approximately two seconds.</p> <p>Parking Assist PARKTRONIC is deactivated after approximately five seconds and the indicator lamp in the Parking Assist PARKTRONIC button lights up.</p>	<p>Parking Assist PARKTRONIC has malfunctioned and has been deactivated.</p> <ul style="list-style-type: none"> <li>► If problems persist, have Parking Assist PARKTRONIC checked at a qualified specialist workshop.</li> </ul>
<p>Only the red segments in the Parking Assist PARKTRONIC warning displays are lit. Parking Assist PARKTRONIC is deactivated after approximately five seconds.</p>	<p>The Parking Assist PARKTRONIC sensors are dirty or there is interference.</p> <ul style="list-style-type: none"> <li>► Clean the Parking Assist PARKTRONIC sensors (▷ page 275).</li> <li>► Switch the ignition back on.</li> </ul> <p>The problem may be caused by an external source of radio or ultrasound waves.</p> <ul style="list-style-type: none"> <li>► Check to see if Parking Assist PARKTRONIC works at a different location.</li> </ul>

### Active Parking Assist

#### General notes

Active Parking Assist is an electronic parking aid with ultrasound. It measures the road on both sides of the vehicle. A parking symbol indicates a suitable parking space. Active steering intervention can assist you during parking and when exiting a parking space. You can also still use Parking Assist PARKTRONIC (▷ page 172).

#### Important safety notes

Active Parking Assist is merely an aid. It is not a replacement for your attention to your immediate surroundings. You are always responsible for safe maneuvering, parking and exiting a parking space. Make sure that no persons, animals or objects are in the path of your vehicle. When Parking Assist PARKTRONIC is deactivated, Active Parking Assist is also unavailable.

#### WARNING

While parking or pulling out of a parking space, the vehicle swings out and can drive onto areas of the oncoming lane. This could cause you to collide with other road users or objects. There is a risk of an accident.

Pay attention to other road users or objects. Stop the vehicle if necessary or cancel the Active Parking Assist parking procedure.

#### WARNING

While parking or pulling out of a parking space, the vehicle swings out and can drive onto areas of the oncoming lane. This could cause you to collide with other road users or objects. There is a risk of an accident.

Pay attention to other road users or objects. Stop the vehicle if necessary or cancel the

parking procedure with the Parking Package with rear view camera.

**!** If they cannot be avoided, drive over obstacles such as curbs slowly and at an obtuse angle. Otherwise, you may damage the wheels or tires.

Active Parking Assist may also show parking spaces which are not suitable for parking, for example:

- where parking or stopping is prohibited
- in front of driveways or entrances and exits
- on unsuitable surfaces

Parking tips:

- on narrow roads, drive as close to the parking space as possible
- parking spaces that are littered or overgrown might be identified or measured incorrectly
- parking spaces that are partially occupied by trailer drawbars might not be identified as such or be measured incorrectly
- snowfall or heavy rain may lead to a parking space being measured inaccurately
- pay attention to the warning messages of Parking Assist PARKTRONIC during the parking procedure (▷ page 174)
- you can intervene in the steering procedure to correct it at any time. Active Parking Assist will then be canceled
- when transporting a load which protrudes from your vehicle, you should not use Active Parking Assist
- never use Active Parking Assist when snow chains are installed
- make sure that the tire pressures are always correct. This has a direct influence on the parking characteristics of the vehicle

Use Active Parking Assist for parking spaces:

- parallel or at right angles to the direction of travel
- on straight roads, not bends
- on the same level as the road, e.g. not on the pavement

### Detecting parking spaces

Objects located above the detection range of Active Parking Assist will not be detected when the parking space is measured. These

are not taken into account when the parking procedure is calculated, e.g. overhanging loads, tail sections or loading ramps of trucks. Active Parking Assist may therefore guide you into the parking space too early.

#### WARNING

If there are objects above the detection range:

- the Parking Package with rear view camera may steer too early
- the vehicle may not stop in front of these objects

This could cause a collision. There is a risk of an accident.

If objects are located above the detection range, stop and deactivate the Parking Package with rear view camera.

Further information about the detection range (▷ page 173).

Active Parking Assist does not assist you parking in spaces at right angles to the direction of travel if:

- ▶ two parking spaces are located directly next to one another
- ▶ the parking space is directly next to a low obstacle such as a low curb
- ▶ you park forwards

Active Parking Assist does not assist you parking in spaces that are parallel or at right angles to the direction of travel if:

- the parking space is on a curb
- the system reads the parking space as being blocked, for example by foliage or grass paving blocks
- the area is too small for the vehicle to maneuver into
- the parking space is bordered by an obstacle, e.g. a tree, a post or a trailer

#### WARNING

If there are objects above the detection range:

- Active Parking Assist may steer too early
- the vehicle may not stop in front of these objects

This could cause a collision. There is a risk of an accident.

If objects are located above the detection range, stop and deactivate Active Parking Assist.

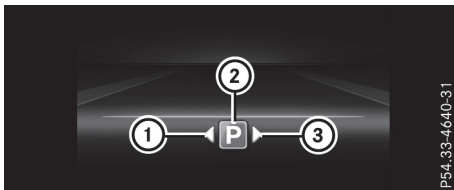

- ① Detected parking space on the left
- ② Parking symbol
- ③ Detected parking space on the right

Active Parking Assist is switched on automatically when driving forwards. The system is operational at speeds of up to approximately 22 mph (35 km/h). While in operation, the system independently locates and measures parking spaces on both sides of the vehicle.

Active Parking Assist will only detect parking spaces:

- parallel or at right angles to the direction of travel
- parallel to the direction of travel and at least 59 in (1.5 m) wide
- parallel to the direction of travel and at least 39.5 in (1.0 m) longer than your vehicle
- at right angles to the direction of travel and at least 39.5 in (1.0 m) wider than your vehicle

When driving at speeds below 19 mph (30 km/h), you will see parking symbol ② as a status indicator in the instrument cluster. When a parking space has been detected, an arrow towards the right or the left also appears. By default, Active Parking Assist only displays parking spaces on the front-passenger side. Parking spaces on the driver's side are displayed as soon as the turn signal on the driver's side is activated. When parking on the driver's side, this must remain activated until you confirm the use of Active Parking Assist by pressing the **OK** button on the multifunction steering wheel. The system automatically determines whether the parking space is parallel or at right angles to the direction of travel.

A parking space is displayed while you are driving past it, and until you are approximately 50 ft (15 m) away from it.

## Parking

### ⚠ WARNING

Active Parking Assist only supports you with active steering intervention. If you do not apply the brakes yourself, there is the risk of an accident.

Always apply the brakes yourself while maneuvering and parking.

### ⚠ WARNING

The Parking Package with rear view camera only supports you with active steering intervention. If you do not apply the brakes yourself, there is the risk of an accident.

Always apply the brakes yourself while maneuvering and parking.

- ▶ Stop the vehicle when the parking space symbol shows the desired parking space in the instrument cluster.
  - ▶ Shift the transmission to position **R**. The **Start Parking Assist? Yes: OK No: [↔]** message appears in the multifunction display.
  - ▶ **To cancel the procedure:** press the **[↔]** button on the multifunction steering wheel or pull away.
- or
- ▶ **To park using Active Parking Assist:** press the **OK** button on the multifunction steering wheel. The **Parking Assist Active Accelerate and Brake Observe Surroundings** message appears in the multifunction display.
  - ▶ Let go of the multifunction steering wheel.
  - ▶ Back up the vehicle, being ready to brake at all times. When backing up, drive at a speed below approximately 6 mph (10 km/h). Oth-

erwise, Active Parking Assist will be canceled.

- ▶ Stop as soon as Parking Assist PARKTRONIC sounds the continuous warning tone, if not before. Maneuvering may be required in tight parking spaces.

The **Parking Assist Active Select D Observe Surroundings** message appears in the multifunction display.

- ▶ Shift the transmission to position **[D]** while the vehicle is stationary. Active Parking Assist immediately steers in the other direction.

The **Parking Assist Active Accelerate and Brake Observe Surroundings** message appears in the multifunction display.

- ❗ You will achieve the best results by waiting for the steering procedure to complete before pulling away.
- ▶ Drive forwards and be ready to brake at all times.
- ▶ Stop as soon as Parking Assist PARKTRONIC sounds the continuous warning tone, if not before.

The **Parking Assist Active Select R Observe Surroundings** message appears in the multifunction display.

As soon as the parking procedure is complete, the **Active Parking Assist Finished** message appears on the multifunction display and you hear a tone. The vehicle is now parked.

Active Parking Assist no longer supports you with steering interventions. When Active Parking Assist is finished, you must steer again yourself. Parking Assist PARKTRONIC is still available.

Parking tips:

- The way your vehicle is positioned in the parking space after parking is dependent on various factors. These include the position and shape of the vehicles parked in front and behind it and the conditions of the location. It may be the case that Active Parking Assist guides you too far into a parking space, or not far enough into it. In some cases, it may also lead you across or onto

the curb. If necessary, cancel the parking procedure with Active Parking Assist.



- You can also preselect transmission position **[D]**. The vehicle redirects and does not drive as far into the parking space. Should the transmission change take place too early, the parking procedure is canceled. A sensible parking position can no longer be achieved from this position.

## Exiting a parking space

In order that Active Parking Assist can support you when exiting the parking space:

- the border of the parking space must be high enough at the front and the rear. A curb is too small, for example.
- the border of the parking space must not be too wide. Your vehicle can be maneuvered into a position at a maximum of 45° to the starting position in the parking space.
- a maneuvering distance of at least 3.3 ft (1.0 m) must be available.

Active Parking Assist can only assist you with exiting a parking space if you have parked the vehicle parallel to the direction of travel using Active Parking Assist.

- ▶ Start the engine.
- ▶ Release the electric parking brake.
- ▶ Switch on the turn signal in the direction you will drive out of the parking space.
- ▶ Shift the transmission to position **[D]** or **[R]**. The **Start Parking Assist? Yes: OK No: ** message appears in the multifunction display.
- ▶ **To cancel the procedure:** press the **** button on the multifunction steering wheel or pull away.
  - or
- ▶ **To exit a parking space using Active Parking Assist:** press the **[OK]** button on the multifunction steering wheel. The **Parking Assist Active Accelerate and Brake Observe Surroundings** message appears in the multifunction display.
- ▶ Let go of the multifunction steering wheel.
- ▶ Pull away, being ready to brake at all times. Do not exceed a maximum speed of approximately 6 mph (10 km/h) when exiting a parking space. Otherwise, Active Parking Assist will be canceled.

► Depending on the message or as required, shift the transmission to position **D** or **R** when the vehicle is stationary. Active Parking Assist immediately steers in the other direction. The **Parking Assist Active Accelerate and Brake Observe Surroundings** message appears in the multifunction display.

**i** You will achieve the best results by waiting for the steering procedure to complete before pulling away.

If you back up after activation, the steering wheel is moved to the straight-ahead position.

► Drive forwards and reverse as prompted by the Parking Assist PARKTRONIC warning displays, several times if necessary.

Once you have exited the parking space completely, the steering wheel is moved to the straight-ahead position. You hear a tone and the **Active Parking Assist Finished** message appears on the multifunction display. You will then have to steer and merge into traffic on your own. Parking Assist PARKTRONIC is still available. You can take over the steering before the vehicle has exited the parking space completely. This is useful, for example when you recognize that it is already possible to pull out of the parking space.

### Canceling Active Parking Assist

You can cancel Active Parking Assist at any time.

► Stop the movement of the multifunction steering wheel or steer yourself. Active Parking Assist will be canceled at once. The **Active Parking Assist Canceled** message appears in the multifunction display.

or

► Press the "Parking Assist PARKTRONIC" button on the center console (▷ page 174). Parking Assist PARKTRONIC is switched off and Active Parking Assist is immediately canceled. The **Active Parking Assist Canceled** message appears in the multifunction display.

Active Parking Assist is canceled automatically if:

- parking using Active Parking Assist is no longer possible
- you are driving faster than 6 mph (10 km/h)
- a wheel spins, ESP® intervenes or fails. The  ESP® warning lamp lights up in the instrument cluster.

A warning tone sounds. The parking symbol disappears and the **Active Parking Assist Canceled** message appears in the multifunction display.

When Active Parking Assist is canceled, you must always steer again yourself.

### Reversing camera

#### General notes

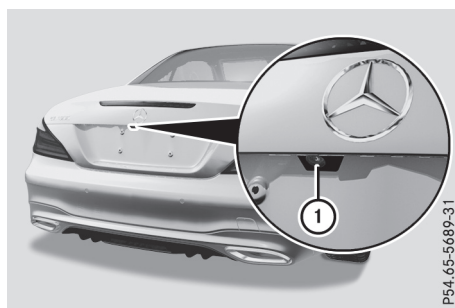

Rear view camera ① is an optical parking and maneuvering aid. It shows the area behind your vehicle with guide lines in the multimedia system.

The area behind the vehicle is displayed as a mirror image, as in the rear view mirror.

**i** The text shown in the multimedia system display depends on the language setting. The following are examples of rear view camera displays in the multimedia system.

### Important safety notes

The rear view camera is only an aid. It is not a replacement for your attention to your immediate surroundings. You are always responsible for safe maneuvering and parking. Make sure that there are no persons, animals or objects in the maneuvering area when you are maneuvering or parking.

Under the following circumstances, the rear view camera will not function, or will function in a limited manner:

- if the trunk lid is open
- in heavy rain, snow or fog
- at night or in very dark places
- if the camera is exposed to very bright light
- if the area is lit by fluorescent bulbs or LED lighting (the display may flicker)
- if there is a sudden change in temperature, e.g. when driving into a heated garage in winter
- if the camera lens is dirty or obstructed. Observe the notes on cleaning (▷ page 275)
- if the rear of your vehicle is damaged. In this case, have the camera position and setting checked at a qualified specialist workshop.

The field of vision and other functions of the rear view camera may be restricted due to additional accessories on the rear of the vehicle (e.g. license plate holder, bicycle rack).

On vehicles with height-adjustable chassis, leaving the standard height can result in inaccuracies in the guide lines, depending on technical conditions.

- i** The contrast of the display may be affected by the sudden presence of sunlight or other light sources, e.g. when exiting a garage. Pay particular attention in this situation.
- i** If usability is severely restricted, e.g. due to pixel errors, have the display repaired or replaced.

### Activating/deactivating the rear view camera

- ▶ **To activate:** make sure that the SmartKey is in position **2** in the ignition lock.
- ▶ Make sure that the **Activation by R gear** function is selected in the multimedia system; see the Digital Operator's Manual.
- ▶ Engage reverse gear. The multimedia system shows the area behind the vehicle with guide lines. The image from the rear view camera is available throughout the maneuvering process.

**To deactivate:** the rear view camera deactivates if you shift the transmission to position **P**, or after driving forwards a short distance.

The inner segments of the warning indicator are displayed in red if there is a complete system failure. The indicator lamp in the PARKTRONIC button lights up.

If the system fails at the rear of the vehicle:

- the rear segments are shown in red when backing up.
- the rear segments are hidden when driving forwards.

### Displays in the multimedia system

The rear view camera may show a distorted view of obstacles, show them incorrectly or not at all. The rear view camera does not show objects in the following positions:

- very close to the rear bumper
- under the rear bumper
- in close range above the handle on the trunk lid

**!** Objects not at ground level may appear to be further away than they actually are, e.g.:

- the bumper of a parked vehicle
- the drawbar of a trailer
- the ball coupling of a trailer tow hitch
- the rear section of an HGV
- a slanted post

Use the guidelines only for orientation.

Approach objects no further than the bottom-most guideline.

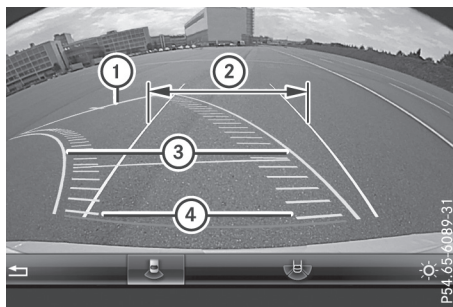

- ① Yellow guide line at a distance of approximately 13 ft (4.0 m) from the rear area
- ② White guide line without steering input – vehicle width including the exterior mirrors (static)



- ③ Yellow guide line for the vehicle width including the exterior mirrors, at the current steering wheel angle (dynamic)
- ④ Yellow lane marking the course the tires will take at the current steering wheel angle (dynamic)

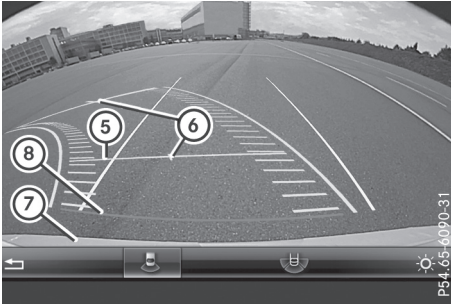

- ⑤ Yellow guide line at a distance of approximately 3 ft (1.0 m) from the rear area
- ⑥ Vehicle center axle (marker assistance)
- ⑦ Bumper
- ⑧ Red guide line at a distance of approximately 12 in (0.30 m) from the rear area

The guide lines are shown when the transmission is in position **R**.  
 The distance specifications only apply to objects that are at ground level.



- ① Front warning display
- ② Additional measurement operational readiness indicator for the Parking Package with rear view camera
- ③ Rear warning display

**Vehicles with the Parking Package with rear view camera:** when the Parking Package with rear view camera is operational (▷ page 173), additional measurement operational readiness indicator ② appears in the multimedia system. If the Parking Package

with rear warning displays are active or light up, warning displays ① and ③ are also active or light up correspondingly in the multimedia system.

### "Reverse parking" function

#### Backing up straight into a parking space without steering input

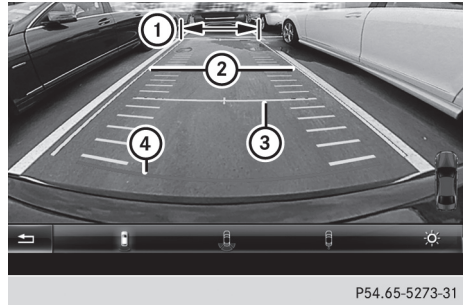

- ① White guide line without steering input – vehicle width including the exterior mirrors (static)
- ② Yellow guide line for the vehicle width including the exterior mirrors, at the current steering wheel angle (dynamic)
- ③ Yellow guide line at a distance of approximately 3 ft (1.0 m) from the rear area
- ④ Red guide line at a distance of approximately 12 in (0.30 m) from the rear area

- ▶ Make sure that the rear view camera is activated (▷ page 180). The lane and the guide lines are shown.
- ▶ With the help of white guide line ①, check whether the vehicle will fit into the parking space.
- ▶ Using white guide line ① as a guide, carefully back up until you reach the end position. Red guide line ④ is then at the end of the parking space. The vehicle is almost parallel in the parking space.

### Reverse perpendicular parking with steering input

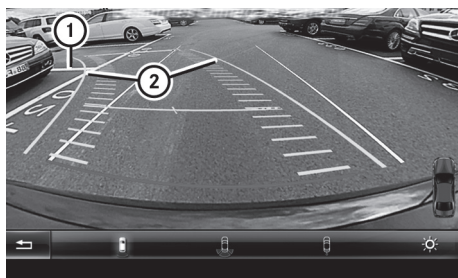

P54.65-5274-31

- ① Parking space marking
- ② Yellow guide line for the vehicle width including the exterior mirrors, at the current steering wheel angle (dynamic)
- ▶ Drive past the parking space and bring the vehicle to a standstill.
- ▶ Make sure that the rear view camera is activated (▶ page 180). The lane and the guide lines are shown.
- ▶ While the vehicle is at a standstill, turn the steering wheel in the direction of the parking space until yellow guide line ② reaches parking space marking ①.
- ▶ Maintain the steering input and reverse carefully.

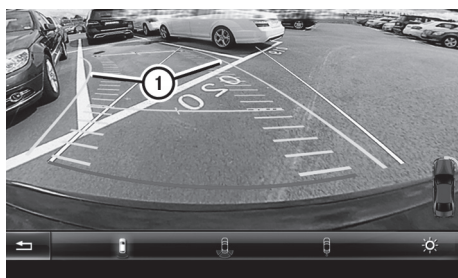

P54.65-5275-31

- ① Yellow guide line for the vehicle width including the exterior mirrors, at the current steering wheel angle (dynamic)
- ▶ Stop the vehicle when it is almost exactly in front of the parking space. The white lane should be as close to parallel with the parking space marking as possible.

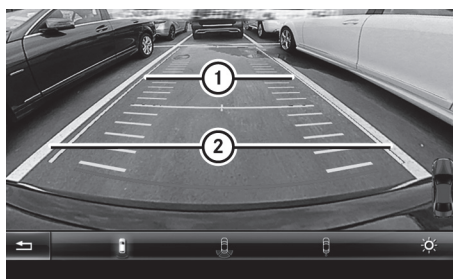

P54.65-5276-31

- ① White guide line at the current steering input
- ② Parking space marking
- ▶ Turn the steering wheel to the center position while the vehicle is stationary.

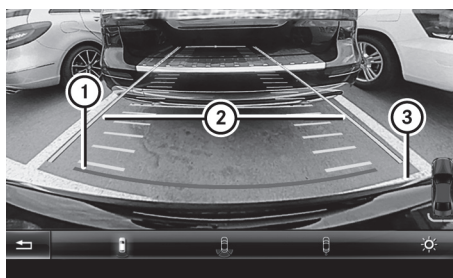

P54.65-5277-31

- ① Red guide line at a distance of approximately 12 in (0.30 m) from the rear area
- ② White guide line without steering input
- ③ End of parking space
- ▶ Back up carefully until you have reached the final position. Red guide line ① is then at end of parking space ③. The vehicle is almost parallel in the parking space.

## 180° view

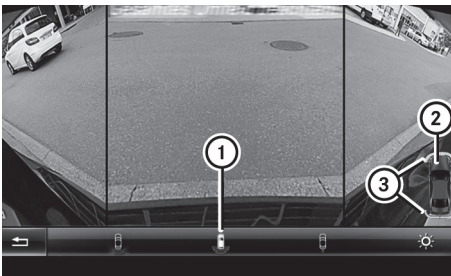

P54.65-5269-31

- ① Symbol for the 180° view function
- ② Your vehicle
- ③ Warning displays for the Parking Package with rear view camera

You can also use the rear view camera to select a 180° view.

When the Parking Package with rear view camera is operational (▷ page 173), a symbol for your own vehicle appears in the multimedia system. If the Parking Package with rear view camera warning displays are active, warning displays ③ light up in the multimedia system in yellow or red accordingly.

## ATTENTION ASSIST

### General notes

ATTENTION ASSIST helps you during long, monotonous journeys, such as on highways. It is active in the 37 mph (60 km/h) to 125 mph (200 km/h) range. If ATTENTION ASSIST detects typical indicators of fatigue or increasing lapses in concentration on the part of the driver, it suggests you take a break.

### Important safety notes

ATTENTION ASSIST is only an aid to the driver. It might not always recognize fatigue or increasing inattentiveness in time or fail to recognize them at all. The system is not a substitute for a well-rested and attentive driver.

The functionality of ATTENTION ASSIST is restricted and warnings may be delayed or not occur at all:

- if the length of the journey is less than approximately 30 minutes
- if the road condition is poor, e.g. if the surface is uneven or if there are potholes
- if there is a strong side wind
- if you have adopted a sporty driving style with high cornering speeds or high rates of acceleration
- if you are predominantly driving slower than 37 mph (60 km/h) or faster than 125 mph (200 km/h)
- if you are driving with the Steering Assist of Active Distance Assist DISTRONIC activated
- if the time has been set incorrectly
- in active driving situations, such as when you change lanes or change your speed

The attention level evaluation is deleted and restarts when the journey is continued, if:

- you switch off the engine
- you take off your seat belt and open the driver's door, e.g. for a change of drivers or to take a break

## Displaying the attention level



P54.33-3863-31

You can have current status information displayed in the assistance menu (▷ page 197) of the on-board computer.

- ▶ Select the Assistance display for ATTENTION ASSIST using the on-board computer (▷ page 198).

The following information is displayed:

- the length of the journey since the last break.
- the attention level determined by ATTENTION ASSIST, displayed in a bar display in five levels from high to low.
- if ATTENTION ASSIST is unable to calculate the attention level and cannot output a warning, the **System suspended** message appears. The bar display then changes the display, e.g. if you are driving at a speed below 37 mph (60 km/h) or above 125 mph (200 km/h).

### Activating ATTENTION ASSIST

- ▶ Activate ATTENTION ASSIST using the on-board computer (> page 198). The system determines the attention level of the driver depending on the setting selected:

**Standard selected:** the sensitivity with which the system determines the attention level is set to normal.

**Sensitive selected:** the sensitivity is set higher. The attention level detected by ATTENTION ASSIST is adapted accordingly and the driver is warned earlier.

When ATTENTION ASSIST is deactivated, the  symbol and OFF appear in the multifunction display in the assistance display when the engine is running.

When ATTENTION ASSIST has been deactivated, it is automatically reactivated after the engine has been stopped. The sensitivity selected corresponds to the last selection activated (standard/sensitive).

### Warning in the multifunction display

If fatigue or increasing lapses in concentration are detected, a warning appears in the multifunction display: **Attention Assist: Take a break!**

In addition to the message shown in the multifunction display, you will then hear a warning tone.

- ▶ If necessary, take a break.
- ▶ Confirm the message by pressing the  button on the steering wheel.

On long journeys, take regular breaks in good time to allow yourself to rest. If you do not

take a break, you will be warned again after 15 minutes at the earliest. The precondition for this is that ATTENTION ASSIST still detects typical indicators of fatigue or increasing lapses in concentration.

**Vehicles with COMAND:** if a warning is issued in the multifunction display, a service station search is performed in COMAND. You can select a service station and navigation to this service station will then begin. This function can be activated and deactivated in COMAND.

### Active Driving Assistance package

#### General notes

The Active Driving Assistance package consists of Active Distance Assist DISTRONIC (> page 156), Active Steering Assist, Active Blind Spot Assist (> page 184) and Active Lane Keeping Assist (> page 187).

#### Active Blind Spot Assist

##### General notes

Active Blind Spot Assist monitors the areas on either side of the vehicle that are not directly visible to the driver with two lateral, rear-facing radar sensors. A warning lamp lights up in the exterior mirrors and draws your attention to vehicles detected in the monitored area. If you then switch on the corresponding turn signal to change lane, you will also receive an optical and audible warning. If a risk of lateral collision is detected, corrective braking may help you avoid a collision. Before a course-correcting brake application, Active Blind Spot Assist evaluates the space in the direction of travel and at the sides of the vehicle. For this, Active Blind Spot Assist uses the forward-facing radar sensors.

Active Blind Spot Assist supports you from a speed of approximately 20 mph (30 km/h).

##### Important safety notes

Active Blind Spot Assist is only an aid and is not a substitute for attentive driving.

## WARNING

Active Blind Spot Assist does not react to:

- vehicles overtaken too closely on the side, placing them in the blind spot area
- vehicles which approach with a large speed differential and overtake your vehicle

As a result, Active Blind Spot Assist may neither give warnings nor intervene in such situations. There is a risk of an accident.

Always observe the traffic conditions carefully, and maintain a safe lateral distance.

**i** USA only: This device has been approved by the FCC as a "Vehicular Radar System". The radar sensor is intended for use in an automotive radar system only. Removal, tampering, or altering of the device will void any warranties, and is not permitted by the FCC. Do not tamper with, alter, or use in any non-approved way.

Any unauthorized modification to this device could void the user's authority to operate the equipment.

**i** Canada only: This device complies with RSS-210 of Industry Canada. Operation is subject to the following two conditions:

1. This device may not cause interference, and
2. This device must accept any interference received, including interference that may cause undesired operation of the device.

Removal, tampering, or altering of the device will void any warranties, and is not permitted. Do not tamper with, alter, or use in any non-approved way.

Any unauthorized modification to this device could void the user's authority to operate the equipment.

## Radar sensors

The radar sensors for Active Blind Spot Assist are integrated in the rear bumper and in the radiator trim. Make sure that the bumpers and radiator trim are free from dirt, ice and slush. The rear sensors must not be covered, for example by cycle racks or overhanging cargo. Following a severe impact or in the event of damage to the bumpers, have the function of the radar sensors checked at a qualified spe-

cialist workshop. Active Blind Spot Assist may otherwise no longer work properly.

## Monitoring area

### WARNING

Active Blind Spot Assist does not detect all traffic situations and road users. There is a risk of an accident.

Always make sure that there is sufficient distance on the side for other traffic or obstacles.

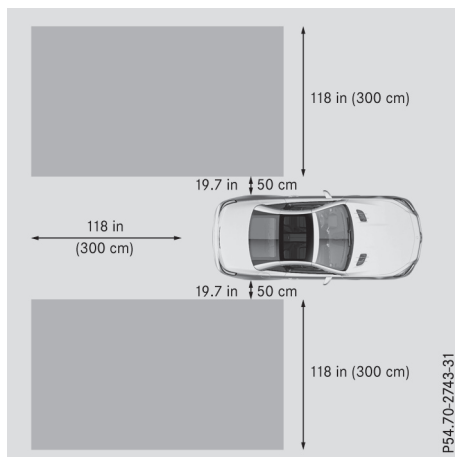

Active Blind Spot Assist monitors the area up to 10 ft (3.0 m) behind your vehicle and directly next to your vehicle, as shown in the diagram.

The detection of obstacles can be impaired in the case of:

- there is dirt on the sensors or anything else covering the sensors
- poor visibility, e.g. due to rain, snow or spray

Vehicles in the monitoring range are then not indicated.

Active Blind Spot Assist may not detect narrow vehicles, such as motorcycles or bicycles, or may only detect them too late.

If the lanes are narrow, vehicles driving in the lane beyond the lane next to your vehicle may be indicated, especially if the vehicles are not driving in the middle of their lane. This may be the case if there are vehicles driving at the inner edge of their lanes.



Due to the nature of the system:

- warnings may be issued in error when driving close to crash barriers or similar solid lane borders.
- warnings may be interrupted when driving alongside particularly long vehicles, e.g. trucks, for a prolonged time.

### Indicator and warning display

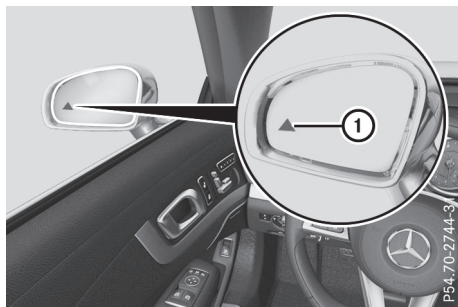

#### ① Yellow indicator lamp/red warning lamp

Active Blind Spot Assist is not active at speeds below approximately 20 mph (30 km/h). Vehicles in the monitoring range are then not indicated.

When Active Blind Spot Assist is activated, indicator lamp ① in the exterior mirrors lights up yellow at speeds of up to 20 mph (30 km/h). At speeds above 20 mph (30 km/h), the indicator lamp goes out and Active Blind Spot Assist is operational.

If a vehicle is detected within the monitoring range at speeds above approximately 20 mph (30 km/h), warning lamp ① on the corresponding side lights up red. This warning always occurs when a vehicle enters the monitoring range from behind or from the side. When you overtake a vehicle, the warning only occurs if the difference in speed is less than 7 mph (12 km/h).

The yellow indicator lamp goes out if reverse gear is engaged. In this event, Active Blind Spot Assist is no longer active.

The brightness of the indicator/warning lamps is adjusted automatically according to the ambient light.

### Visual and acoustic collision warning

If you switch on the turn signals to change lanes and a vehicle is detected in the side monitoring range, you receive a visual and acoustic collision warning. You will then hear a

double warning tone and red warning lamp ① flashes. If the turn signal remains on, detected vehicles are indicated by the flashing of red warning lamp ①. There are no further warning tones.

### Course-correcting brake application

If Active Blind Spot Assist detects a risk of a lateral collision in the monitoring range, a course-correcting brake application is carried out. This is meant to assist you in avoiding a collision.

#### WARNING

A course-correcting brake application cannot always prevent a collision. There is a risk of an accident.

Always steer, brake or accelerate yourself, especially if Active Blind Spot Assist warns you or makes a course-correcting brake application. Always maintain a safe distance at the sides.

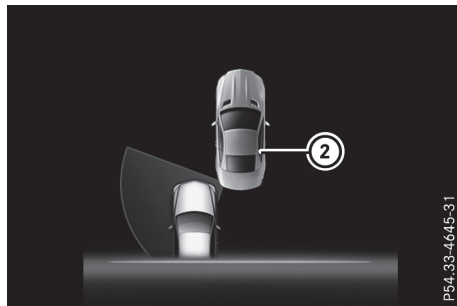

If a course-correcting brake application occurs, red warning lamp ① flashes in the exterior mirror and a dual warning tone sounds. In addition, display ② underlining the danger of a side collision appears in the multi-function display.

In very rare cases, the system may make an inappropriate brake application. A course-correcting brake application may be interrupted at any time, e.g. if you steer slightly in the opposite direction or depress the accelerator pedal more firmly.

The course-correcting brake application is available in the speed range between 20 mph (30 km/h) and 120 mph (200 km/h).



Either no braking application, or a course-correcting brake application adapted to the driving situation occurs if:

- there are vehicles or obstacles, e.g. crash barriers, located on both sides of your vehicle.
- a vehicle approaches you too closely at the side.
- you have adopted a sporty driving style with high cornering speeds.
- you clearly brake or accelerate.
- a driving safety system intervenes, e.g. ESP® or PRE-SAFE® Brake.
- ESP® is switched off.
- a loss of tire pressure or a defective tire is detected.

### Switching on Active Blind Spot Assist

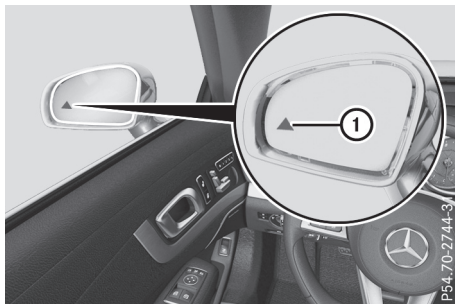

- ▶ Make sure that Active Blind Spot Assist is activated (▷ page 199).
- ▶ Turn the SmartKey to position **2** in the ignition lock.  
Warning lamps **1** in the exterior mirrors light up red for approximately 1.5 seconds and then turn yellow.

## Active Lane Keeping Assist

### General notes

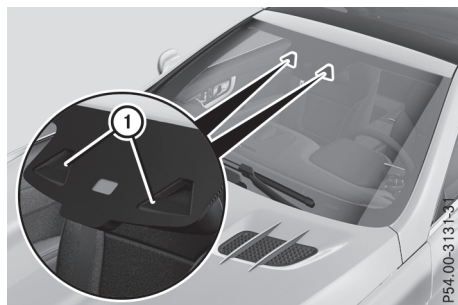

Active Lane Keeping Assist monitors the area in front of your vehicle by means of multifunction camera **1** at the top of the windshield. Various areas to the front, rear and side of your vehicle are also monitored with the aid of the radar sensor system. Active Lane Keeping Assist detects lane markings on the road and can warn you before you leave your lane unintentionally. If you do not react to the warning, a lane-correcting application of the brakes can bring the vehicle back into the original lane.

This function is available in a speed range between 40 mph and 120 mph (60 km/h and 200 km/h).

For Active Lane Keeping Assist to assist you when driving, the radar sensor system must be operational.

### Important safety notes

If you fail to adapt your driving style, Active Lane Keeping Assist can neither reduce the risk of accident nor override the laws of physics. Active Lane Keeping Assist cannot take into account road, weather or traffic conditions. Active Lane Keeping Assist is only an aid. You are responsible for the distance to the vehicle in front, for vehicle speed, for braking in good time and for staying in your lane.

Active Lane Keeping Assist cannot continuously keep your vehicle in its lane.

#### **WARNING**

Active Lane Keeping Assist cannot always clearly detect lane markings.

In such cases, Active Lane Keeping Assist can:

- give an unnecessary warning and then make a course-correcting brake application
- neither give a warning nor intervene

There is a risk of an accident.

Always pay particular attention to the traffic situation and keep within the lane, especially if Active Lane Keeping Assist alerts you. Terminate the intervention in a non-critical driving situation.

The system may be impaired or may not function if:

- there is poor visibility, e.g. due to insufficient illumination of the road, or due to snow, rain, fog or heavy spray
- there is glare, e.g. from oncoming traffic, the sun or reflection from other vehicles (e.g. if the road surface is wet)
- the windshield is dirty, fogged up, damaged or covered, for instance by a sticker, in the vicinity of the camera
- there are no lane markings, or several unclear lane markings are present, e.g. around construction sites
- the lane markings are worn away, dark or covered up, e.g. by dirt or snow
- the distance to the vehicle in front is too short and thus the lane markings cannot be detected
- the lane markings change quickly, e.g. lanes branch off, cross one another or merge
- the road is narrow and winding
- there are highly variable shade conditions on the roadway
- no vehicle is detected in the adjacent lane and there are broken lane markings

### Warning vibration in the steering wheel

A warning may be given if a front wheel passes over a lane marking. You will then be warned by means of a vibration through the steering wheel lasting for up to 1.5 seconds.

In order that you are warned only when necessary and in good time if you cross the lane marking, the system detects certain conditions and warns you accordingly.

The warning vibration occurs earlier if:

- you approach the outer lane marking on a bend
- the road has very wide lanes, e.g. a freeway
- the system detects solid lane markings

The warning vibration occurs later if:

- the road has narrow lanes
- you cut the corner on a bend

### Lane-correcting brake application

#### WARNING

A lane-correcting brake application cannot always bring the vehicle back into the original lane. There is a risk of an accident.

Always steer, brake or accelerate yourself, especially if Active Lane Keeping Assist warns you or makes a lane-correcting brake application.

#### WARNING

Active Lane Keeping Assist only detects traffic conditions or road users to a limited extent. In very rare cases, the system may make an inappropriate brake application, e.g. after intentionally driving over a solid lane marking. There is a risk of an accident.

An inappropriate brake application may be interrupted at any time if you steer slightly in the opposite direction. Always make sure that there is sufficient distance on the side for other traffic or obstacles.

In rare cases, Active Lane Keeping Assist could detect broken line markings or special structures on the road surface as solid lane markings. An inappropriate brake application can be interrupted at any time, for example if you steer slightly in the opposite direction.

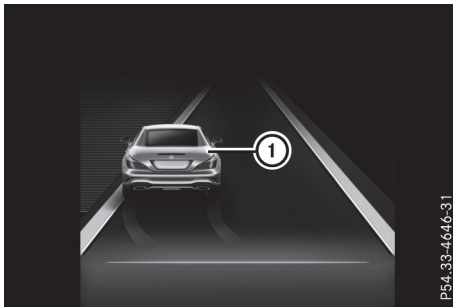

PS4\_33-4646-31

If you leave your lane, under certain circumstances the vehicle will brake briefly on one side. This is meant to assist you in bringing the vehicle back to the original lane.

If a lane-correcting brake application occurs, display ① appears in the multifunction display.

A lane-correcting brake application can be made after driving over a lane marking recognized as being solid or broken. Before this, a warning must have been issued by means of a vibration through the steering wheel. In addition, a lane with lane markings on both sides must have been detected.

In the case of a broken lane marking being detected, a lane-correcting brake application can only be made if a vehicle has been detected in the adjacent lane. The following vehicles can have an influence on brake application: oncoming traffic, vehicles that are overtaking and vehicles that are driving parallel to your vehicle.

**i** A further lane-correcting brake application can only occur after your vehicle has returned to the original lane.

No lane-correcting brake application occurs if:

- you clearly and actively steer, brake or accelerate
- you cut the corner on a sharp bend
- you have switched on the turn signal
- a driving safety system intervenes, e.g. ESP<sup>®</sup>, PRE-SAFE<sup>®</sup> Brake or Active Blind Spot Assist
- you have adopted a sporty driving style with high cornering speeds or high rates of acceleration
- ESP<sup>®</sup> is switched off
- the transmission is not in position **D**

- an obstacle has been detected in the lane in which you are driving
- when a loss of tire pressure or a defective tire has been detected and displayed

There is a possibility that the Active Lane Keeping Assist could misjudge the given traffic situation. An inappropriate brake application may be interrupted at any time if you:

- steer slightly in the opposite direction
- switch on the turn signal
- clearly brake or accelerate

A lane-correcting brake application is interrupted automatically if:

- a driving safety system intervenes, e.g. ESP<sup>®</sup>, PRE-SAFE<sup>®</sup> Brake or Active Blind Spot Assist
- lane markings are no longer detected

### Switching on Active Lane Keeping Assist

► Switch on Active Lane Keeping Assist using the on-board computer; to do so, select **Standard** or **Adaptive** (▷ page 199).

If you drive at speeds above 40 mph (60 km/h) and lane markings are detected, the lines in the assistance graphic display are shown in green (▷ page 198). Active Lane Keeping Assist is ready for use.

When **Standard** is selected,

No warning vibration occurs if:

- you switch on the turn signals. In this event, the warnings are suppressed for a certain period of time.
- a driving safety system intervenes, such as ABS, BAS or ESP<sup>®</sup>.

When **Adaptive** is selected,

No warning vibration occurs if:

- you switch on the turn signals. In this event, the warnings are suppressed for a certain period of time.
- a driving safety system intervenes, e.g. ABS, BAS or ESP<sup>®</sup>.
- you accelerate hard, e.g. kickdown.
- you brake hard.
- you steer actively, e.g. swerve to avoid an obstacle or change lanes quickly.
- you cut the corner on a sharp bend.

## Important safety notes

### WARNING

If you operate information systems and communication equipment integrated in the vehicle when driving, you may be distracted from the traffic situation. You could also lose control of the vehicle. There is a risk of an accident.

Only operate this equipment when the traffic situation permits. If you are not sure that this is possible, park the vehicle paying attention to traffic conditions and operate the equipment when the vehicle is stationary.

You must observe the legal requirements for the country in which you are currently driving when operating the on-board computer.

### WARNING

If the instrument cluster has failed or malfunctioned, you may not recognize function restrictions in systems relevant to safety. The operating safety of your vehicle may be impaired. There is a risk of an accident.

Drive on carefully. Have the vehicle checked at a qualified specialist workshop immediately.

The on-board computer only shows messages or warnings from certain systems in the multifunction display. You should therefore make sure your vehicle is operating safely at all times.

If the operating safety of your vehicle is impaired, pull over as soon as it is safe to do so. Contact a qualified specialist workshop. For an overview, see the instrument panel illustration (▷ page 33).



## Displays and operation

### Instrument cluster lighting

The lighting in the instrument cluster, in the displays and the controls in the vehicle interior can be adjusted using the brightness control knob.

The brightness control knob is located on the bottom left of the instrument cluster (▷ page 33).

- Turn the brightness control knob clockwise or counter-clockwise.

If you turn the light switch (▷ page 109) to the ,  or  position, the brightness will depend upon the brightness of the ambient light.

The light sensor in the instrument cluster automatically controls the brightness of the multifunction display. In daylight, the displays in the instrument cluster are not illuminated.

### Speedometer with segments

The segments in the speedometer indicate which speed range is available.

- Cruise control activated (▷ page 154):  
The segments light up from the stored speed to the maximum speed.
- Active Distance Assist DISTRONIC activated (▷ page 156):  
One or two segments in the set speed range light up.
- Active Distance Assist DISTRONIC detects a vehicle in front moving more slowly than the stored speed:

The segments between the speed of the vehicle in front and the stored speed light up.

### Tachometer

-  Do not drive in the overrevving range, as this could damage the engine.

The red band in the tachometer indicates the engine's overrevving range.

The fuel supply is interrupted to protect the engine when the red band is reached.

### Outside temperature display

You should pay special attention to road conditions when temperatures are around freezing point.

Bear in mind that the outside temperature display indicates the temperature measured and does not record the road temperature.

The outside temperature display is in the multifunction display (▷ page 192).

A change in the outside temperature is shown in the multifunction display after a delay.

### Coolant temperature gage

#### WARNING

Opening the hood when the engine is overheated or when there is a fire in the engine compartment could expose you to hot gases or other service products. There is a risk of injury.

Let an overheated engine cool down before opening the hood. If there is a fire in the engine compartment, keep the hood closed and contact the fire department.

**!** A display message is shown if the coolant temperature is too high.

If the coolant temperature is over 248 °F (120 °C), do not continue driving. The engine will otherwise be damaged.

The coolant temperature gage is in the instrument cluster on the right-hand side (▷ page 33).

The **H** marking in the coolant temperature gauge corresponds to a coolant temperature of approximately 248 °F (120 °C).

Under normal operating conditions and at the correct coolant level, the coolant temperature gauge may rise to the **H** marking.

### Operating the on-board computer

#### Overview

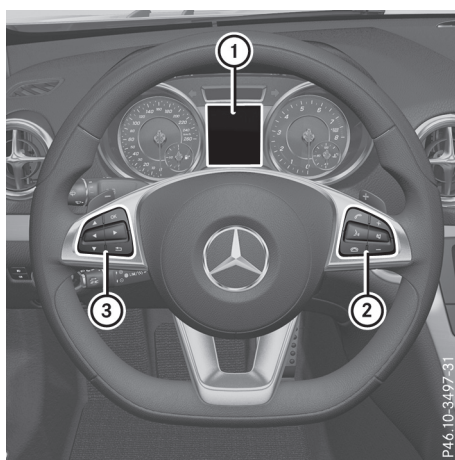

- ① Multifunction display
- ② Right control panel
- ③ Left control panel

► **To activate the on-board computer:** turn the SmartKey to position **1** in the ignition lock.

You can control the multifunction display and the settings in the on-board computer using the buttons on the multifunction steering wheel.

#### Left control panel







- Calls up the menu and menu bar







#### Press briefly:



- Scrolls in lists
- Selects a submenu or function
- In the **Audio** menu: selects the previous or next station, when the preset list or station list is active, or an audio track or video scene
- In the **Tel** (telephone) menu: switches to the phone book and selects a name or telephone number

 	<p><b>Press and hold:</b></p> <ul style="list-style-type: none"> <li>In the <b>Audio</b> menu: selects a pre-set list or a station list in the desired frequency range, selects an audio track or video scene using rapid scrolling</li> <li>In the <b>Tel</b> (Telephone) menu: starts rapid scrolling if the phone book is open</li> </ul>
	<ul style="list-style-type: none"> <li>Confirms the selection or display message</li> <li>In the <b>Tel</b> (Telephone) menu: switches to the telephone book and starts dialing the selected number</li> </ul>
	<p><b>Press briefly:</b></p> <ul style="list-style-type: none"> <li>Back</li> <li>Switches off the Voice Control System</li> <li>Hides display messages or calls up the last <b>Trip</b> menu function used</li> <li>Exits the telephone book/redial memory</li> </ul>
	<p><b>Press and hold:</b></p> <ul style="list-style-type: none"> <li>Calls up the standard display in the <b>Trip</b> menu</li> </ul>

### Right control panel

	<ul style="list-style-type: none"> <li>Rejects or ends a call</li> <li>Exits the telephone book/redial memory</li> </ul>
	<ul style="list-style-type: none"> <li>Makes or accepts a call</li> <li>Switches to the redial memory</li> </ul>
	<ul style="list-style-type: none"> <li>Adjusts the volume</li> </ul>
	<ul style="list-style-type: none"> <li>Mute</li> </ul>
	<ul style="list-style-type: none"> <li>Switches on the Voice Control System</li> </ul>

Further information on the Voice Control System is available in the separate operating instructions.

### Multifunction display

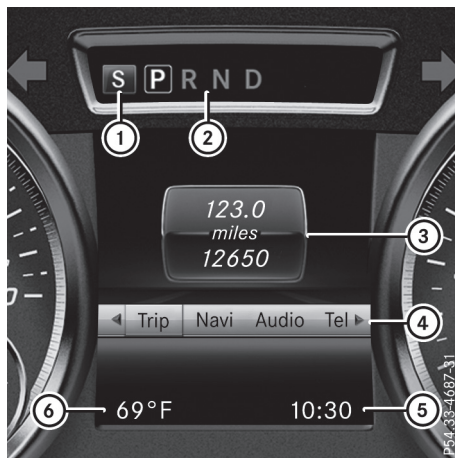



- ① Drive program (▷ page 135)
- ② Transmission position (▷ page 135)
- ③ Text field
- ④ Menu bar
- ⑤ Time
- ⑥ Outside temperature or speed (▷ page 199)

Set the time using the multimedia system; see the Digital Operator's Manual.

- **To display menu bar ④:** press the ◀ or ▶ button on the steering wheel. If you do not press the buttons any longer, menu bar ④ is faded out after a few seconds.

Text field ③ shows the selected menu or submenu and display messages.

### Possible displays in the multifunction display:

- ⬆ Gearshift recommendation, when shifting manually (▷ page 143)
- **P** Active Parking Assist (▷ page 175)
- **CRUISE** Cruise control (▷ page 154)
-  Adaptive Highbeam Assist (▷ page 112)
-  ECO start/stop function (▷ page 129)
- **HOLD** HOLD function (▷ page 165)
-  Active Steering Assist (▷ page 156)



## Menus and submenus

### Menu overview

Using the ◀ or ▶ button on the steering wheel, open the menu bar.

Operating the on-board computer (▷ page 191).

Depending on the vehicle equipment, you can select the following menu:

- **Trip** menu (▷ page 193)
- **Navi** menu (navigation instructions) (▷ page 194)
- **Audio** menu (▷ page 195)
- **Tel** menu (telephone) (▷ page 196)
- **DriveAssist** menu (assistance) (▷ page 197)
- **Serv.** menu (▷ page 199)
- **Sett.** menu (settings) (▷ page 199)
- **AMG** menu (Mercedes-AMG vehicles) (▷ page 202)

### Trip menu

#### Standard display



- ▶ Press and hold the button on the steering wheel until the **Trip** menu with trip odometer ① and odometer ② appears.

#### Trip computer "From Start" or "From Reset"



- ① Distance
- ② Driving time

- ③ Average speed
- ④ Average fuel consumption

- ▶ Press the ◀ or ▶ button on the steering wheel to select the **Trip** menu.
- ▶ Press the ▲ or ▼ button to select **From Start** or **From Reset**.

The values in the **From Start** submenu are calculated from the start of a journey whilst the values in the **From Reset** submenu are calculated from the last time the submenu was reset (▷ page 194).

In the following cases, the trip computer is automatically reset **From Start**:

- the ignition has been switched off for more than four hours.
- 999 hours have been exceeded.
- 9,999 miles have been exceeded.

When 9,999 hours or 99,999 miles have been exceeded, the trip computer is automatically reset **From Reset**.

### ECO display

The ECO display is not available in Mercedes-AMG vehicles.

- ▶ Press the ◀ or ▶ button on the steering wheel to select the **Trip** menu.
- ▶ Press the ▲ or ▼ button to select **ECO DISPLAY**.



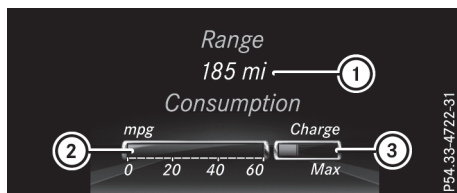

If the ignition remains switched off for longer than four hours, the ECO display will be automatically reset.

For more information on the ECO display, see (▷ page 150).





### Displaying the range and current fuel consumption









Mercedes-AMG vehicles: the menu only displays approximate range ①.

- ▶ Press the  or  button on the steering wheel to select the **Trip** menu.
- ▶ Press  or  to select the display with approximate range ① and current fuel consumption ②.  
Approximate range ① that can be covered is calculated according to your current driving style and the amount of fuel in the tank. If there is only a small amount of fuel left in the fuel tank, a vehicle being refueled  appears instead of approximate range ①.
- Recuperation display ③ shows you if energy has been recuperated from the kinetic energy in overrun mode and saved in the battery. Recuperation display ③ depends on the engine installed and is therefore not available in all vehicles.

### Digital speedometer

- ▶ Press the  or  button on the steering wheel to select the **Trip** menu.
- ▶ Press the  or  button to select the digital speedometer.  
A gearshift recommendation  may also appear in the display.  
Observe the information on gearshift recommendation when shifting manually ( $\triangleright$  page 143).  
Mercedes-AMG vehicles: a gearshift recommendation is shown in the status bar of the multifunction display and not in the digital speedometer display.

### Resetting values

- ▶ Press the  or  button on the steering wheel to select the **Trip** menu.
- ▶ Press the  or  button to select the function that you wish to reset.
- ▶ Press  to confirm your selection.
- ▶ Press  to select **Yes** and press  to confirm.

You can reset the values of the following functions:

- Trip odometer
- "From Start" trip computer
- "From Reset" trip computer
- ECO display

If you reset the values in the ECO display, the values in the "From Start" trip computer are



also reset. If you reset the values in the "From Start" trip computer, the values in the ECO display are also reset.

### Navigation system menu

#### Displaying navigation instructions

In the **Navi** menu, the multifunction display shows navigation instructions.

Observe the additional information on navigation in the Digital Operator's Manual of the multimedia system.

- ▶ Switch on the multimedia system (see the Digital Operator's Manual)
- ▶ Press the  or  button on the steering wheel to select the **Navi** menu.

#### Route guidance not active

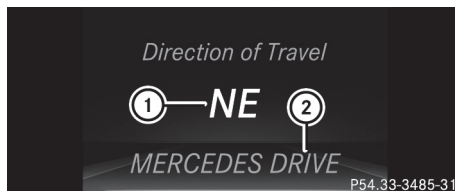

- ① Direction of travel
- ② Current road

#### Route guidance active

#### No change of direction announced

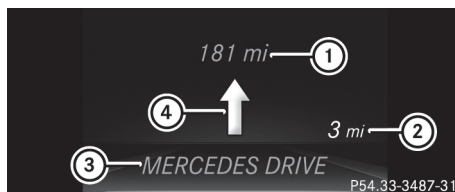

- ① Distance to destination
- ② Distance to the next change of direction
- ③ Current road
- ④ "Follow the road's course" symbol

### Change of direction announced without a lane recommendation

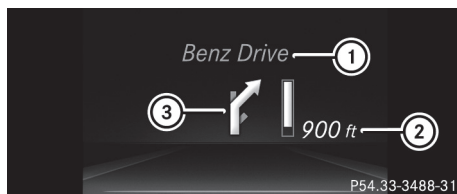

- ① Road into which the change of direction leads
- ② Distance to change of direction and visual distance display
- ③ Change-of-direction symbol

When a change of direction is announced, you will see change-of-direction symbol ③ and distance graphic ②. The distance indicator shortens towards the top of the display as you approach the point of the announced change of direction.

### Change of direction announced with a lane recommendation



- ① Road into which the change of direction leads
- ② Distance to change of direction and visual distance display
- ③ Lanes not recommended
- ④ Recommended lane and new lane during a change of direction
- ⑤ Change-of-direction symbol

On multilane roads, new lane recommendations can be displayed for the next change of direction if the digital map supports this data. During the change of direction, new lanes may be added.

Lane not recommended ③: you will not be able to complete the next change of direction if you stay in this lane.

Recommended lane and new lane during a change of direction ④: in this lane you will be able to complete the next two changes of direction without changing lane.

### Other status indicators of the navigation system



The navigation system displays additional information and the vehicle status.

Possible displays:

- **New Route...** or **Calculating Route...**  
A new route is calculated.
- **Road Not Mapped**  
The vehicle position is inside the area of the digital map but the road is not recognized, e.g. newly built streets, car parks or private land.
- **No Route**  
No route could be calculated to the selected destination.
-   
You have reached the destination or an intermediate destination.



### Audio menu





#### Selecting a radio station



- ① Active station list
- ② Station frequency with memory position

The multifunction display shows station ② with station frequency or station name. The preset position is only displayed along with station ② if this has been stored.

- ▶ Switch on the multimedia system and select radio (see the Digital Operator's Manual).
- ▶ Press the  or  button on the steering wheel to select the **Audio** menu.

- ▶ **To select a preset list or station list:** press and briefly hold the  or  button until the preset list or station list in the desired frequency range is shown.
- ▶ **To select a station:** briefly press  or .







SIRIUS XM® satellite radio acts like a normal radio.



For more information on radio operation, see "Satellite radio" in the Digital Operator's Manual.

### Operating an audio player or media



You can play audio files from various audio players or data media, depending on the equipment installed in the vehicle.







- ▶ Switch on the multimedia system and select CD or MP3 mode (see the Digital Operator's Manual).
- ▶ Press the  or  button on the steering wheel to select the **Audio** menu.
- ▶ **To select the next/previous track:** briefly press the  or  button.
- ▶ **To select a track from the track list (rapid scrolling):** press and hold the  or  button until desired track ① appears.

If you press and hold the  or  button, the rapid scrolling speed is increased. Not all audio players or media support this function.

If track information is saved on the audio player or media, the multifunction display will show the number and title of the track.

### Video DVD operation



- ▶ Switch on the multimedia system and select video DVD (see the Digital Operator's Manual).
- ▶ Press the  or  button on the steering wheel to select the **Audio** menu.
- ▶ **To select the next or previous scene:** briefly press the  or  button.
- ▶ **To select a scene from the scene list (rapid scrolling):** press and hold the  or  button until desired scene ① appears.

### Telephone menu

#### Introduction



#### WARNING

If you operate information systems and communication equipment integrated in the vehicle when driving, you may be distracted from the traffic situation. You could also lose control of the vehicle. There is a risk of an accident.

Only operate this equipment when the traffic situation permits. If you are not sure that this is possible, park the vehicle paying attention to traffic conditions and operate the equipment when the vehicle is stationary.

When telephoning, you must observe the legal requirements for the country in which you are currently driving.

- ▶ Switch on the mobile phone (see the manufacturer's operating instructions).
- ▶ Switch on the multimedia system (see the Digital Operator's Manual)

- ▶ Establish a Bluetooth® connection to the multimedia system (▷ page 246).
- ▶ Press the  or  button on the steering wheel to select the **Te1** menu.

You will see one of the following display messages in the multifunction display:

- **Phone READY** or the name of the network provider: the mobile phone has found a network and is ready to receive.
- **Phone No Service**: there is no network available or the mobile phone is searching for a network.

### Accepting a call

If someone calls you when you are in the **Te1** menu, a display message appears in the multifunction display.







You can accept a call at any time regardless of the menu selected.

- ▶ Press the  button on the steering wheel to accept an incoming call.



### Rejecting or ending a call

- ▶ Press the  button on the steering wheel to reject or end a call.

### Selecting an entry in the phone book



- ▶ Press the  or  button on the steering wheel to select the **Te1** menu.
- ▶ Press the ,  or  button to switch to the phone book.
- ▶ Authorize access to the phone book on the phone.
- ▶ Press  or  to select the names one after the other.

or



- ▶ **To start rapid scrolling**: press and hold the  or  button for longer than one second.

The names in the phone book are displayed quickly one after the other.

Rapid scrolling stops when you release the button or reach the end of the list.

- ▶ **If only one telephone number is stored for a name**: press the  or  button to start dialing.

or

- ▶ **If there is more than one number for a particular name**: press the  or  button to display the numbers.

- ▶ Press the  or  button to select the number you want to dial.

- ▶ Press the  or  button to start dialing.

or

- ▶ **To exit the telephone book**: press the  or  button.

### Redialing

The on-board computer saves the last names or numbers dialed in the redial memory.



- ▶ Press the  or  button on the steering wheel to select the **Te1** menu.

- ▶ Press the  button to switch to the redial memory.

- ▶ Press the  or  button to select the desired name or number.

- ▶ Press the  or  button to start dialing.

or

- ▶ **To exit the redial memory**: press the  or  button.

### Assistance menu

#### Introduction

Depending on your vehicle's equipment, in the **DriveAssist** menu, you have the following options:

- Displaying the assistance graphic (▷ page 198)
- Mercedes-AMG vehicles: setting the vehicle level (▷ page 170)
- Activating/deactivating Active Steering Assist (▷ page 198)
- Activating/deactivating Active Brake Assist (▷ page 198)
- Activating/deactivating Active Brake Assist with cross-traffic function (▷ page 198)
- Activating/deactivating ATTENTION ASSIST (▷ page 198)
- Activating/deactivating Active Blind Spot Assist (▷ page 199)
- Activating/deactivating Active Lane Keeping Assist (▷ page 199)

## Displaying the assistance graphic



- ▶ Press the  or  button on the steering wheel to select the **DriveAssist** menu.
- ▶ Press the  or  button to select **Assist. Graphic**.
- ▶ Press  to confirm your selection. The multifunction display shows the Distance Assist DISTRONIC distance display in the assistance graphic display.

The assistance graphic shows you the status of and/or information from other driving systems or driving safety systems:

- Distance Assist DISTRONIC (▷ page 156)
  - Active Brake Assist with cross-traffic function (▷ page 70)
  - ATTENTION ASSIST (▷ page 183)
  - Active Lane Keeping Assist (▷ page 187)
- ▶ Press  to display the ATTENTION ASSIST assessment.

## Activating or deactivating Active Steering Assist

- ▶ Press the  or  button on the steering wheel to select the **DriveAssist** menu.
- ▶ Press the  or  button to select **Active Steering Assist**.
- ▶ Confirm by pressing  on the steering wheel. The current selection appears.
- ▶ **To activate/deactivate:** press the  button again. When Active Steering Assist is activated, the multifunction display displays the **Active Steering Assist On** message.

Further information on Active Steering Assist (▷ page 197).

## Activating/deactivating Active Brake Assist

You can use this function to activate or deactivate Active Brake Assist.

You can use the function to activate or deactivate Active Brake Assist or, on vehicles with the Driving Assistance Plus package, to activate or deactivate Active Brake Assist with cross-traffic function.

- ▶ Press the  or  button on the steering wheel to select the **DriveAssist** menu.
- ▶ Press the  or  button to select **Brake Assist**.
- ▶ Press  to confirm. The current selection appears.
- ▶ **To activate/deactivate:** press the  button again. When Active Brake Assist or Active Brake Assist with cross-traffic function is deactivated, the  symbol appears in the multifunction display in the assistance graphic display.

Further information on Active Brake Assist (▷ page 63).

Further information about Active Brake Assist with cross-traffic function (▷ page 70).





## Setting ATTENTION ASSIST

- ▶ Press the  or  button on the steering wheel to select the **DriveAssist** menu.
- ▶ Press the  or  button to select **Attention Assist**.
- ▶ Press  to confirm. The current selection appears.
- ▶ Press  to confirm.
- ▶ Press the  or  button to set **Off**, **Standard** or **Sensitive**.
- ▶ Press the  button to save the setting. When ATTENTION ASSIST is deactivated, the  symbol appears in the multifunction display in the assistance graphics display.

Further information on ATTENTION ASSIST (▷ page 183).









## Activating/deactivating Active Blind Spot Assist

- ▶ Press the  or  button on the steering wheel to select the **DriveAssist** menu.
- ▶ Press the  or  button to select **Blind Spot Assist**.
- ▶ Press **OK** to confirm your selection. The current selection appears.
- ▶ **To activate/deactivate:** press the **OK** button again.

Further information on Active Blind Spot Assist (▷ page 184).

## Activating/deactivating Active Lane Keeping Assist

- ▶ Press the  or  button on the steering wheel to select the **DriveAssist** menu.
- ▶ Press the  or  button to select **Lane Keeping Assist**.
- ▶ Press **OK** to confirm your selection. The current selection appears.
- ▶ Press **OK** again.
- ▶ Press  or  to set **Off**, **Standard** or **Adaptive**.
- ▶ Press the **OK** button to save the setting. When Active Lane Keeping Assist is activated, the multifunction display shows the lane markings as bright lines in the assistance graphic.

Further information on Active Lane Keeping Assist (▷ page 187).

## Service menu

Depending on the equipment installed in the vehicle, you have the following options in the **Serv.** menu:

- Calling up display messages (▷ page 205)
- Checking the tire pressure electronically (▷ page 299)
- Calling up the service due date (▷ page 270)

## Settings menu

### Introduction







Depending on the equipment installed in the vehicle, in the **Sett.** menu you have the following options:

- Changing the instrument cluster settings (▷ page 199)
- Changing the light settings (▷ page 200)
- Changing the vehicle settings (▷ page 201)
- Changing the convenience settings (▷ page 201)
- Restoring the factory settings (▷ page 202)

### Instrument cluster

#### Selecting the distance unit

The **Display Unit Speed-/Odometer:** function allows you to choose whether certain displays appear in kilometers or miles in the multifunction display.

- ▶ Press the  or  button on the steering wheel to select the **Sett.** menu.
- ▶ Press the  or  button to select the **Instrument Cluster** submenu.
- ▶ Press **OK** to confirm.
- ▶ Press the  or  button to select the **Display Unit Speed-/Odometer:** function. The current setting **km** or **miles** appears.
- ▶ Press the **OK** button to save the setting.

The selected unit of measurement for distance applies to:

- the digital speedometer in the **Trip** menu
- the odometer and trip odometer
- the trip computer
- the current consumption and the range
- navigation instructions in the **Navi** menu
- cruise control
- DISTRONIC
- ASSYST PLUS

#### Selecting permanent display

The **Permanent Display:** function allows you to choose whether the multifunction display always shows the outside temperature or the speed.

The speed display is inverse to the speedometer.

- ▶ Press the or button on the steering wheel to select the **Sett.** menu.
- ▶ Press the or button to select the **Instrument Cluster** submenu.
- ▶ Press to confirm.
- ▶ Press the or button to select the **Permanent Display:** function. The current setting, **Outside Temperature** or **Speedometer [km/h]** or **Speedometer [mph]**, appears.
- ▶ **To change the setting:** press again.

## Lights

### Setting the daytime running lamps

This function is not available in Canada.

- ▶ Press the or button on the steering wheel to select the **Sett.** menu.
- ▶ Press the or button to select the **Light** submenu.
- ▶ Press to confirm.
- ▶ Press the or button to select the **Daytime Running Lights** function. If the **Daytime Running Lights** function has been switched on, the cone of light and the symbol in the multifunction display are shown in orange.
- ▶ Press the button to save the setting.

Further information on daytime running lamps (▷ page 109).

### Setting the brightness of the ambient lighting

- ▶ Press the or button on the steering wheel to select the **Sett.** menu.
- ▶ Press the or button to select the **Light** submenu.
- ▶ Press to confirm.
- ▶ Press the or button to select the **Amb. Light +/-** function. The current setting appears.
- ▶ Press to confirm.
- ▶ Press the or button to adjust the brightness to any level from **Off** to **Level 5** (bright).
- ▶ Press the or button to save the setting.

### Setting the ambient lighting color

- ▶ Press the or button on the steering wheel to select the **Sett.** menu.
- ▶ Press the or button to select the **Light** submenu.
- ▶ Press to confirm.
- ▶ Press the or button to select the **Amb. Light Col.** function.
- ▶ Press to confirm.
- ▶ Press the or button to set the color to **SOLAR**, **SOLAR Orange** or **SOLAR Red**.
- ▶ Press the or button to save the setting.

### Activating/deactivating surround lighting and exterior lighting delayed switch-off

- ▶ Press the or button on the steering wheel to select the **Sett.** menu.
- ▶ Press the or button to select the **Lights** submenu.
- ▶ Press to confirm.
- ▶ Press or to select the **Surround Lighting** function. If the **Surround Lighting** function is activated, the multifunction display shows the light cone and the area around the vehicle in orange.
- ▶ Press the button to save the setting.

Deactivating exterior lighting delayed switch-off temporarily:

- ▶ Before leaving the vehicle, turn the SmartKey to position **0** in the ignition lock.
- ▶ Turn the SmartKey to position **2** in the ignition lock. Exterior lighting delayed switch-off is deactivated.

Exterior lighting delayed switch-off is reactivated the next time you start the engine.

If you have activated the **Surround Lighting** function and you turn the light switch to **AUTO**, the following functions are activated when it is dark:

- **surround lighting:** the exterior lighting remains lit for 40 seconds after unlocking with the SmartKey. If you start the engine, the surround lighting is switched off and

automatic headlamp mode is activated (▷ page 109).









- **exterior lighting delayed switch-off:** the exterior lighting remains lit for 60 seconds after the engine is switched off. If you close all the doors and the trunk lid, the exterior lighting goes off after 15 seconds.

Depending on your vehicle's equipment, when the surround lighting and delayed switch-off exterior lighting are on, the following light up:

- parking lamps
- low-beam headlamps
- daytime running lamps
- side marker lamps
- surround lighting in the exterior mirrors

### Activating/deactivating the interior lighting delayed switch-off





If you activate the **Interior Lighting Delay** function, the interior lighting remains on for 20 seconds after you remove the Smart-Key from the ignition lock.

- ▶ Press the  or  button on the steering wheel to select the **Sett.** menu.
- ▶ Press the  or  button to select the **Light** submenu.
- ▶ Press  to confirm.
- ▶ Press the  or  button to select the **Interior Lighting Delay** function. When the **Interior Lighting Delay** function is activated, the vehicle interior is displayed in orange in the multifunction display.
- ▶ Press the  button to save the setting.

## Vehicle

### Activating/deactivating the automatic door locking mechanism

If you activate the **Automatic Door Lock** function, the vehicle is centrally locked above a speed of approximately 9 mph (15 km/h).

- ▶ Press the  or  button on the steering wheel to select the **Sett.** menu.
- ▶ Press the  or  button to select the **Vehicle** submenu.
- ▶ Press  to confirm.

- ▶ Press the  or  button to select the **Automatic Door Lock** function.









When the **Automatic Door Lock** function is activated, the multifunction display shows the left-hand vehicle door in orange.

- ▶ Press the  button to save the setting.

For further information on the automatic locking feature, see (▷ page 81).

### Activating/deactivating the acoustic locking verification signal

If you switch on the **Acoustic Lock** function, an acoustic signal sounds when you lock the vehicle.

- ▶ Press the  or  button on the steering wheel to select the **Sett.** menu.
- ▶ Press the  or  button to select the **Vehicle** submenu.
- ▶ Press  to confirm.
- ▶ Press the  or  button to select the **Acoustic Lock** function. If the **Acoustic Lock** function is activated, the  symbol in the multifunction display lights up orange.
- ▶ Press the  button to save the setting.

## Comfort

### Activating/deactivating the EASY-ENTRY/EXIT feature

#### **WARNING**

When the EASY-ENTRY/EXIT feature adjusts the steering wheel, you and other vehicle occupants – particularly children – could become trapped. There is a risk of injury.

While the EASY-ENTRY/EXIT feature is making adjustments, make sure that no one has any body parts in the sweep of the steering wheel.

If somebody becomes trapped:

- press one of the memory function position buttons, or
- move the switch for steering wheel adjustment in the opposite direction to that in which the steering wheel is moving.

The adjustment process is stopped.

- ▶ Press the or button on the steering wheel to select the **Sett.** menu.
- ▶ Press the or button to select the **Convenience** submenu.
- ▶ Press to confirm.
- ▶ Using or , select the **Easy Entry/Exit** function.  
If the **Easy Entry/Exit** function is activated, the multifunction display shows the steering wheel in orange.
- ▶ Press the button to save the setting.

Further information on the EASY-ENTRY/EXIT feature (▶ page 103).

### Switching the seat belt adjustment on/off

- ▶ Press the or button on the steering wheel to select the **Sett.** menu.
- ▶ Press the or button to select the **Convenience** submenu.
- ▶ Press to confirm.
- ▶ Press the or button to select the **Belt Adjustment** function.  
When the **Belt Adjustment** function is activated, the seat belt is displayed in orange in the multifunction display.
- ▶ Press the button to save the setting.

For further information on belt adjustment, see (▶ page 44).

### Switching the fold-in mirrors when locking feature on/off

This function is only available when the vehicle is equipped with the electrical fold-in function.

This function is only available in Canada.

When you activate the **Auto. Mirror Folding** function, the exterior mirrors are folded in when the vehicle is locked.

If you have switched on the **Auto. Mirror Folding** function and you fold in the exterior mirrors using the button on the door (▶ page 105), they will not fold out automatically. The exterior mirrors can then only be folded out using the button on the door.

- ▶ Press the or button on the steering wheel to select the **Sett.** menu.
- ▶ Press the or button to select the **Convenience** submenu.
- ▶ Press to confirm.

- ▶ Press the or button to select the **Auto. Mirror Folding** function.  
If the **Auto. Mirror Folding** function is switched on, the multifunction display shows the exterior mirror in orange.
- ▶ Press the button to save the setting.

### Restoring the factory settings

- ▶ Press the or button on the steering wheel to select the **Sett.** menu.
- ▶ Press the or button to select the **Factory Setting** submenu.
- ▶ Press to confirm.  
The **Reset All Settings?** function appears.
- ▶ Press the or button to select **No** or **Yes**.
- ▶ Press the button to confirm the selection.  
If you have selected **Yes** and confirmed, the multifunction display shows a confirmation message.

For safety reasons, the **Daytime Running Lights** function in the **Lights** submenu is only reset if the vehicle is stationary.

### AMG menu (Mercedes-AMG vehicles)

#### Warm-up

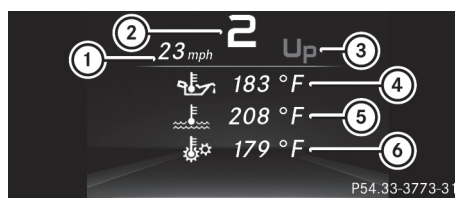

- ① Digital speedometer
  - ② Gear indicator
  - ③ Upshift indicator
  - ④ Engine oil temperature
  - ⑤ Coolant temperature
  - ⑥ Transmission oil temperature
- ▶ Press the or button on the steering wheel to select the **AMG** menu.  
**Upshift indicator:** upshift indicator **UP** ③ indicates that the engine has reached the overrevving range when in the manual drive program.

**Engine and transmission oil tempera-**

**ture:** when the engine and transmission are at normal operating temperature, oil temperature ④ and ⑥ are displayed in white in the multifunction display.

If the multifunction display shows oil temperature ④ or ⑥ in blue, the engine or the transmission are not yet at normal operating temperature. Avoid driving at full engine output during this time.

**SETUP**

- ① Engine mode **C, S, S+** or **M**
- ② Suspension setting **SPORT** or **COMFORT**
- ③ Transmission position **D/M**
- ④ ESP® mode (**On/Off**)

SETUP displays the following information, functions and settings:

- the digital speedometer
- the gear indicator
- the engine mode
- the suspension mode
- the transmission position
- the ESP® (Electronic Stability Program) mode
- ▶ Press **◀** or **▶** on the steering wheel to select the **AMG** menu.
- ▶ Press **▲** repeatedly until **SETUP** appears.

**RACE TIMER****Displaying and starting RACE TIMER**

The RACE TIMER is only intended for use on a closed race circuit. Do not use the function on public roads.

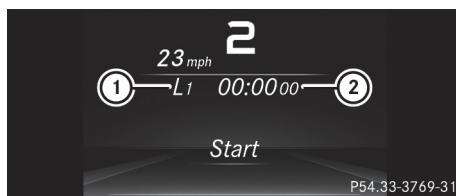

- ① Lap
- ② RACE TIMER

You can start the RACE TIMER when the engine is running or if the SmartKey is in position **2** in the ignition lock.

- ▶ Press the **◀** or **▶** button on the steering wheel to select the **AMG** menu.
- ▶ Press the **▲** button repeatedly until the RACE TIMER appears.
- ▶ **To start:** press the **OK** button to start the RACE TIMER.

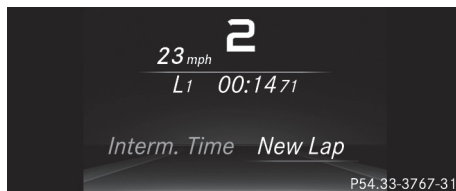
**Displaying the intermediate time**

- ▶ Press the **◀** or **▶** button to select **Interm. Time**.
- ▶ Press **OK** to confirm.  
The intermediate time appears for five seconds.

**Starting a new lap**

- ① RACE TIMER
- ② Fastest lap time (best lap)
- ③ Lap
- ▶ Press **OK** to confirm **New Lap**.

It is possible to store a maximum of sixteen laps. The 16th lap can only be completed with **Finish Lap**.

## Stopping the RACE TIMER



- ▶ Press the button on the steering wheel.
- ▶ Confirm **Yes** with .

The RACE TIMER interrupts timing if you stop the vehicle and turn the SmartKey to position **1** in the ignition lock. If you turn the SmartKey to position **3** and then press to confirm **Start**, timing is continued.

## Resetting the current lap

- ▶ Stop the RACE TIMER.
- ▶ Press the or button to select **Reset Lap**.
- ▶ Press to reset the lap time to "0".

## Deleting all laps



If you switch off the engine, the RACE TIMER is reset to "0" after 30 seconds. All laps are deleted.

You cannot delete individual stored laps. If you have stopped 16 laps, the current lap does not have to be reset.

- ▶ Reset the current lap.
- ▶ Press to confirm **Reset**. **Reset Race-Timer?** appears in the multi-function display.
- ▶ Press the button to select **Yes** and press the button to confirm. All laps are deleted.

## Overall statistics

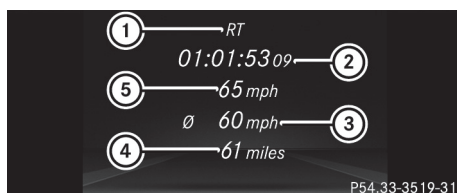

- ① RACETIMER overall evaluation
- ② Total time driven
- ③ Average speed
- ④ Distance covered
- ⑤ Maximum speed

If you save at least one lap and then stop RACETIMER, an overall evaluation is available.

- ▶ Press the or button on the steering wheel to select the **AMG** menu.
- ▶ Press the button repeatedly until the overall evaluation appears.

## Lap statistics

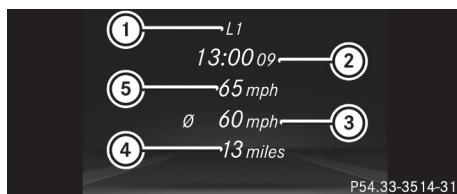

- ① Lap
- ② Lap time
- ③ Average lap speed
- ④ Lap length
- ⑤ Top speed during lap

This function is only available if you have stored at least two laps and have stopped the RACETIMER.

- ▶ Press the or button on the steering wheel to select the **AMG** menu.
- ▶ Press the button repeatedly until the lap evaluation is shown. Each lap is shown in a separate submenu. The fastest lap is indicated by flashing symbol **1**.
- ▶ Press the or button to select a different lap evaluation.



## Display messages

### Introduction

#### General notes

---

Display messages appear in the multifunction display.

Display messages with graphic displays may be shown in simplified form in the Operator's Manual and may therefore differ from the multifunction display.

Please respond in accordance with the display messages and follow the additional notes in this Operator's Manual.

Certain display messages are accompanied by an audible warning tone or a continuous tone.

When you stop and park the vehicle, please observe the notes on:

- HOLD function (▷ page 165)
- Parking (▷ page 146)

#### Hiding display messages

---

- ▶ Press the  or  button on the steering wheel.  
The multifunction display hides the display message.







High-priority display messages are shown in red in the multifunction display. Some high-priority display messages cannot be hidden.

The multifunction display shows these messages continuously until the causes for the messages have been remedied.

#### Message memory

---

The on-board computer saves certain display messages in the **message memory**. You can call up the display messages:

- ▶ Press the  or  button on the steering wheel to select the **Serv.** menu.  
If there are display messages, the multifunction display shows **2 Messages**, for example.
- ▶ Press the  or  button to select the entry, e.g. **2 Messages**.
- ▶ Press  to confirm.
- ▶ Press the  or  button to scroll through the display messages.

When the ignition is switched off, all display messages are deleted, apart from some high-priority display messages. Once the causes of the high-priority display messages have been rectified, the corresponding display messages are also deleted.

## Safety systems

## Display messages



Currently Unavailable See Operator's Manual

## Possible causes/consequences and ► Solutions

ABS (Anti-lock Braking System) and ESP® (Electronic Stability Program) are temporarily not available. Other driving systems and driving safety systems may also malfunction.

In addition, the ,  and  warning lamps light up in the instrument cluster.

Possible causes are:

- Self-diagnosis is not yet complete
- The on-board voltage may be insufficient

 **WARNING**

The brake system continues to function normally, but without the functions listed above. The wheels could therefore lock if you brake hard, for example.

The steerability and braking characteristics may be severely affected. The braking distance in an emergency braking situation can increase.

If ESP® is not operational, ESP® is unable to stabilize the vehicle. There is an increased risk of skidding and an accident.

- Carefully drive a suitable distance, making slight steering movements at a speed above 12 mph (20 km/h).  
If the display message disappears, the functions mentioned above are available again.

If the multifunction display still shows the display message:





- Drive on carefully.
- Visit a qualified specialist workshop immediately.



Inoperative See Operator's Manual

ABS and ESP® are malfunctioning.

Other driving systems and driving safety systems may also malfunction.

The **BRAKE** (USA only) or  (Canada only), ,  and  warning lamps in the instrument cluster also light up.







 **WARNING**



















The brake system continues to function normally, but without the functions listed above. The wheels could therefore lock if you brake hard, for example.









The steerability and braking characteristics may be severely affected. The braking distance in an emergency braking situation can increase.













If ESP® is not operational, ESP® is unable to stabilize the vehicle. There is an increased risk of skidding and an accident.

- Drive on carefully.
- Visit a qualified specialist workshop immediately.











Display messages	Possible causes/consequences and ► Solutions
 <p data-bbox="116 220 347 293">Currently Unavailable See Operator's Manual</p>	<p data-bbox="372 172 1028 309">ESP® is temporarily unavailable. Other driving systems and driving safety systems may also malfunction. In addition, the  and  warning lamps light up in the instrument cluster. The self-diagnosis function might not be complete, for example.</p> <p data-bbox="385 357 535 383"><b>▲ WARNING</b></p> <p data-bbox="372 400 1003 501">The brake system continues to function normally, but without the functions listed above. The braking distance in an emergency braking situation can thus increase.</p> <p data-bbox="372 512 1000 568">If ESP® is not operational, ESP® is unable to stabilize the vehicle. There is an increased risk of skidding and an accident.</p> <p data-bbox="372 579 1012 676">► Carefully drive a suitable distance, making slight steering movements at a speed above 12 mph (20 km/h). If the display message disappears, the functions mentioned above are available again.</p> <p data-bbox="372 692 945 718">If the multifunction display still shows the display message:</p> <ul data-bbox="372 729 869 783" style="list-style-type: none"> <li>► Drive on carefully.</li> <li>► Visit a qualified specialist workshop immediately.</li> </ul>
 <p data-bbox="116 853 320 908">Inoperative See Operator's Manual</p>	<p data-bbox="372 805 1028 943">ESP® is malfunctioning. Other driving systems and driving safety systems may also malfunction. In addition, the  and  warning lamps light up in the instrument cluster.</p> <p data-bbox="385 959 535 984"><b>▲ WARNING</b></p> <p data-bbox="372 1002 1003 1102">The brake system continues to function normally, but without the functions listed above. The braking distance in an emergency braking situation can thus increase.</p> <p data-bbox="372 1114 1000 1169">If ESP® is not operational, ESP® is unable to stabilize the vehicle. There is an increased risk of skidding and an accident.</p> <ul data-bbox="372 1181 869 1235" style="list-style-type: none"> <li>► Drive on carefully.</li> <li>► Visit a qualified specialist workshop immediately.</li> </ul>

Display messages	Possible causes/consequences and ► Solutions
   <p>Inoperative See Operator's Manual</p>	<p>EBD (electronic brake force distribution), ABS and ESP<sup>®</sup> are malfunctioning.</p> <p>Other driving systems and driving safety systems may also malfunction.</p> <p>In addition, the ,  and  warning lamps light up in the instrument cluster and a warning tone sounds.</p> <p><b>▲ WARNING</b></p> <p>The brake system continues to function normally, but without the functions listed above. The front and rear wheels could therefore lock if you perform a full brake application, for example.</p> <p>The steerability and braking characteristics may be severely affected. The braking distance in an emergency braking situation can increase.</p> <p>If ESP<sup>®</sup> is not operational, ESP<sup>®</sup> is unable to stabilize the vehicle. There is an increased risk of skidding and an accident.</p> <ul style="list-style-type: none"> <li>► Drive on carefully.</li> <li>► Visit a qualified specialist workshop immediately.</li> </ul>
<p> (USA only)  (Canada only)</p> <p>Turn On the Ignition to Release the Parking Brake</p>	<p>The red  (USA only) or  (Canada only) indicator lamp lights up.</p> <p>You attempted to release the electric parking brake while the ignition was switched off.</p> <ul style="list-style-type: none"> <li>► <b>SmartKey:</b> turn the SmartKey to position <b>1</b> in the ignition lock.</li> <li>► <b>KEYLESS-GO:</b> switch on the ignition.</li> </ul>
<p> (USA only)  (Canada only)</p> <p>Please Release Parking Brake</p>	<p>The red  (USA only) or  (Canada only) indicator lamp flashes and a warning tone sounds. A condition for automatic release of the electric parking brake is not fulfilled (▷ page 147).</p> <p>You are driving with the electric parking brake applied.</p> <ul style="list-style-type: none"> <li>► Release the electric parking brake manually.</li> </ul> <p>The red  (USA only) or  (Canada only) indicator lamp flashes and a warning tone sounds.</p> <p>You are using the electric parking brake for emergency braking (▷ page 147).</p>
<p> (USA only)  (Canada only)</p> <p>Parking Brake See Operator's Manual</p>	<p>The yellow  warning lamp lights up.</p> <p>The electric parking brake is malfunctioning.</p> <p><b>To apply:</b></p> <ul style="list-style-type: none"> <li>► Switch the ignition off.</li> <li>► Press the electric parking brake handle for at least ten seconds.</li> <li>► Shift the transmission to position <b>P</b>.</li> <li>► Consult a qualified specialist workshop.</li> </ul>



Display messages	Possible causes/consequences and ► Solutions
	<p>The yellow  warning lamp and the red  (USA only) or  (Canada only) indicator lamp light up. The electric parking brake is malfunctioning.</p> <p><b>To release:</b></p> <ul style="list-style-type: none"> <li>► Switch off the ignition and turn it back on.</li> <li>► Release the electric parking brake manually.</li> </ul> <p>or</p> <ul style="list-style-type: none"> <li>► Release the electric parking brake automatically (▷ page 147).</li> </ul> <p>If the electric parking brake still cannot be released:</p> <ul style="list-style-type: none"> <li>► Do not drive on.</li> <li>► Consult a qualified specialist workshop.</li> </ul>
	<p>The red  (USA only) or  (Canada only) indicator lamp flashes and the yellow  warning lamp lights up. The electric parking brake is malfunctioning.</p> <p><b>To release:</b></p> <ul style="list-style-type: none"> <li>► Switch off the ignition and turn it back on.</li> <li>► Release the electric parking brake manually.</li> </ul> <p><b>To apply:</b></p> <ul style="list-style-type: none"> <li>► Switch off the ignition and turn it back on.</li> <li>► Apply the electric parking brake manually.</li> </ul> <p>If the red  (USA only) or  (Canada only) indicator lamp continues to flash:</p> <ul style="list-style-type: none"> <li>► Do not drive on.</li> <li>► Secure the vehicle against rolling away (▷ page 314).</li> <li>► Shift the transmission to position .</li> <li>► Turn the front wheels towards the curb.</li> <li>► Consult a qualified specialist workshop.</li> </ul>









Display messages	Possible causes/consequences and ► Solutions
	<p>The yellow  warning lamp lights up. The red  (USA only) or  (Canada only) indicator lamp flashes for about ten seconds after the electric parking brake has been applied or released. It then goes out or remains lit.</p> <p>The electric parking brake is malfunctioning.</p> <ul style="list-style-type: none"> <li>► Switch off the ignition and turn it back on.</li> <li>► Apply the electric parking brake.</li> </ul> <p>If it is not possible to apply the electric parking brake:</p> <ul style="list-style-type: none"> <li>► Shift the transmission to position .</li> <li>► Visit a qualified specialist workshop.</li> </ul> <p>If it is not possible to release the electric parking brake:</p> <ul style="list-style-type: none"> <li>► Release the electric parking brake automatically (&gt; page 147).</li> </ul> <p>If the electric parking brake still cannot be released:</p> <ul style="list-style-type: none"> <li>► Consult a qualified specialist workshop.</li> </ul> <p>The yellow  warning lamp lights up. If you manually apply or release the electric parking brake, the red  (USA only) or  (Canada only) indicator lamp flashes.</p> <p>The electric parking brake is malfunctioning. It is not possible to apply the electric parking brake manually.</p> <ul style="list-style-type: none"> <li>► Shift the transmission to position , as the electric parking brake is not applied automatically.</li> <li>► Visit a qualified specialist workshop.</li> </ul>
<p> (USA only)  (Canada only)</p> <p>Parking Brake Inoperative</p>	<p>The yellow  warning lamp lights up. The red  (USA only) or  (Canada only) indicator lamp flashes for about ten seconds after the electric parking brake has been applied or released. It then goes out or remains lit.</p> <p>The electric parking brake is malfunctioning, e.g. because of overvoltage or undervoltage.</p> <ul style="list-style-type: none"> <li>► Remove the cause for the overvoltage or undervoltage, e.g. by charging the battery or restarting the engine.</li> <li>► Apply or release the electric parking brake.</li> </ul> <p>If it remains impossible to apply or release the electric parking brake:</p> <ul style="list-style-type: none"> <li>► Switch off the ignition and turn it back on.</li> <li>► Apply or release the electric parking brake.</li> </ul> <p>If the electric parking brake still cannot be released:</p> <ul style="list-style-type: none"> <li>► Consult a qualified specialist workshop.</li> </ul> <p>If the electric parking brake still cannot be applied:</p> <ul style="list-style-type: none"> <li>► Visit a qualified specialist workshop.</li> </ul>





Display messages	Possible causes/consequences and ► Solutions
	<p>The yellow  warning lamp lights up and the red  (USA only) or  (Canada only) indicator lamp flashes. It is not possible to apply the electric parking brake manually.</p> <ul style="list-style-type: none"> <li>► Shift the transmission to position .</li> <li>► Visit a qualified specialist workshop.</li> </ul>
<p> (USA only)   (Canada only)  <a href="#">Check Brake Fluid Level</a></p>	<p>There is not enough brake fluid in the brake fluid reservoir. In addition, the  (USA only) or  (Canada only) warning lamp lights up in the instrument cluster and a warning tone sounds.</p> <p> <b>WARNING</b></p> <p>The braking effect may be impaired. There is a risk of an accident.</p> <ul style="list-style-type: none"> <li>► Pull over and stop the vehicle safely as soon as possible, paying attention to road and traffic conditions. Do not continue driving under any circumstances.</li> <li>► Secure the vehicle against rolling away (▷ page 146).</li> <li>► Consult a qualified specialist workshop.</li> <li>► Do not add brake fluid. This does not correct the malfunction.</li> </ul>
<p>  <a href="#">Check Brake Pad Wear</a></p>	<p>The brake pads/linings have reached their wear limit.</p> <ul style="list-style-type: none"> <li>► Visit a qualified specialist workshop.</li> </ul>
<p><a href="#">PRE-SAFE Inoperative See Operator's Manual</a></p>	<p>Important functions of PRE-SAFE® have failed. All other occupant safety systems, e.g. air bags, remain available.</p> <ul style="list-style-type: none"> <li>► Visit a qualified specialist workshop immediately.</li> </ul>
<p><a href="#">Active Brake Assist Functions Currently Limited See Operator's Manual</a></p>	<p>Active Brake Assist is temporarily inoperative. Possible causes are:</p> <ul style="list-style-type: none"> <li>• the radar sensor system is temporarily inoperative, e.g. due to electromagnetic radiation emitted by nearby TV or radio stations or other sources of electromagnetic radiation</li> <li>• the system is outside the operating temperature range</li> <li>• the on-board voltage is too low</li> </ul> <p>When the causes stated above no longer apply, the display message disappears. Active Brake Assist is operational again.</p> <p>If the display message does not disappear:</p> <ul style="list-style-type: none"> <li>► Pull over and stop the vehicle safely as soon as possible, paying attention to road and traffic conditions.</li> <li>► Secure the vehicle against rolling away (▷ page 146).</li> <li>► Restart the engine.</li> </ul>

Display messages	Possible causes/consequences and ► Solutions
Active Brake Assist Functions Limited See Operator's Manual	Active Brake Assist is unavailable due to a malfunction. ► Visit a qualified specialist workshop.
Active Brake Assist Functions Currently Limited See Operator's Manual	Active Brake Assist with cross-traffic function or PRE-SAFE® PLUS is deactivated and temporarily inoperative. Possible causes are: <ul style="list-style-type: none"> <li>• the system is outside the operating temperature range</li> <li>• the on-board voltage is too low</li> <li>• the radar sensor system is temporarily inoperative, e.g. due to electromagnetic radiation emitted by nearby TV or radio stations or other sources of electromagnetic radiation</li> <li>• Mercedes-AMG vehicles: ESP® is deactivated</li> </ul> When the causes stated above no longer apply, the display message disappears. Active Brake Assist with cross-traffic function and PRE-SAFE® PLUS are functional again. ► Pull over and stop the vehicle safely as soon as possible, paying attention to road and traffic conditions. ► Secure the vehicle against rolling away (▷ page 146). ► Restart the engine. ► Mercedes-AMG vehicles: switch ESP® on again (▷ page 68).
Active Brake Assist Functions Limited See Operator's Manual	Active Brake Assist with cross-traffic function or PRE-SAFE® PLUS is not available due to a malfunction. ► Visit a qualified specialist workshop.

Display messages	Possible causes/consequences and ► Solutions
<p>Radar Sensors Dirty See Operator's Manual</p>	<p>The radar sensor system is malfunctioning.</p> <p>Possible causes are:</p> <ul style="list-style-type: none"> <li>• dirt on sensors</li> <li>• heavy rain or snow</li> <li>• when driving on inter-urban roads without traffic or infrastructure, e.g. in desert-like areas</li> </ul> <p>At least one driving system or driving safety system is malfunctioning or is temporarily unavailable:</p> <ul style="list-style-type: none"> <li>• Active Brake Assist</li> <li>• Active Brake Assist with cross-traffic function</li> <li>• Active Distance Assist DISTRONIC</li> <li>• Active Steering Assist</li> <li>• Active Lane Keeping Assist</li> <li>• Active Blind Spot Assist</li> <li>• PRE-SAFE® PLUS</li> </ul> <p>If the radar sensor system in front is dirty, Active Blind Spot Assist will not perform a course-correcting brake application.</p> <p>Once the cause of the problem is no longer present, the driving and drive safety systems will be available again. The display message disappears.</p> <p>If the display message does not disappear:</p> <ul style="list-style-type: none"> <li>► Pull over and stop the vehicle safely as soon as possible, paying attention to road and traffic conditions.</li> <li>► Secure the vehicle against rolling away (▷ page 146).</li> <li>► Switch off the engine.</li> <li>► Clean all sensors (▷ page 275).</li> <li>► Restart the engine.</li> </ul> <p>The display message disappears.</p>
<p> Malfunction Service Required</p>	<p>The roll bars are faulty.</p> <p> <b>WARNING</b></p> <p>The roll bars will then possibly not be extended in the event of an accident.</p> <p>There is an increased risk of injury.</p> <ul style="list-style-type: none"> <li>► Visit a qualified specialist workshop immediately.</li> </ul>

Display messages	Possible causes/consequences and ► Solutions
 <p>SRS Malfunction Service Required</p>	<p>The restraint system is malfunctioning. The  warning lamp also lights up in the instrument cluster.</p> <p> <b>WARNING</b></p> <p>The air bags or Emergency Tensioning Devices may either be triggered unintentionally or, in the event of an accident, may not be triggered.</p> <p>There is an increased risk of injury.</p> <p>► Visit a qualified specialist workshop immediately.</p> <p>Further information about the restraint system (► page 41).</p>
 <p>Front Left Malfunction Service Required or Front Right Malfunction Service Required</p>	<p>The restraint system has malfunctioned at the front on the left or right. The  warning lamp also lights up in the instrument cluster.</p> <p> <b>WARNING</b></p> <p>The air bags or Emergency Tensioning Devices may either be triggered unintentionally or, in the event of an accident, may not be triggered.</p> <p>There is an increased risk of injury.</p> <p>► Visit a qualified specialist workshop immediately.</p>
 <p>Left Side Curtain Air Bag Malfunction Service Required or Right Side Curtain Air Bag Malfunction Service Required</p>	<p>There is a malfunction in the left-hand and/or right-hand head bag. The  warning lamp also lights up in the instrument cluster.</p> <p> <b>WARNING</b></p> <p>The left or right head bag may either be triggered unintentionally or, in the event of an accident, may not be triggered.</p> <p>There is an increased risk of injury.</p> <p>► Visit a qualified specialist workshop immediately.</p>





Display messages	Possible causes/consequences and ► Solutions
<p>Front-passenger Air Bag Disabled See Operator's Manual</p>	<p>The front-passenger front air bag and front-passenger knee air bag are disabled during the journey, although:</p> <ul style="list-style-type: none"> <li>• an adult or</li> <li>• a person of the corresponding stature is on the front-passenger seat</li> </ul> <p>If additional forces are applied to the seat, the system may interpret the occupant's weight as lower than it actually is.</p> <p> <b>WARNING</b></p> <p>The front-passenger front air bag and front-passenger knee air bag may not be triggered in the event of an accident. There is an increased risk of injury.</p> <ul style="list-style-type: none"> <li>► Pull over and stop the vehicle safely as soon as possible, paying attention to road and traffic conditions.</li> <li>► Secure the vehicle against rolling away (▷ page 146).</li> <li>► Switch the ignition off.</li> <li>► Have the occupant on the front-passenger seat get out of the vehicle.</li> <li>► Keep the seat unoccupied, close the front-passenger door and switch on the ignition.</li> <li>► Observe the PASSENGER AIR BAG indicator lamps in the center console and the multifunction display and check the following: Seat unoccupied and ignition switched on: <ul style="list-style-type: none"> <li>• a self-diagnosis is carried out. The PASSENGER AIR BAG OFF and PASSENGER AIR BAG ON indicator lamps must light up simultaneously for approximately six seconds.</li> <li>• the PASSENGER AIR BAG OFF indicator lamp must then light up and remain lit after the self-diagnosis. If the indicator lamp is on, OCS has disabled the front-passenger front air bag and front-passenger knee bag (▷ page 48)</li> <li>• the <a href="#">Front-passenger Air Bag Enabled See Operator's Manual</a> or <a href="#">Front-passenger Air Bag Disabled See Operator's Manual</a> display messages must not appear in the multifunction display</li> </ul> </li> <li>► Wait for a period of at least 60 seconds until the necessary system checks have been completed.</li> <li>► Make sure that the display messages do not appear in the multifunction display.</li> </ul> <p>If these conditions are fulfilled, the front-passenger seat can be occupied again. Whether the PASSENGER AIR BAG OFF or ON indicator lamp remains lit or goes out depends on how OCS classifies the occupant.</p> <p>If the conditions are not fulfilled, the system is not operating correctly.</p> <ul style="list-style-type: none"> <li>► Visit a qualified specialist workshop immediately.</li> </ul> <p>Observe the additional information on OCS (▷ page 48).</p>

Display messages	Possible causes/consequences and ► Solutions
<p data-bbox="85 169 316 272">Front-passenger Air Bag Enabled See Operator's Manual</p>	<p data-bbox="342 169 986 225">The front-passenger front air bag and front-passenger knee air bag are enabled during the journey, although:</p> <ul data-bbox="348 233 1000 344" style="list-style-type: none"> <li data-bbox="348 233 1000 288">• a child, a small adult or an object weighing less than the system's weight threshold is located on the front-passenger seat or</li> <li data-bbox="348 312 740 344">• the front-passenger seat is unoccupied</li> </ul> <p data-bbox="342 352 994 400">The system may detect objects or forces applying additional weight on the seat.</p> <p data-bbox="353 416 505 440"> <b>WARNING</b></p> <p data-bbox="342 456 994 504">The front-passenger front air bag and the front-passenger knee bag may be deployed unintentionally.</p> <p data-bbox="342 512 678 536">There is an increased risk of injury.</p> <ul data-bbox="342 544 994 1430" style="list-style-type: none"> <li data-bbox="342 544 994 592">► Pull over and stop the vehicle safely as soon as possible, paying attention to road and traffic conditions.</li> <li data-bbox="342 600 880 624">► Secure the vehicle against rolling away (► page 146).</li> <li data-bbox="342 632 583 655">► Switch the ignition off.</li> <li data-bbox="342 663 667 687">► Open the front-passenger door.</li> <li data-bbox="342 695 972 743">► Remove the child and the child restraint system from the front-passenger seat.</li> <li data-bbox="342 751 958 799">► Make sure that there are no objects on the seat adding to the weight. The system might otherwise detect the additional weight and interpret the seat occupant's weight as greater than it actually is.</li> <li data-bbox="342 807 964 903">► Keep the seat unoccupied, close the front-passenger door and switch on the ignition.</li> <li data-bbox="342 911 994 1318">► Observe the PASSENGER AIR BAG indicator lamps in the center console and the multifunction display and check the following: Seat unoccupied and ignition switched on: <ul data-bbox="370 1007 994 1318" style="list-style-type: none"> <li data-bbox="370 1007 994 1078">• a self-diagnosis is carried out. The PASSENGER AIR BAG OFF and PASSENGER AIR BAG ON indicator lamps must light up simultaneously for approximately six seconds.</li> <li data-bbox="370 1086 994 1214">• the PASSENGER AIR BAG OFF indicator lamp must then light up and remain lit after the self-diagnosis. If the indicator lamp is on, OCS (Occupant Classification System) has disabled the front-passenger front air bag and front-passenger knee air bag (► page 48)</li> <li data-bbox="370 1222 994 1318">• the <a href="#">Front-passenger Air Bag Enabled See Operator's Manual</a> or <a href="#">Front-passenger Air Bag Disabled See Operator's Manual</a> display messages must not appear in the multifunction display</li> </ul> </li> <li data-bbox="342 1326 981 1374">► Wait for a period of at least 60 seconds until the necessary system checks have been completed.</li> <li data-bbox="342 1382 986 1430">► Make sure that the display messages do not appear in the multifunction display.</li> </ul> <p data-bbox="342 1445 986 1493">If these conditions are fulfilled, the front-passenger seat can be occupied again. Whether the PASSENGER AIR BAG OFF or ON indi-</p>





Display messages	Possible causes/consequences and ► Solutions
	<p>ator lamp remains lit or goes out depends on how OCS classifies the occupant.</p> <p>If the conditions are not fulfilled, the system is not operating correctly.</p> <p>► Visit a qualified specialist workshop immediately.</p> <p>Observe the additional information on OCS (► page 48).</p>



## Lights





Display messages	Possible causes/consequences and ► Solutions
 <p>Check Left Low Beam (Example)</p>	<p>The corresponding bulb is faulty.</p> <p>► Visit a qualified specialist workshop.</p> <p>or</p> <p>► Check whether you are permitted to replace the bulb yourself (► page 113).</p> <p>LED light sources: the display message for the corresponding lamp only appears when all the LEDs in the lamp have failed.</p>
 <p>Active Headlamps Inoperative</p>	<p>The active light function is faulty.</p> <p>► Visit a qualified specialist workshop.</p>
 <p>Malfunction See Operator's Manual</p>	<p>The exterior lighting is malfunctioning.</p> <p>► Visit a qualified specialist workshop.</p>
 <p>Auto Lamp Function Inoperative</p>	<p>The light sensor is defective.</p> <p>► Visit a qualified specialist workshop.</p>
 <p>Switch Off Lights</p>	<p>The lights are still switched on when you leave the vehicle. A warning tone also sounds.</p> <p>► Turn the light switch to position <b>AUTO</b>.</p>



Display messages	Possible causes/consequences and ► Solutions
Adaptive Highbeam Assist Currently Unavailable See Operator's Manual	<p>Adaptive Highbeam Assist is deactivated and temporarily inoperative.</p> <p>Possible causes are:</p> <ul style="list-style-type: none"> <li>• The windshield in the camera's field of vision is dirty.</li> <li>• Visibility is impaired due to heavy rain, snow or fog.</li> </ul> <p>► Clean the windshield.</p> <p>If the system detects that the camera is fully operational again, the <b>Adaptive Highbeam Assist Now Available</b> message is displayed.</p> <p>Adaptive Highbeam Assist is operational again.</p>
Adaptive Highbeam Assist Inoperative	<p>Adaptive Highbeam Assist is faulty.</p> <p>► Visit a qualified specialist workshop.</p>

## Engine



Display messages	Possible causes/consequences and ► Solutions
 <p>Check Coolant Level See Operator's Manual</p>	<p>The coolant level is too low.</p> <p><b>!</b> Avoid longer journeys when there is insufficient coolant in the engine cooling system. You could otherwise damage the engine.</p> <ul style="list-style-type: none"> <li>► Add coolant, observing the warning notes before doing so (► page 267).</li> <li>► If you need to add coolant more often than usual, have the engine coolant system checked at a qualified specialist workshop.</li> </ul>
	<p>The fan motor is defective.</p> <ul style="list-style-type: none"> <li>► If the coolant temperature gage is below the <b>H</b> marking (► page 191), drive on to the next qualified specialist workshop.</li> <li>► Avoid heavy loads on the engine as you do so, e.g. driving in mountainous terrain and stop-and-go traffic.</li> </ul>





Display messages	Possible causes/consequences and ► Solutions
 <p data-bbox="116 220 322 296">Coolant Too Hot Stop Vehicle Turn Engine Off</p>	<p data-bbox="372 172 645 225">The coolant is too hot. A warning tone also sounds.</p> <p data-bbox="384 240 535 268"> <b>WARNING</b></p> <p data-bbox="372 284 1025 357">Do not drive when your engine is overheated. This can cause some fluids which may have leaked into the engine compartment to catch fire.</p> <p data-bbox="372 368 992 416">Steam from the overheated engine can also cause serious burns which can occur just by opening the hood.</p> <p data-bbox="372 424 598 448">There is a risk of injury.</p> <ul style="list-style-type: none"> <li data-bbox="372 456 997 504">► Pull over and stop the vehicle safely and switch off the engine, paying attention to road and traffic conditions.</li> <li data-bbox="372 512 908 536">► Secure the vehicle against rolling away (► page 146).</li> <li data-bbox="372 544 1020 592">► Leave the vehicle and keep a safe distance from the vehicle until the engine has cooled down.</li> <li data-bbox="372 600 953 647">► Make sure that the air supply to the engine radiator is not blocked, e.g. by snow, slush or ice.</li> <li data-bbox="372 655 1014 735">► Do not start the engine again until the display message goes out and the coolant temperature gage is below the <b>H</b> marking (► page 191). Otherwise, the engine could be damaged.</li> <li data-bbox="372 743 981 791">► Pay attention to the coolant temperature gage, observing the warning notes (► page 267).</li> <li data-bbox="372 799 981 847">► If the temperature increases again, visit a qualified specialist workshop immediately.</li> </ul> <p data-bbox="372 855 1020 935">Under normal operating conditions and at the correct coolant level, the coolant temperature gage may rise to the <b>H</b> marking (► page 191).</p>
 <p data-bbox="116 997 344 1045">See Operator's Manual</p>	<p data-bbox="372 949 689 973">The battery is not being charged.</p> <p data-bbox="372 981 645 1005">A warning tone also sounds.</p> <p data-bbox="372 1013 568 1037">Possible causes are:</p> <ul style="list-style-type: none"> <li data-bbox="372 1045 602 1069">• a defective alternator</li> <li data-bbox="372 1077 563 1101">• a torn poly-V-belt</li> <li data-bbox="372 1109 701 1133">• a malfunction in the electronics</li> </ul> <p data-bbox="372 1141 997 1173"><b>!</b> Do not drive any further. Otherwise the engine may overheat.</p> <ul style="list-style-type: none"> <li data-bbox="372 1181 997 1228">► Pull over and stop the vehicle safely and switch off the engine, paying attention to road and traffic conditions.</li> <li data-bbox="372 1236 908 1260">► Secure the vehicle against rolling away (► page 146).</li> <li data-bbox="372 1268 779 1300">► Consult a qualified specialist workshop.</li> </ul>

Display messages	Possible causes/consequences and ► Solutions
 <p>Stop Vehicle See Operator's Manual</p>	<p>The battery is no longer being charged and the condition of charge is too low. A warning tone also sounds.</p> <ul style="list-style-type: none"> <li>► Pull over and stop the vehicle safely and switch off the engine, paying attention to road and traffic conditions.</li> <li>► Secure the vehicle against rolling away (▷ page 146).</li> <li>► Observe the instructions in the  See Operator's Manual display message.</li> <li>► Consult a qualified specialist workshop.</li> </ul>
 <p>Check Engine Oil At Next Refueling</p>	<p>The engine oil level has dropped to the minimum level. A warning tone also sounds.</p> <ul style="list-style-type: none"> <li>! Avoid longer journeys when there is insufficient engine oil. You could otherwise damage the engine.</li> <li>► Check the oil level when next refueling, at the latest (▷ page 266).</li> <li>► If necessary, add engine oil (▷ page 266).</li> <li>► Have the engine checked at a qualified specialist workshop if you need to add engine oil more often than usual.</li> </ul> <p>Information on approved engine oils can be obtained from a qualified specialist workshop or on the Internet at <a href="http://bevo.mercedes-benz.com">http://bevo.mercedes-benz.com</a>.</p>
 <p>Check Engine Oil Level (Add 1 quart)</p>	<p>Mercedes-AMG vehicles: The engine oil level is too low.</p> <ul style="list-style-type: none"> <li>! Avoid longer journeys when there is insufficient engine oil. You could otherwise damage the engine.</li> <li>► Check the oil level when next refueling, at the latest (▷ page 266).</li> <li>► If necessary, add engine oil (▷ page 266).</li> <li>► Have the engine checked at a qualified specialist workshop if you need to add engine oil more often than usual.</li> </ul> <p>Information on approved engine oils can be obtained from a qualified specialist workshop or on the Internet at <a href="http://bevo.mercedes-benz.com">http://bevo.mercedes-benz.com</a>.</p>
 <p>Engine Oil Level Low Stop Vehicle Turn Engine Off</p>	<p>Mercedes-AMG vehicles: The engine oil level is too low. There is a risk of engine damage.</p> <ul style="list-style-type: none"> <li>► Pull over and stop the vehicle safely and switch off the engine, paying attention to road and traffic conditions.</li> <li>► Secure the vehicle against rolling away (▷ page 146).</li> <li>► Check the engine oil level (▷ page 266).</li> <li>► If necessary, add engine oil (▷ page 266).</li> </ul>



Display messages	Possible causes/consequences and ► Solutions
 Fuel Level Low	The fuel level has dropped into the reserve range. ► Refuel at the nearest gas station.
 Gas Cap Loose	There is only a very small amount of fuel in the fuel tank. ► Refuel at the nearest gas station without fail.
 Gas Cap Loose	The fuel filler cap is not closed correctly or the fuel system is leaking. ► Check that the fuel filler cap is correctly closed. <b>If the fuel filler cap is not correctly closed:</b> ► Close the fuel filler cap. <b>If the fuel filler cap is correctly closed:</b> ► Visit a qualified specialist workshop.

## Driving systems

Display messages	Possible causes/consequences and ► Solutions
ABC Malfunction	The Active Body Control (ABC) function is restricted.  <b>WARNING</b> The vehicle's suspension settings may be affected. There is a risk of an accident. ► Do not drive at speeds above 50 mph (80 km/h). ► Visit a qualified specialist workshop immediately.
ABC Malfunction Stop Vehicle	The Active Body Control (ABC) vehicle level is too low. ► Pull over and stop the vehicle safely as soon as possible, paying attention to road and traffic conditions. After a few seconds, the vehicle level is adjusted and the display message disappears.
	The vehicle is leaking oil. The multifunction display continuously shows the display message.  <b>WARNING</b> The vehicle's suspension settings may be affected. There is a risk of an accident. ► Pull over and stop the vehicle safely as soon as possible, paying attention to road and traffic conditions. Do not continue driving under any circumstances. ► Secure the vehicle against rolling away (► page 146). ► Consult a qualified specialist workshop or breakdown service immediately.

Display messages	Possible causes/consequences and ► Solutions
	<p>Active Body Control (ABC) is malfunctioning. The multifunction display continuously shows the display message.</p> <p> <b>WARNING</b></p> <p>The suspension settings are thus affected. There is a risk of an accident.</p> <ul style="list-style-type: none"> <li>► Do not drive at speeds above 50 mph (80 km/h).</li> <li>► Make only slight steering movements. Otherwise, the front fender or the tires could be damaged if the steering movement is too large.</li> <li>► Listen for scraping sounds.</li> <li>► Visit a qualified specialist workshop immediately.</li> </ul>
<p> Attention Assist: Take a Break!</p>	<p>Based on certain criteria, ATTENTION ASSIST has detected fatigue or a lack of concentration on the part of the driver. A warning tone also sounds.</p> <ul style="list-style-type: none"> <li>► If necessary, take a break.</li> </ul> <p>During long journeys, take regular breaks in good time so you get enough rest.</p>
<p> Attention Assist Inoperative</p>	<p>ATTENTION ASSIST is inoperative.</p> <ul style="list-style-type: none"> <li>► Visit a qualified specialist workshop.</li> </ul>
<p>Traffic Sign Assist Currently Unavailable See Operator's Manual</p>	<p>Traffic Sign Assist is deactivated and temporarily inoperative. Possible causes are:</p> <ul style="list-style-type: none"> <li>• the windshield in the camera's field of vision is dirty</li> <li>• visibility is impaired due to heavy rain, snow or fog</li> </ul> <p>► Clean the windshield.</p> <p>If the system detects that the camera is fully operational, the display message disappears. Traffic Sign Assist is operational again.</p>
<p>Traffic Sign Assist Inoperative</p>	<p>Traffic Sign Assist is malfunctioning.</p> <ul style="list-style-type: none"> <li>► Visit a qualified specialist workshop.</li> </ul>
<p> Off</p>	<p>The HOLD function is deactivated. The vehicle is skidding. A warning tone also sounds.</p> <ul style="list-style-type: none"> <li>► Reactivate the HOLD function later (► page 165).</li> </ul>





Display messages	Possible causes/consequences and ► Solutions
<p>Active Lane Keeping Assist Currently Unavailable See Operator's Manual</p>	<p>Active Lane Keeping Assist is deactivated and temporarily inoperative.</p> <p>Possible causes are:</p> <ul style="list-style-type: none"> <li>• the windshield in the camera's field of vision is dirty</li> <li>• visibility is impaired due to heavy rain, snow or fog</li> <li>• there have been no lane markings for an extended period</li> <li>• the lane markings are worn away, dark or covered up, e.g. by dirt or snow</li> </ul> <p>When the causes stated above no longer apply, the display message disappears.</p> <p>Active Lane Keeping Assist is operational again.</p> <p>If the display message does not disappear:</p> <ul style="list-style-type: none"> <li>► Pull over and stop the vehicle safely as soon as possible, paying attention to road and traffic conditions.</li> <li>► Secure the vehicle against rolling away (▷ page 146).</li> <li>► Clean the windshield.</li> </ul>
<p>Active Lane Keeping Assist Inoperative</p>	<p>Active Lane Keeping Assist is malfunctioning.</p> <ul style="list-style-type: none"> <li>► Visit a qualified specialist workshop.</li> </ul>
<p>Active Blind Spot Assist Currently Unavailable See Operator's Manual</p>	<p>Active Blind Spot Assist is temporarily inoperative.</p> <p>Possible causes are:</p> <ul style="list-style-type: none"> <li>• the radar sensor system is outside the operating temperature range</li> <li>• the radar sensor system is temporarily inoperative, e.g. due to electromagnetic radiation emitted by nearby TV or radio stations or other sources of electromagnetic radiation</li> </ul> <p>The yellow  indicator lamps also light up in the exterior mirrors.</p> <p>When the causes stated above no longer apply, the display message disappears.</p> <p>Active Blind Spot Assist is operational again.</p> <p>If the display message does not disappear:</p> <ul style="list-style-type: none"> <li>► Pull over and stop the vehicle safely as soon as possible, paying attention to road and traffic conditions.</li> <li>► Secure the vehicle against rolling away (▷ page 146).</li> <li>► Clean the sensors (▷ page 275).</li> <li>► Restart the engine.</li> </ul>
<p>Active Blind Spot Assist Inoperative</p>	<p>Active Blind Spot Assist is malfunctioning.</p> <p>The yellow  indicator lamps also light up in the exterior mirrors.</p> <ul style="list-style-type: none"> <li>► Visit a qualified specialist workshop.</li> </ul>

Display messages	Possible causes/consequences and ► Solutions
Active Parking Assist Canceled	<p>The driver's door is open and the driver's seat belt has not been fastened.</p> <ul style="list-style-type: none"> <li>► Repeat the parking process with the seat belt fastened and the driver's door closed.</li> </ul> <p>You have inadvertently touched the multifunction steering wheel while steering intervention was active.</p> <ul style="list-style-type: none"> <li>► While steering intervention is active, make sure that the multifunction steering wheel is not touched unintentionally.</li> </ul> <p>The vehicle has started to skid and ESP® has intervened.</p> <ul style="list-style-type: none"> <li>► Use Active Parking Assist again later (▷ page 175).</li> </ul>
Active Parking Assist Inoperative	<p>You have just carried out a large number of turning or parking maneuvers.</p> <p>Active Parking Assist will become available again after approximately ten minutes (▷ page 175).</p> <ul style="list-style-type: none"> <li>► Pull over and stop the vehicle safely as soon as possible, paying attention to road and traffic conditions.</li> <li>► Switch off and restart the engine.</li> </ul> <p>If the multifunction display still shows the display message:</p> <ul style="list-style-type: none"> <li>► Visit a qualified specialist workshop.</li> </ul> <p>Active Parking Assist is malfunctioning.</p> <ul style="list-style-type: none"> <li>► Visit a qualified specialist workshop.</li> </ul>
Active Parking Assist Finished	<p>The vehicle is parked. A warning tone also sounds.</p> <p>The display message disappears automatically.</p>
Active Distance Assist Off	<p>Active Distance Assist DISTRONIC was deactivated (▷ page 156).</p> <p>If it was deactivated automatically, a warning tone also sounds.</p>
Active Distance Assist Now Available	<p>Active Distance Assist DISTRONIC is operational again after having been temporarily unavailable. You can now reactivate Active Distance Assist DISTRONIC (▷ page 156).</p>

Display messages	Possible causes/consequences and ► Solutions
<p>Active Distance Assist Currently Unavailable See Operator's Manual</p>	<p>Active Distance Assist DISTRONIC is temporarily inoperative. Active Steering Assist is also temporarily inoperative.</p> <p>Possible causes are:</p> <ul style="list-style-type: none"> <li>• the radar sensor system is temporarily inoperative, e.g. due to electromagnetic radiation emitted by nearby TV or radio stations or other sources of electromagnetic radiation</li> <li>• the system is outside the operating temperature range</li> <li>• the on-board voltage is too low</li> </ul> <p>A warning tone also sounds.</p> <p>When the causes stated above no longer apply, the display message disappears.</p> <p>Active Distance Assist DISTRONIC is operational again.</p> <p>If the display message does not disappear:</p> <ul style="list-style-type: none"> <li>► Pull over and stop the vehicle safely as soon as possible, paying attention to road and traffic conditions.</li> <li>► Secure the vehicle against rolling away (▷ page 146).</li> <li>► Restart the engine.</li> </ul>
<p>Active Distance Assist Inoperative</p>	<p>Active Distance Assist DISTRONIC is faulty.</p> <p>The following may have also failed:</p> <ul style="list-style-type: none"> <li>• Brake Assist with cross-traffic function</li> <li>• Active Brake Assist with cross-traffic function</li> <li>• Active Steering Assist</li> </ul> <p>A warning tone also sounds.</p> <ul style="list-style-type: none"> <li>► Visit a qualified specialist workshop.</li> </ul>
<p>Act. Distance Assist Suspended</p>	<p>You have depressed the accelerator pedal. Active Distance Assist DISTRONIC is no longer controlling the speed of the vehicle.</p> <ul style="list-style-type: none"> <li>► Remove your foot from the accelerator pedal.</li> </ul>
<p>Distance Assist - - - mph</p>	<p>A condition for activating Active Distance Assist DISTRONIC has not been met.</p> <ul style="list-style-type: none"> <li>► Check the activation conditions for Active Distance Assist DISTRONIC (▷ page 156).</li> </ul>

Display messages	Possible causes/consequences and ► Solutions
Active Steering Assist Currently Unavailable See Operator's Manual	<p>Active Steering Assist is temporarily inoperative. Possible causes are:</p> <ul style="list-style-type: none"> <li>• the windshield in the camera's field of vision is dirty</li> <li>• visibility is impaired due to heavy rain, snow or fog</li> <li>• there have been no lane markings for an extended period</li> <li>• the lane markings are worn away, dark or covered up, e.g. by dirt or snow</li> </ul> <p>When the causes stated above no longer apply, the display message disappears. Active Steering Assist is operational again. If the display message does not disappear:</p> <ul style="list-style-type: none"> <li>► Pull over and stop the vehicle safely as soon as possible, paying attention to road and traffic conditions.</li> <li>► Secure the vehicle against rolling away (▷ page 146).</li> <li>► Clean the windshield.</li> </ul>
Active Steering Assist Inoperative	<p>Active Steering Assist is faulty. However, the Active Distance Assist DISTRONIC functions are still available. A warning tone also sounds.</p> <ul style="list-style-type: none"> <li>► Visit a qualified specialist workshop.</li> </ul>
Cruise Control Off	<p>Cruise control has been deactivated. If a warning tone also sounds, cruise control has deactivated automatically (▷ page 154).</p>
Cruise Control - - - mph	<p>Cruise control cannot be activated, since not all of the activation conditions have been met.</p> <ul style="list-style-type: none"> <li>► Check the activation conditions for cruise control (▷ page 154).</li> </ul>
Cruise Control Inoperative	<p>Cruise control is malfunctioning. A warning tone also sounds.</p> <ul style="list-style-type: none"> <li>► Visit a qualified specialist workshop.</li> </ul>

Tires	
Display messages	Possible causes/consequences and ► Solutions
Please Correct Tire Pressure	<p>The tire pressure is too low in at least one of the tires, or the tire pressure difference between the wheels is too great.</p> <ul style="list-style-type: none"> <li>► Check the tire pressures at the next opportunity (▷ page 299).</li> <li>► If necessary, correct the tire pressure.</li> <li>► Restart the tire pressure monitor (▷ page 301).</li> </ul>
Tire Pressure Soon	<p>The tire pressure in one or more tires has dropped significantly. The wheel position is shown in the multifunction display. A warning tone also sounds.</p> <p> <b>WARNING</b></p> <p>Tire pressures that are too low pose the following hazards:</p> <ul style="list-style-type: none"> <li>• they may burst, especially as the load and vehicle speed increase</li> <li>• they may wear excessively and/or unevenly, which may greatly impair tire traction.</li> <li>• the driving characteristics, as well as steering and braking, may be greatly impaired</li> </ul> <p>There is a risk of an accident.</p> <ul style="list-style-type: none"> <li>► Stop the vehicle without making any sudden steering or braking maneuvers. Pay attention to the traffic conditions as you do so.</li> <li>► Secure the vehicle against rolling away (▷ page 146).</li> <li>► Check the tires and, if necessary, follow the instructions for a flat tire (▷ page 278).</li> <li>► Check the tire pressure (▷ page 299).</li> <li>► If necessary, correct the tire pressure.</li> </ul>
Warning Tire Malfunction	<p>The tire pressure in one or more tires has dropped suddenly. The wheel position is shown in the multifunction display.</p> <p> <b>WARNING</b></p> <p>Driving with a flat tire poses a risk of the following hazards:</p> <ul style="list-style-type: none"> <li>• a flat tire affects the ability to steer or brake the vehicle</li> <li>• you could lose control of the vehicle.</li> <li>• continued driving with a flat tire will cause excessive heat build-up and possibly a fire</li> </ul> <p>There is a risk of an accident.</p> <ul style="list-style-type: none"> <li>► Stop the vehicle without making any sudden steering or braking maneuvers. Pay attention to the traffic conditions as you do so.</li> <li>► Secure the vehicle against rolling away (▷ page 146).</li> <li>► Check the tires and, if necessary, follow the instructions for a flat tire (▷ page 278).</li> </ul>









Display messages	Possible causes/consequences and ► Solutions
Tire Press. Monitor Currently Unavailable	<p>Because there is interference from a strong source of radio waves, no signals from the tire pressure sensors are detected. The tire pressure monitor is temporarily malfunctioning.</p> <p>► Drive on. The tire pressure monitor restarts automatically as soon as the problem has been resolved.</p>
TirePress. Sensor(s) Missing	<p>There is no signal from the tire pressure sensor of one or several wheels. The pressure of the affected tire does not appear in the multifunction display.</p> <p>► Have the faulty tire pressure sensor replaced at a qualified specialist workshop.</p>
Tire Pressure Monitor Inoperative No Wheel Sensors	<p>The wheels mounted do not have a suitable tire pressure sensor. The tire pressure monitor is deactivated.</p> <p>► Mount wheels with suitable tire pressure sensors. The tire pressure monitor is activated automatically after driving for a few minutes.</p>
Tire Press. Monitor Inoperative	<p>The tire pressure monitor is faulty.</p> <p>► Visit a qualified specialist workshop.</p>





## Vehicle

Display messages	Possible causes/consequences and ► Solutions
Shift to 'P' or 'N' to Start Engine	<p>You have attempted to start the engine with the transmission in position <b>R</b> or <b>D</b>.</p> <p>► Shift the transmission to position <b>P</b> or <b>N</b>.</p>
Apply Brake to Shift from 'P'	<p>You have attempted to shift the transmission to position <b>D</b>, <b>R</b> or <b>N</b> without depressing the brake pedal.</p> <p>► Depress the brake pedal.</p>
To Shift out of P or N, Depress Brake and Switch on Engine	<p>You have attempted to shift the transmission out of position <b>P</b> or <b>N</b> into another transmission position with the engine switched off.</p> <p>► Depress the brake pedal. ► Start the engine.</p>
Driver's Door Open & Transmission Not in P Risk of Vehicle Rolling Away	<p>The driver's door is not fully closed and the transmission is in position <b>R</b>, <b>N</b> or <b>D</b>. A warning tone also sounds.</p> <p><b>⚠ WARNING</b></p> <p>The vehicle may roll away. There is a risk of an accident.</p> <p>► When parking the vehicle, shift the transmission to position <b>P</b>.</p>



Display messages	Possible causes/consequences and ► Solutions
Only Select Park (P) When Vehicle is Stationary	<p>The vehicle is moving.</p> <ul style="list-style-type: none"> <li>► Pull over and stop the vehicle safely as soon as possible, paying attention to road and traffic conditions.</li> <li>► Shift the transmission to position <b>P</b>.</li> </ul>
Apply Brake to Select R	<p>You have attempted to shift from position <b>D</b> to position <b>R</b>.</p> <ul style="list-style-type: none"> <li>► Depress the brake pedal.</li> <li>► Shift the transmission to position <b>R</b>.</li> </ul>
Service Required Do Not Shift Gears Visit Dealer	<p>You cannot change the transmission position due to a malfunction. A warning tone also sounds.</p> <p>If transmission position <b>D</b> is selected:</p> <ul style="list-style-type: none"> <li>► Drive to a qualified specialist workshop without shifting the transmission from position <b>D</b>.</li> </ul> <p>If position <b>R</b>, <b>N</b> or <b>P</b> is selected:</p> <ul style="list-style-type: none"> <li>► Notify a qualified specialist workshop or breakdown service.</li> </ul>
Reversing Not Possible Service Required	<p>You can no longer shift to transmission position <b>R</b> due to a malfunction.</p> <p>Transmission positions <b>P</b>, <b>N</b> or <b>D</b> continue to be available. A warning tone also sounds.</p> <ul style="list-style-type: none"> <li>► Visit a qualified specialist workshop.</li> </ul>
Transmission Malfunction Stop	<p>A malfunction has occurred in the mechanical transmission components. A warning tone also sounds. The transmission shifts automatically to position <b>N</b>.</p> <ul style="list-style-type: none"> <li>► Pull over and stop the vehicle safely as soon as possible, paying attention to road and traffic conditions.</li> <li>► Shift the transmission to position <b>P</b>.</li> <li>► Secure the vehicle against rolling away (► page 146).</li> <li>► Notify a qualified specialist workshop or breakdown service.</li> </ul>
Stop Vehicle Leave Engine Running Wait Transmission Cooling	<p>The transmission has overheated. Pulling away can be temporarily impaired or not possible.</p> <ul style="list-style-type: none"> <li>► Pull over and stop the vehicle safely as soon as possible, paying attention to road and traffic conditions. Do not continue driving under any circumstances.</li> <li>► Wait until the display message disappears before pulling away.</li> </ul>
Auxiliary Battery Malfunction	<p>The auxiliary battery for the automatic transmission is no longer being charged.</p> <ul style="list-style-type: none"> <li>► Visit a qualified specialist workshop at the next opportunity.</li> <li>► Until then, always shift the transmission to position <b>P</b> before you switch off the engine.</li> <li>► Before leaving the vehicle, apply the electric parking brake.</li> </ul>









Display messages	Possible causes/consequences and ► Solutions
	<p>The trunk lid is open.</p> <ul style="list-style-type: none"> <li>► Close the trunk lid.</li> </ul>
	<p>The hood is open.</p> <p> <b>WARNING</b></p> <p>The open hood may block your view when the vehicle is in motion. There is a risk of an accident.</p> <ul style="list-style-type: none"> <li>► Pull over and stop the vehicle safely as soon as possible, paying attention to road and traffic conditions.</li> <li>► Secure the vehicle against rolling away (► page 146).</li> <li>► Close the hood.</li> </ul>
	<p>At least one door is open. A warning tone also sounds.</p> <ul style="list-style-type: none"> <li>► Close all the doors.</li> </ul>
 <p>Power Steering Malfunction See Operator's Manual</p>	<p>The power steering is malfunctioning. A warning tone also sounds.</p> <p> <b>WARNING</b></p> <p>You will need to use more force to steer. There is a risk of an accident.</p> <ul style="list-style-type: none"> <li>► Check whether you are able to apply the extra force required.</li> <li>► <b>If you are able to steer safely:</b> carefully drive on to a qualified specialist workshop.</li> <li>► <b>If you are unable to steer safely:</b> do not drive on. Contact the nearest qualified specialist workshop.</li> </ul>
 <p>Trunk Partition Open</p>	<p>The trunk partition is open.</p> <p>The trunk is loaded too high and the load is preventing automatic closing of the trunk partition.</p> <ul style="list-style-type: none"> <li>► Stow the load such that the trunk partition can close unhindered and is not pushed upwards.</li> <li>► Close the trunk partition (► page 93).</li> </ul>
<p>Phone No Service</p>	<p>Your vehicle is outside the network provider's transmitter/receiver range.</p> <ul style="list-style-type: none"> <li>► Wait until the mobile phone operational readiness symbol appears in the multifunction display.</li> </ul>
 <p>Decrease Speed</p>	<p>You wanted to open the roof while the vehicle was in motion.</p> <ul style="list-style-type: none"> <li>► Pull over and stop the vehicle safely as soon as possible, paying attention to road and traffic conditions.</li> <li>► Open the roof (► page 91).</li> </ul>

Display messages	Possible causes/consequences and ► Solutions
 <p>Vario-Roof Lowering</p>	<p>The roof is not fully opened or closed. The hydraulics are depressurized.</p> <ul style="list-style-type: none"> <li>► Fully open or close the roof (▷ page 91).</li> </ul>
 <p>Open/Close Vario-Roof Completely</p>	<p>The roof is not locked.</p> <ul style="list-style-type: none"> <li>► Pull over and stop the vehicle safely as soon as possible, paying attention to road and traffic conditions.</li> <li>► Push or pull and hold the roof switch until the roof is fully open or closed (▷ page 91).</li> </ul>
 <p>Start Engine See Operator's Manual</p>	<p>The on-board voltage is too low.</p> <ul style="list-style-type: none"> <li>► Start the engine.</li> <li>► After approximately ten seconds, repeat the opening or closing procedure (▷ page 91).</li> </ul> <p>The roof has been opened and closed several times in a row. The roof drive has been switched off automatically for safety reasons. You can open and close the roof again after approximately ten minutes.</p> <ul style="list-style-type: none"> <li>► Switch off the ignition and turn it back on.</li> <li>► Repeat the opening or closing procedure (▷ page 91).</li> </ul>
<p>Close Rear Side Windows</p>	<p>You leave the vehicle and at least one rear side window is open.</p> <ul style="list-style-type: none"> <li>► Close the side windows (▷ page 88).</li> </ul>
 <p>Check Washer Fluid</p>	<p>The washer fluid level in the washer fluid reservoir has dropped below the minimum.</p> <ul style="list-style-type: none"> <li>► Add washer fluid (▷ page 268).</li> </ul>
<p>Wiper Malfunctioning</p>	<p>The windshield wipers are malfunctioning.</p> <ul style="list-style-type: none"> <li>► Visit a qualified specialist workshop.</li> </ul>
<p>Hazard Warning Flashers Malfunctioning</p>	<p>The hazard warning lamps are faulty.</p> <ul style="list-style-type: none"> <li>► Visit a qualified specialist workshop.</li> </ul>

### SmartKey

Display messages	Possible causes/consequences and ► Solutions
 <p>Key Does Not Belong to Vehicle</p>	<p>You have put the wrong SmartKey in the ignition lock.</p> <ul style="list-style-type: none"> <li>► Use the correct SmartKey.</li> </ul>
 <p>Take Your Key from Ignition</p>	<p>The SmartKey is in the ignition lock.</p> <ul style="list-style-type: none"> <li>► Remove the SmartKey.</li> </ul>

Display messages	Possible causes/consequences and ► Solutions
 <p>Obtain a New Key</p>	<p>The SmartKey needs to be replaced.</p> <ul style="list-style-type: none"> <li>► Visit a qualified specialist workshop.</li> </ul>
 <p>Replace Key Battery</p>	<p>The SmartKey battery is discharged.</p> <ul style="list-style-type: none"> <li>► Change the battery (► page 77).</li> </ul>
 <p>Don't Forget Your Key</p>	<p>The SmartKey is not in the ignition lock. You have opened the driver's door with the engine switched off.</p> <p>The multifunction display shows the display message a maximum of 60 seconds and is simply a reminder.</p> <ul style="list-style-type: none"> <li>► Take the SmartKey with you when you leave the vehicle.</li> </ul>
 <p>Key Not Detected (red display message)</p>	<p>The SmartKey is not in the vehicle.</p> <p>A warning tone also sounds.</p> <p>If the engine is switched off, you can no longer lock the vehicle centrally or start the engine.</p> <ul style="list-style-type: none"> <li>► Pull over and stop the vehicle safely as soon as possible, paying attention to road and traffic conditions.</li> <li>► Secure the vehicle against rolling away (► page 146).</li> <li>► Locate the SmartKey.</li> <li>► Press <input type="button" value="OK"/> on the steering wheel to confirm the display message.</li> </ul> <p>Because there is interference from a strong source of radio waves, the SmartKey is not detected whilst the engine is running.</p> <p>A warning tone also sounds.</p> <ul style="list-style-type: none"> <li>► Pull over and stop the vehicle safely as soon as possible, paying attention to road and traffic conditions.</li> <li>► Secure the vehicle against rolling away (► page 146).</li> <li>► Insert the SmartKey into the ignition lock and bring into key mode.</li> </ul>
 <p>Key Not Detected (white display message)</p>	<p>The SmartKey is currently undetected.</p> <ul style="list-style-type: none"> <li>► Change the location of the SmartKey in the vehicle.</li> </ul> <p>If the SmartKey still cannot be detected:</p> <ul style="list-style-type: none"> <li>► Insert the SmartKey into the ignition lock and turn it to the desired position.</li> </ul>
 <p>Remove 'Start' Button and Insert Key</p>	<p>The SmartKey is continually undetected.</p> <p>KEYLESS-GO is temporarily malfunctioning or is defective. A warning tone also sounds.</p> <ul style="list-style-type: none"> <li>► Insert the SmartKey into the ignition lock and turn it to the desired position.</li> <li>► Visit a qualified specialist workshop.</li> </ul>

## Warning and indicator lamps

### General notes

Some systems carry out a self-diagnosis when the ignition is switched on. Therefore, some indicator and warning lamps may light up or flash temporarily. This behavior is non-critical. These indicator and warning lamps only indicate a malfunction if they light up or flash after starting the engine or whilst driving.

### Safety

#### Seat belts

##### Warning/ indicator lamp

##### ▷ Signal type Possible causes/consequences and ► Solutions



- ▷ After starting the engine, the red seat belt warning lamp lights up for six seconds.  
The seat belt warning lamp reminds the driver and front passenger to fasten their seat belts.
- Fasten your seat belt (▷ page 44).



- ▷ After starting the engine, the red seat belt warning lamp lights up. In addition, a warning tone sounds for up to six seconds.  
The driver's seat belt is not fastened.
- Fasten your seat belt (▷ page 44).  
The warning tone ceases.

Warning/  
indicator  
lamp

## ▷ Signal type

## Possible causes/consequences and ► Solutions



▷ The red seat belt warning lamp lights up after the engine starts, as soon as the driver's or the front-passenger door is closed.

The driver or front passenger has not fastened their seat belt.

- Fasten your seat belt (▷ page 44).  
The warning lamp goes out.

There are objects on the front-passenger seat.

- Remove the objects from the front-passenger seat and stow them in a secure place.  
The warning lamp goes out.



▷ The red seat belt warning lamp flashes and an intermittent audible warning sounds.

The driver or front passenger has not fastened their seat belt. The vehicle is being driven faster than 15 mph (25 km/h) or has briefly been driven faster than 15 mph (25 km/h).

- Fasten your seat belt (▷ page 44).  
The warning lamp goes out and the intermittent warning tone ceases.

There are objects on the front-passenger seat. The vehicle is being driven faster than 15 mph (25 km/h) or has briefly been driven faster than 15 mph (25 km/h).

- Remove the objects from the front-passenger seat and stow them in a secure place.  
The warning lamp goes out and the intermittent warning tone ceases.

## Safety systems

Warning/  
indicator  
lamp

## ▷ Signal type

## Possible causes/consequences and ▶ Solutions



▷ **BRAKE** (USA only), **(D)** (Canada only): the red brake system warning lamp is lit while the engine is running.  
A warning tone also sounds.

**WARNING**

The brake boosting effect is malfunctioning and the braking characteristics may be affected.

There is a risk of an accident.

- ▶ Pull over and stop the vehicle safely as soon as possible, paying attention to road and traffic conditions. Do not continue driving under any circumstances.
- ▶ Secure the vehicle against rolling away (▷ page 146).
- ▶ Consult a qualified specialist workshop.
- ▶ Observe the additional display messages in the multifunction display.



▷ **BRAKE** (USA only) or **(D)** (Canada only): the red brake system warning lamp is lit while the engine is running. A warning tone also sounds.

**WARNING**

There is not enough brake fluid in the brake fluid reservoir.

The braking effect may be impaired.

There is a risk of an accident.

- ▶ Pull over and stop the vehicle safely as soon as possible, paying attention to road and traffic conditions. Do not continue driving under any circumstances.
- ▶ Secure the vehicle against rolling away (▷ page 146).
- ▶ Do not add brake fluid. Adding more will not correct the malfunction.
- ▶ Consult a qualified specialist workshop.
- ▶ Observe the additional display messages in the multifunction display.



▷ USA only: the red brake system warning lamp is lit while the engine is running. The multifunction display also shows a display message with the

The brake pads/linings have reached their wear limit.

- ▶ Visit a qualified specialist workshop.

Warning/  
indicator  
lamp

## ▷ Signal type

## Possible causes/consequences and ► Solutions



▷ The yellow ABS warning lamp is lit while the engine is running. ABS (anti-lock braking system) is malfunctioning. If there is an additional warning tone, the EBD (electronic brake force distribution) is malfunctioning. Other driving systems and driving safety systems may also malfunction.

**WARNING**

The brake system continues to function normally, but without the functions listed above. The front and rear wheels could therefore lock if you perform a full brake application, for example.

The steerability and braking characteristics may be severely affected. The braking distance in an emergency braking situation can increase.

If ESP® is not operational, ESP® is unable to stabilize the vehicle.

There is an increased risk of skidding and an accident.

- ▶ Observe the additional display messages in the multifunction display.
- ▶ Drive on carefully.
- ▶ Visit a qualified specialist workshop immediately.

If the ABS control unit is defective, there is also a possibility that other systems, such as the navigation system or the automatic transmission, will not be available.

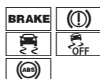

▷ **BRAKE** (USA only), (Canada only): the red brake warning lamp and the yellow ESP®, ESP® OFF and ABS warning lamps are lit while the engine is running.

ABS and ESP® are malfunctioning.

Other driving systems and driving safety systems may also malfunction.

**WARNING**

The brake system continues to function normally, but without the functions listed above. The front and rear wheels could therefore lock if you perform a full brake application, for example.





The steerability and braking characteristics may be severely affected. The braking distance in an emergency braking situation can increase.

If ESP® is not operational, ESP® is unable to stabilize the vehicle.

There is an increased risk of skidding and an accident.

- ▶ Observe the additional display messages in the multifunction display.
- ▶ Drive on carefully.
- ▶ Visit a qualified specialist workshop immediately.



Warning/ indicator lamp	▷ Signal type Possible causes/consequences and ▶ Solutions
	<p>▷ The yellow ESP<sup>®</sup> warning lamp flashes while the vehicle is in motion. ESP<sup>®</sup> or traction control has intervened because there is a risk of skidding or at least one wheel has started to spin. Cruise control or Active Distance Assist DISTRONIC is deactivated.</p> <ul style="list-style-type: none"> <li>▶ When pulling away, only depress the accelerator pedal as far as necessary.</li> <li>▶ Ease off the accelerator pedal while the vehicle is in motion.</li> <li>▶ Adapt your driving style to suit the road and weather conditions.</li> <li>▶ Do not deactivate ESP<sup>®</sup>.</li> </ul> <p>In rare cases (▷ page 68) it may be best to deactivate ESP<sup>®</sup>. Observe the important safety notes on ESP<sup>®</sup> (▷ page 66).</p>
	<p>▷ The yellow ESP<sup>®</sup> and ESP<sup>®</sup> OFF warning lamps are lit while the engine is running. ESP<sup>®</sup> is malfunctioning. Other driving systems and driving safety systems may also malfunction.</p> <p> <b>WARNING</b></p> <p>The brake system continues to function normally, but without the functions listed above. The braking distance in an emergency braking situation can thus increase. If ESP<sup>®</sup> is not operational, ESP<sup>®</sup> is unable to stabilize the vehicle. There is an increased risk of skidding and an accident.</p> <ul style="list-style-type: none"> <li>▶ Observe the additional display messages in the multifunction display.</li> <li>▶ Drive on carefully.</li> <li>▶ Visit a qualified specialist workshop immediately.</li> </ul>
	<p>▷ The yellow ESP<sup>®</sup> OFF warning lamp is lit while the engine is running or the ECO start/stop function is activated. ESP<sup>®</sup> is deactivated.</p> <p> <b>WARNING</b></p> <p>If ESP<sup>®</sup> is switched off, ESP<sup>®</sup> is unable to stabilize the vehicle. Further driving systems or driving safety systems are thus restricted, e.g. Active Blind Spot Assist. The system does not perform course-correcting brake applications. There is an increased risk of skidding and an accident.</p> <ul style="list-style-type: none"> <li>▶ Reactivate ESP<sup>®</sup>.</li> </ul> <p>In rare cases (▷ page 68) it may be best to deactivate ESP<sup>®</sup>. Observe the important safety notes on ESP<sup>®</sup> (▷ page 66).</p> <ul style="list-style-type: none"> <li>▶ Adapt your driving style to suit the road and weather conditions.</li> </ul> <p>If ESP<sup>®</sup> cannot be activated:</p> <ul style="list-style-type: none"> <li>▶ Drive on carefully.</li> <li>▶ Have ESP<sup>®</sup> checked at a qualified specialist workshop.</li> </ul>

Warning/  
indicator  
lamp

## ▷ Signal type

## Possible causes/consequences and ► Solutions

SPORT

▷ Mercedes-AMG vehicles only:

The yellow SPORT handling mode warning lamp is lit while the engine is running. SPORT handling mode is activated.



 **WARNING**

When SPORT handling mode is switched on, ESP® is unable to stabilize the vehicle.

There is an increased risk of skidding and an accident.

- Only switch to SPORT handling mode in accordance with the conditions described in the "Activating/deactivating ESP®" section (▷ page 68).

PARK 

▷  (USA only),  (Canada only): the red indicator lamp for the electric parking brake flashes or is lit and/or the yellow warning lamp for the electric parking brake is lit.

- Observe the additional display messages in the multifunction display.



▷ The red restraint system warning lamp is lit while the engine is running. The restraint system is malfunctioning.

 **WARNING**

The air bags or Emergency Tensioning Devices may either be triggered unintentionally or, in the event of an accident, may not be triggered.

There is an increased risk of injury.

- Observe the additional display messages in the multifunction display.
- Drive on carefully.
- Contact a qualified specialist workshop and have the restraint system checked.

For further information about the restraint system, see (▷ page 41).

## Engine

Warning/  
indicator  
lamp

## ▷ Signal type

## Possible causes/consequences and ► Solutions



▷ The yellow Check Engine warning lamp lights up while the engine is running. There may be a malfunction, for example:

- in the engine management
- in the fuel injection system
- in the exhaust system
- in the ignition system
- in the fuel system

The emission limit values may be exceeded and the engine may be in emergency mode.

► Visit a qualified specialist workshop immediately.

In some states, you must immediately visit a qualified specialist workshop as soon as the yellow Check Engine warning lamp lights up. This is due to the legal requirements in effect in these states. If in doubt, check whether such legal regulations apply in the state in which you are currently driving.



▷ The yellow reserve fuel warning lamp lights up while the engine is running. The fuel level has dropped into the reserve range.

► Refuel at the nearest gas station.



▷ The yellow reserve fuel warning lamp flashes while the vehicle is in motion. In addition, the  Check Engine warning lamp may light up. The fuel filler cap is not closed correctly or the fuel system is leaking.

► Check that the fuel filler cap is correctly closed.

► **If the fuel filler cap is not correctly closed:** close the fuel filler cap.

► **If the fuel filler cap is closed:** visit a qualified specialist workshop.



▷ The red coolant warning lamp lights up while the engine is running and the coolant temperature gage is at the start of the scale.

The temperature sensor for the coolant temperature gage is malfunctioning.

The coolant temperature is no longer being monitored. There is a risk of engine damage if the coolant temperature is too high.

► Pull over and stop the vehicle safely and switch off the engine, paying attention to road and traffic conditions. Do not continue driving under any circumstances.

► Secure the vehicle against rolling away (▷ page 146).

► Consult a qualified specialist workshop.

Warning/  
indicator  
lamp

## ▷ Signal type

## Possible causes/consequences and ► Solutions



▷ The red coolant warning lamp comes on while the engine is running.

The coolant level is too low.

If the coolant level is correct, the airflow to the engine radiator may be blocked or the electric engine radiator fan may be defective.

The coolant is too hot and the engine is no longer being cooled sufficiently.

- ▶ Observe the additional display messages in the multifunction display.
- ▶ Pull over and stop the vehicle safely and switch off the engine, paying attention to road and traffic conditions.
- ▶ Secure the vehicle against rolling away (▷ page 146).
- ▶ Leave the vehicle and keep a safe distance from the vehicle until the engine has cooled down.
- ▶ Check the coolant level and add coolant, observing the warning notes (▷ page 267).
- ▶ If you have to add coolant frequently, have the engine cooling system checked.
- ▶ Make sure that the air supply to the engine radiator is not blocked, e.g. by snow, slush or ice.
- ▶ Do not start the engine again until the coolant temperature gage is below the **H** marking (▷ page 191). Otherwise, the engine could be damaged.
- ▶ Drive to the nearest qualified specialist workshop.
- ▶ Avoid heavy loads on the engine as you do so, e.g. driving in mountainous terrain and stop-and-go traffic.



▷ The red coolant warning lamp comes on while the engine is running.

The coolant temperature gage has exceeded the **H** marking (▷ page 191). The airflow to the engine radiator may be blocked or the coolant level may be too low.

**WARNING**

The engine is not being cooled sufficiently and may be damaged.

Do not drive when your engine is overheated. This can cause some fluids which may have leaked into the engine compartment to catch fire.

Steam from the overheated engine can also cause serious burns which can occur just by opening the hood.

There is a risk of injury.

- ▶ Observe the additional display messages in the multifunction display.
- ▶ Pull over and stop the vehicle safely and switch off the engine, paying attention to road and traffic conditions.
- ▶ Secure the vehicle against rolling away (▷ page 146).
- ▶ Leave the vehicle and keep a safe distance from the vehicle until the engine has cooled down.
- ▶ Check the coolant level and add coolant, observing the warning notes (▷ page 267).
- ▶ If you have to add coolant frequently, have the engine cooling system checked.

**Warning/  
indicator  
lamp****▷ Signal type****Possible causes/consequences and ▶ Solutions**

- ▶ Make sure that the air supply to the engine radiator is not blocked, e.g. by snow, slush or ice.
- ▶ If the coolant temperature gage is below the **H** marking (▷ page 191), drive on to the next qualified specialist workshop.
- ▶ Avoid heavy loads on the engine as you do so, e.g. driving in mountainous terrain and stop-and-go traffic.

**Driving systems****Warning/  
indicator  
lamp****▷ Signal type****Possible causes/consequences and ▶ Solutions**

▷ The red distance warning lamp lights up while the vehicle is in motion. A warning tone also sounds.

You are approaching a vehicle, a pedestrian or a stationary obstacle in your line of travel at too high a speed.

- ▶ Be prepared to brake immediately.
- ▶ Pay careful attention to the traffic situation. You may have to brake or take evasive action.

Further information on Active Distance Assist DISTRONIC (▷ page 156).

Further information on Active Brake Assist (▷ page 63).

Further information on Active Brake Assist with cross-traffic function (▷ page 70).

## Tires

Warning/  
indicator  
lamp

## ▷ Signal type

## Possible causes/consequences and ► Solutions



▷ The yellow tire pressure monitor warning lamp (pressure loss/malfunction) is lit.

The tire pressure monitor has detected a loss of pressure in at least one of the tires.

 **WARNING**

Tire pressures that are too low pose the following hazards:

- they may burst, especially as the load and vehicle speed increase
- they may wear excessively and/or unevenly, which may greatly impair tire traction.
- the driving characteristics, as well as steering and braking, may be greatly impaired

There is a risk of an accident.

- ▶ Stop the vehicle without making any sudden steering or braking maneuvers. Pay attention to the traffic conditions as you do so.
- ▶ Secure the vehicle against rolling away (▷ page 146).
- ▶ Observe the additional display messages in the multifunction display.
- ▶ Check the tires and, if necessary, follow the instructions for a flat tire (▷ page 278).
- ▶ Check the tire pressure (▷ page 299).
- ▶ If necessary, correct the tire pressure.



▷ The yellow tire pressure monitor warning lamp (pressure loss/malfunction) flashes for approximately one minute and then remains lit.

The tire pressure monitor is faulty.

 **WARNING**

The system is possibly unable to recognize or register low tire pressure.

There is a risk of an accident.

- ▶ Observe the additional display messages in the multifunction display.
- ▶ Visit a qualified specialist workshop immediately.

## General notes

The multimedia system section in this Operator's Manual describes the basic principles for operation. More information can be found in the Digital Operator's Manual.

## Important safety notes

### WARNING

If you operate information systems and communication equipment integrated in the vehicle when driving, you may be distracted from the traffic situation. You could also lose control of the vehicle. There is a risk of an accident.

Only operate this equipment when the traffic situation permits. If you are not sure that this is possible, park the vehicle paying attention to traffic conditions and operate the equipment when the vehicle is stationary.

You must observe the legal requirements for the country in which you are currently driving when operating the multimedia system.

The multimedia system calculates the route to the destination without taking the following into account, for example:

- traffic lights
- stop and yield signs
- parking or stopping restrictions
- road narrowing
- other road and traffic rules and regulations

The multimedia system may give incorrect navigation recommendations if the actual street/traffic situation does not correspond with the digital map's data.

For example:

- a diverted route
- the road layout or the direction of a one-way street has been changed

For this reason, you must always observe road and traffic rules and regulations during your journey. Road and traffic rules and regulations always have priority over multimedia system driving recommendations.

Navigation announcements are intended to direct you while driving without diverting your attention from the road and driving.

Please always use this feature instead of consulting the map display for directions. Looking at the icons or map display can distract you from traffic conditions and driving, and increase the risk of an accident.

This equipment complies with FCC radiation exposure limits set forth for uncontrolled equipment and meets the FCC radio frequency (RF) Exposure Guidelines in Supplement C to OET65.

This equipment has very low levels of RF energy that is deemed to comply without maximum permissive exposure evaluation (MPE). However, it is recommended to install it at a distance of at least 8 inches (approx. 20 cm) between the radiation source and a person's body (not including limbs such as hands, wrists, feet and legs).

### WARNING

Modifications to electronic components, their software as well as wiring can impair their function and/or the function of other networked components. In particular, systems relevant to safety could also be affected. As a result, these may no longer function as intended and/or jeopardize the operating safety of the vehicle. There is an increased risk of an accident and injury.

Never tamper with the wiring as well as electronic components or their software. You should have all work to electrical and electronic equipment carried out at a qualified specialist workshop.

## Function restrictions

For safety reasons, some functions are restricted or unavailable while the vehicle is in motion. You will notice this, for example, because either you will not be able to select certain menu items or a message will appear to this effect.



## Operating system

### Overview

#### General notes

**!** Do not use the space in front of the display for storage. Objects placed here could damage the display or impair its function. Avoid any direct contact with the display surface. Pressure on the display surface may result in impairments to the display, which could be irreversible.

Wearing polarized sunglasses may impair your ability to read the display.

The display has an automatic temperature-controlled switch-off feature. The brightness is automatically reduced if the temperature is too high. The display may temporarily switch off completely.

#### Cleaning instructions

**!** Do not touch the display. The display has a very sensitive high-gloss surface; there is a risk of scratching. If you have to clean the screen, however, use a mild cleaning agent and a soft, lint-free cloth.

The display must be switched off and have cooled down before you start cleaning. Do not apply pressure to the display surface when cleaning it, as this could cause irreversible damage to the display.

#### Switching the multimedia system on/off

► Press the  control knob.



#### Adjusting the volume

► Turn the  control knob.

The volume is adjusted:

- for the currently selected media source
- during traffic or navigation announcements
- in hands-free mode during an active call

#### Switching the sound on or off

► Press the  button on the control panel. If the audio output is switched off, the status line will show the  symbol. If you

switch the media source or set the volume, the sound is automatically switched on.

**i** Navigation announcements will be heard even if the sound is muted.

#### Functions

The multimedia system has the following functions:





- Radio mode
- Media mode with media search
- Sound systems
- Navigation system
- Communication functions
- SIRIUS Weather
- Vehicle functions with system settings
- Favorites functions

#### Controller

The controller in the center console lets you:

- select menu items on the display
- enter characters
- select a destination on the map
- save entries

The controller can be:

- turned 
- slid left or right 
- slid forwards or back 
- slid diagonally 
- pressed briefly or pressed and held 

#### Back button

You can use the  button to exit a menu or to call up the main menu of the current operating mode.

► **To exit the menu:** briefly press the  button.

The multimedia system changes to the next higher menu level in the current operating mode.

► **To call up the main menu:** press the  button for longer than two seconds.



The multimedia system changes to the main menu of the current operating mode.

## Favorites button

You can assign predefined functions using the  favorites button and call them up by pressing the button (▷ page 245).



### Favorites

## Calling up and exiting favorites

- ▶ **To call up:** press the  button on the controller.
- ▶ Select a favorite, e.g. [Vehicle](#).  
The favorites are displayed.
- ▶ **To exit:** press the  button again.

## Adding favorites

### Adding predefined favorites

- ▶ Press the  button.
- ▶ Slide  the controller.
- ▶ Select [Reassign](#).  
The categories are displayed.
- ▶ Select a category.  
The favorites are displayed.
- ▶ Select a favorite.
- ▶ To add the favorite to the desired position, turn and press the controller.  
If a favorite has already been added at this position, it will be overwritten.

### Adding your own favorites

You can add climate control as a favorite, for example.

- ▶ Select [Vehicle](#) → [Vehicle Settings](#).
- ▶ Press and hold the  button until the favorites are displayed.
- ▶ Add a favorite to the desired position.  
If a favorite has already been added at this position, it will be overwritten.

### Navigation mode

## Important safety notes

### WARNING

If you operate information systems and communication equipment integrated in the vehicle when driving, you may be distracted

from the traffic situation. You could also lose control of the vehicle. There is a risk of an accident.

Only operate this equipment when the traffic situation permits. If you are not sure that this is possible, park the vehicle paying attention to traffic conditions and operate the equipment when the vehicle is stationary.

You must observe the legal requirements for the country in which you are currently driving when operating the navigation system.

## General notes

Among other things, correct functioning of the navigation system depends on GPS reception. In certain situations, GPS reception may be impaired, there may be interference or there may be no reception at all, e.g. in tunnels or parking garages.

Further information can be found in the Digital Operator's Manual.

## Selecting a route type and route options

Multimedia system:

- ▶ Select [Navi](#) → [Navigation](#).  
The map shows the vehicle's current position.
- ▶ Slide  the controller.
- ▶ Select [Options](#) → [Route Settings](#).

Notes for route types:

- [Eco Route](#)
- [Dynamic Traffic Route](#)  
Traffic reports on the route for the route guidance are taken into account (not available in all countries).
- [Dynamic TRF. Route After Request](#)  
You can decide whether or not current traffic reports should be included in the route calculation (not available in all countries).
- [Calculate Alternative Routes](#)  
Different routes are being calculated. In order to do so, instead of [Start](#), select the menu item [Continue](#).

- ▶ **To avoid/use route options:** select **Avoid Options**.

- ▶ Select a route option.

Notes for route options:

- **Use Toll Roads**

The route calculation includes roads which require you to pay a usage fee (toll).

- **Number of Occupants in the Vehicle:** (only available in the USA)

Prerequisite: your vehicle meets the access conditions for carpool lanes.

Carpool lanes will be included if the carpool lanes option is activated.

## Entering an address

Multimedia system:

- ▶ Select **Navi** → **Navigation**.

The map shows the vehicle's current position.

- ▶ Slide  the controller.

- ▶ Select **Destination** → **Address Entry**.

Enter an address, e.g. as follows:

- city or ZIP code, street, house number
- state/province, city or ZIP code
- city or ZIP code, center
- street, city or ZIP code, intersection

- ▶ Select **City**.

The city in which the vehicle is currently located (current vehicle position) is at the top. Below this, you will see locations for which route guidance has already been carried out.

- ▶ Enter the city.

The  symbol: the location is contained on the digital map multiple times.

- ▶ **To switch to the list:** slide  the controller.

- ▶ Select the location.

If available, the ZIP code is shown. If there are different ZIP codes available for the location, the corresponding digits are displayed with an **X**.

- ▶ Enter the street and house number. The address is in the menu.

### Further options for destination entry:

- search for a keyword

The keyword search finds destinations using fragments of words.

- select the last destination
- select a contact
- select a POI

You can search for a POI by location, name or telephone number.

- select destination on the map
- enter intermediate destination

You can map the route to the destination yourself with up to four intermediate destinations.

- select destinations from Mercedes-Benz Apps
- select geo-coordinates

## Calculating the route

Prerequisite: the address has been entered and is in the menu.

- ▶ Select **Start** or **Continue**.

The route is calculated with the selected route type and the selected route options.

If route guidance has already been activated, a prompt will appear asking whether you wish to end the current route guidance.

- ▶ Select **Cancel Active Route Guidance** or **Set as Intermediate Destination**.

**Cancel Active Route Guidance** cancels the current route guidance and starts route calculation to the new destination.

**Set as Intermediate Destination** adds the new destination in addition to the existing destination and opens the intermediate destinations list.

## Connecting a mobile phone (COMAND)

### Requirements

For telephony via the Bluetooth® interface, you require a Bluetooth®-capable mobile phone. The mobile phone must support Hands-Free Profile 1.0 or above.

Multimedia system:

- ▶ Select **Vehicle** → **System Settings** → **Activate Bluetooth**.
- ▶ Activate Bluetooth® .

Mobile phone:

- ▶ Activate Bluetooth® and, if necessary, Bluetooth® visibility for other devices (see the manufacturer's operating instructions).

The Bluetooth® device names for all of one manufacturer's products might be identical. To make it possible to clearly identify your mobile phone, change the device name (see the manufacturer's operating instructions).

If the mobile phone supports the PBAP (Phone Book Access Profile) and MAP (Message Access Profile) Bluetooth® profiles, the following information will be transmitted after you connect:

- Phone book
- Call lists
- Text messages and e-mail

**i** Further information on suitable mobile phones can be found at: <http://www.mercedes-benz.com/connect>

**i** In the USA, you can get in touch with the Mercedes-Benz Customer Assistance Center on 1-800-FOR-MERCEdes (1-800-367-6372).

In Canada, you can get in touch with the Customer Relations Center on 1-800-387-0100.

### Searching for and authorizing (connecting) a mobile phone

Before using your mobile phone with the multimedia system for the first time, you will need to search for the phone and then authorize (connect) it. Depending on the mobile phone, authorization either takes place by means of Secure Simple Pairing or by entering a passkey. The multimedia system automatically makes the procedure that is relevant for your mobile phone available. The mobile phone is always connected automatically after authorization. Further information on using a mobile phone with the multimedia system (see the Digital Operator's Manual).

If the multimedia system does not detect your mobile phone, this may be due to particular security settings on your mobile phone (see the manufacturer's operating instructions).

Only one mobile phone can be connected to the multimedia system at any one time.



#### Searching for a mobile phone

Multimedia system:

- ▶ Select **Tel/**  → **Conn. Device** → **Search for Phones** → **Start Search**.

The available mobile phones are displayed.

#### Symbols in the device list

Symbol	Explanation
	New mobile phone found, not yet authorized.
	Mobile phone is authorized, but is not connected.

#### Connecting a mobile phone

Authorization using Secure Simple Pairing:

- ▶ Select mobile phone.  
A code is displayed in the multimedia system and on the mobile phone.
- ▶ **If codes match:** select **Yes** on the multimedia system.
- ▶ Confirm code on the mobile phone. Depending on the mobile phone used, confirm the connection to the multimedia system and for the PBAP and MAP Bluetooth® profiles. The prompt to confirm may take up to two minutes to be displayed (see the manufacturer's operating instructions).
- ▶ **If the codes are different:** select **No** on the multimedia system.  
The process is canceled.  
Repeat authorization.

Authorization by entering a passkey (passcode):

- ▶ Select the Bluetooth® name of the mobile phone.  
The input menu for the passkey is displayed.
- ▶ Choose a one to sixteen-digit number combination as a passkey.
- ▶ Enter the passkey on the multimedia system.
- ▶ Press  to confirm.
- ▶ Enter and confirm the passkey on the mobile phone. Depending on the mobile phone used, confirm the connection to the multimedia system and for the PBAP and MAP Bluetooth® profiles. The prompt to confirm may take up to two minutes to be

displayed (see the manufacturer's operating instructions).

## Media mode

### General notes

If you wish to play external media sources, the appropriate media mode must already be turned on. Further information on media mode (see the Digital Operator's Manual).

The following external media sources can be used:

- Apple® devices (e.g. iPhone®)
- USB devices (e.g. USB stick, MP3 player) (▷ page 248)
- CD
- DVD (COMAND)
- SD cards
- Via devices connected by Bluetooth®

**i** Information on single CD/DVD drive or DVD changer (see the Digital Operator's Manual).

### Selecting using the device list

Multimedia system:

- ▶ Select **Media** → **Devices**.  
The available media sources will be shown.  
The • dot indicates the current setting.
- ▶ Select the media source.  
Playable files are played.

### Inserting/removing an SD card

#### Important safety notes

##### WARNING

SD cards are small parts. They can be swallowed and cause choking. This poses an increased risk of injury or even fatal injury.

Keep the SD card out of the reach of children. If a SD card is swallowed, seek medical attention immediately.

**!** If the SD card is no longer in use, you should take it out and remove it from the vehicle. High temperatures can damage the card.

### Inserting an SD card

The SD card slot is located on the control panel.

- ▶ Insert the SD card into the SD card slot until the SD card engages. The side with the contacts must face down.

### Removing an SD card

- ▶ Press the SD card.  
The SD card is ejected.
- ▶ Remove the SD card.

### Connecting USB devices

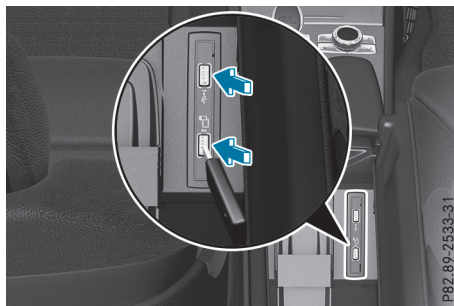

- ▶ Connect the USB device to the USB port.  
There are two USB ports in the stowage space under the armrest.
- ▶ Select the media source (▷ page 248).

## Stowage areas

### Stowage spaces

#### Important safety notes

##### WARNING

If objects in the passenger compartment are stowed incorrectly, they can slide or be thrown around and hit vehicle occupants. In addition, cup holders, open stowage spaces and mobile phone brackets cannot always retain all objects they contain. There is a risk of injury, particularly in the event of sudden braking or a sudden change in direction.

- Always stow objects so that they cannot be thrown around in such situations.
- Always make sure that objects do not protrude from stowage spaces, parcel nets or stowage nets.
- Close the lockable stowage spaces before starting a journey.
- Always stow and secure heavy, hard, pointed, sharp-edged, fragile or bulky objects in the trunk.

#### Glove compartment

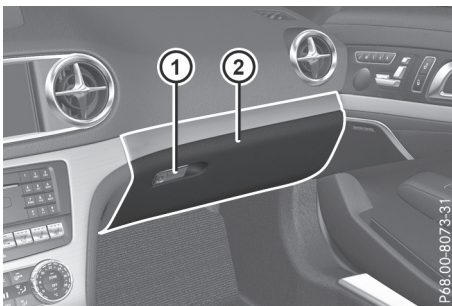

- ▶ **To open:** pull handle ① and open glove box flap ②.
- ▶ **To close:** fold glove box flap ② up until it engages.

In the glove box, there are a coin holder, a map holder and a pen holder.

- i** The glove box can be ventilated (> page 123).

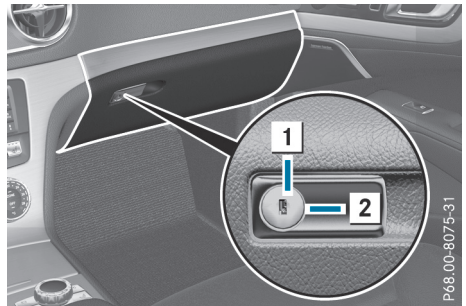

The glove box can be locked and unlocked using the mechanical key.

- ▶ **To lock:** insert the mechanical key into the lock and turn it to position ②.
- ▶ **To unlock:** insert the mechanical key into the lock and turn it to position ①.

#### Stowage compartment/telephone compartment under the armrest

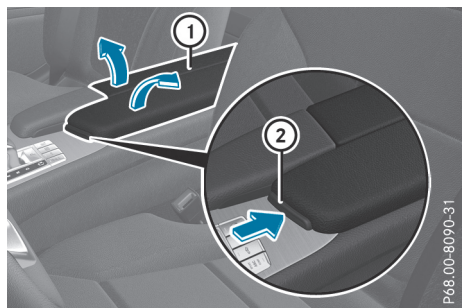

- ▶ **To open:** press button ①. Armrest ② folds out.

In the stowage compartment, there is a stowage tray.

- i** Depending on the vehicle equipment, a USB port and a Media Interface is installed in the stowage compartment. A Media Interface is a universal interface for mobile audio equipment, e.g. for an iPod® or MP3 Player.



## Eyeglasses compartment



- **To open:** press marking ①.  
Eyeglasses compartment ② opens.

Make sure that the eyeglasses compartment is always closed while the vehicle is in motion.

## Stowage compartment in the center console

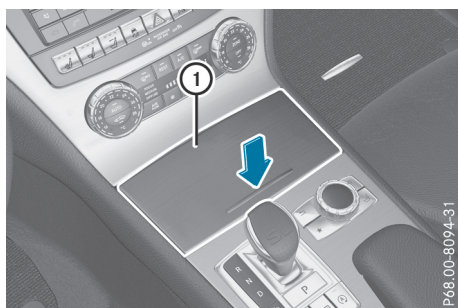

- **To open:** press the trim element on cover ①.
- **To remove the rubber mat:** grasp the tabs on the rubber mat and pull up to remove.
- **To insert the rubber mat:** press the rubber mat into the housing.
- **To close:** swing cover ① downwards until it engages.

You can remove the rubber mat from the stowage compartment to clean it. Clean with clear, lukewarm water only.

Depending on the vehicle's equipment, there is a cup holder and an ashtray in the center console stowage compartment.

## Umbrella holder

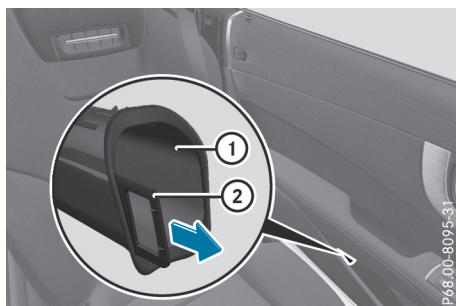

Example: vehicle side, left

There are umbrella holders in the door stowage compartments on both sides of the vehicle. One compact umbrella can be stowed per side.

- **To remove:** grab strap ② and pull umbrella holder ① out of the stowage compartment in the direction of the arrow.
- **To insert:** push umbrella holder ① in the opposite direction to the arrow, into the stowage compartment until it engages.

You can remove the umbrella holder to clean it. Clean with clear, lukewarm water only.

## Stowage compartment in the rear center console

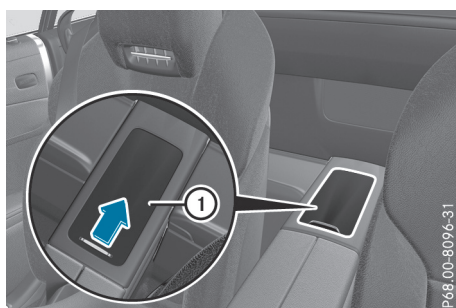

- **To open:** slide cover ① in the direction of the arrow.

On vehicles equipped with a bottle holder, the bottle holder is located in the stowage compartment (► page 253).



## Stowage compartment in the rear passenger compartment

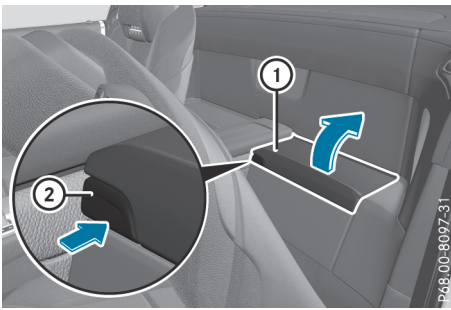

Only the left side of the vehicle features a rear stowage compartment.

- ▶ Open the seat belt guide and remove the seat belt (▷ page 99).
- ▶ Move the left-hand front seat forward (▷ page 100) and fold the seat backrest forward.
- ▶ **To open:** press release button (2). Cover (1) folds up.
- ▶ **To close:** fold down cover (1) and let it engage.
- ▶ Fold back the seat backrest of the left-hand front seat and move the seat back (▷ page 100).
- ▶ Insert the seat belt back into the seat belt guide.

## Stowage net

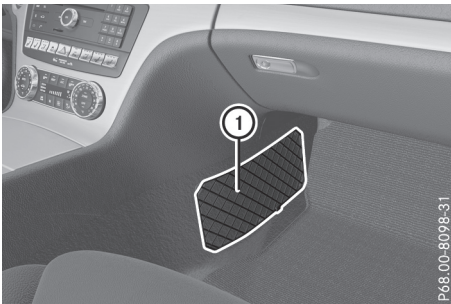

There is a stowage net (1) in the front-passenger footwell.

## Loading aid in the trunk

### Raising/lowering the roof

#### WARNING

Body parts can become trapped when the roof is being raised or lowered. There is a risk of injury.

When raising or lowering the roof, make sure that no parts of the body are in the vicinity of moving parts. Press the switch again if someone becomes trapped.

- ❗ Only close the trunk once the roof is lowered completely. Otherwise, you could damage the roof.

If you close the trunk lid before the roof is lowered completely, the loading aid switch lights up and a warning tone sounds.

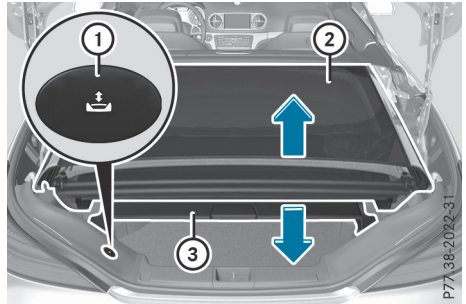

To make it easier to load your luggage, you can raise the stowed roof after you have opened the trunk lid.

You can only raise roof (2) when the trunk lid is fully open.

- ▶ **To raise the roof:** press switch (1). Roof (2) is raised slightly and trunk partition (3) moves to the open position. Switch (1) lights up brightly.
- ▶ **To lower the roof:** press switch (1). The trunk partition moves to the closed position and roof (2) lowers slightly. Switch (1) lights up dimly.

**Vehicles with trunk lid remote closing feature:** when the trunk lid is opened, the loading aid raises automatically. It lowers automatically when the trunk lid is closed.

**Vehicles with KEYLESS-GO and HANDS-FREE ACCESS:** when the trunk lid is

opened, the loading aid rises automatically. When the roof is closed, the trunk partition remains in the open position. The trunk par-

tion moves to the closed position automatically when the roof is lowered.

## Problems with the loading aid

Problem	Possible causes/consequences and ► Solutions
It is no longer possible to lower the stowed roof in the trunk using the loading aid.	You cannot close the trunk any more. ► Call a qualified specialist workshop.

## Stowage well under the trunk floor

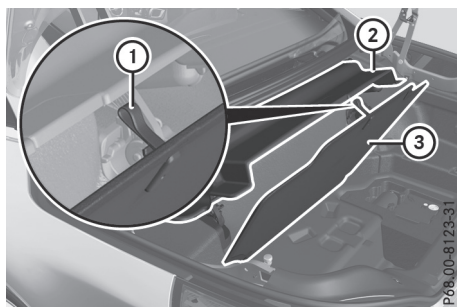

- **To open:** open trunk partition ② (► page 93).
- Swing trunk floor ③ up using loop ①.

The TIREFIT kit, tire-change tool kit, etc. is located in the stowage compartment.

- Always stow objects so that they cannot be thrown around in such situations.
- Always make sure that objects do not protrude from stowage spaces, parcel nets or stowage nets.
- Close the lockable stowage spaces before starting a journey.
- Always stow and secure heavy, hard, pointed, sharp-edged, fragile or bulky objects in the trunk.

### **WARNING**

The heating elements of the cup holder can become very hot. You could burn yourself on them.

There is a risk of injury.

Do not touch the hot heating elements of the cup holder. Always make sure that children cannot access the hot heating elements of the cup holder. Never leave children unsupervised in the vehicle.

## Features

### Cup holder

## Important safety notes

### **WARNING**

If objects in the passenger compartment are stowed incorrectly, they can slide or be thrown around and hit vehicle occupants. In addition, cup holders, open stowage spaces and mobile phone brackets cannot always retain all objects they contain. There is a risk of injury, particularly in the event of sudden braking or a sudden change in direction.

- ❗ Only use the cup holders for containers of the right size and which have lids. The drinks could otherwise spill.

- ❗ Do not expose drinks bottles in the cup holder in the center console to continuous, strong and direct sunlight. The passenger compartment in the area of the center console can otherwise be damaged by the concentrated and reflected sunlight.

### Cup holder in the center console

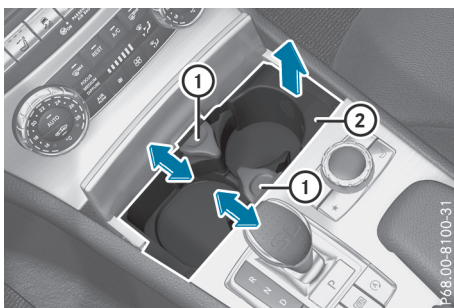

- ▶ **To open:** open the stowage compartment (▷ page 250).
- ▶ **To remove the insert:** slide catches ① inwards in the direction of the arrow.
- ▶ Remove the cup holder insert upwards.
- ▶ **To re-install the insert:** place the insert in the stowage space.
- ▶ Slide catches ① outwards in the direction of the arrow until they engage.

You can remove the cup holder's rubber mat for cleaning. Clean with clear, lukewarm water only.

Reducer ② can be removed. Large and small containers can then be placed in the cup holder.

- ▶ **To remove:** grasp reducer ② and pull upwards in the direction of the arrow.
- ▶ **To insert:** insert reducer ② into the cup holder in the opposite direction of the arrow and press it down firmly.

### Bottle holder

Observe the "Important safety notes" in the "Stowage compartments" section (▷ page 249).

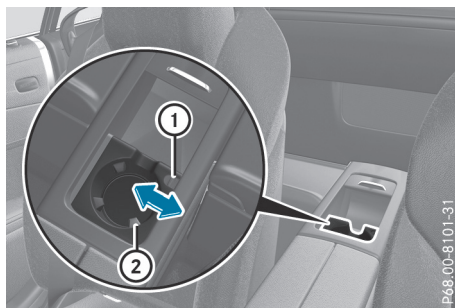

- ▶ **To open:** open the stowage compartment (▷ page 250).
- ▶ **To remove the insert:** slide catches ① inwards in the direction of the arrow.
- ▶ Lift bottle holder insert ② up and remove.
- ▶ **To re-install the insert:** place insert ② in the stowage compartment.
- ▶ Slide catches ① outwards in the direction of the arrow until they engage.

The bottle holder does not secure the bottles; it merely prevents them from tipping over.

### Sun visors

#### Overview

#### ⚠ WARNING

If the mirror cover of the vanity mirror is folded up when the vehicle is in motion, you could be blinded by incident light. There is a risk of an accident.

Always keep the mirror cover folded down while driving.

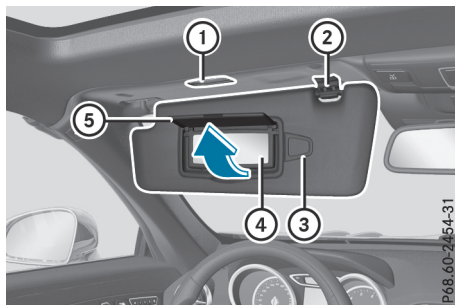

- ① Mirror light
- ② Bracket

- ③ Retaining strip, e.g. for a parking lot ticket
- ④ Vanity mirror
- ⑤ Mirror cover

### Ashtray

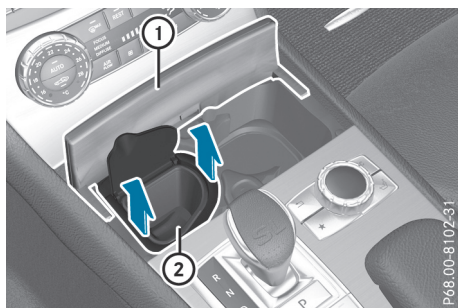

- ▶ **To open:** open stowage compartment ① (▷ page 250).
  - ▶ **To remove the insert:** pull insert ② up in the direction of the arrow, out of the cup holder.
  - ▶ **To re-install the insert:** push insert ② on the left-hand side into the cup holder.
- i** Only re-install insert ② on the left-hand side of the cup holder.

### Cigarette lighter

#### WARNING

You can burn yourself if you touch the hot heating element or the socket of the cigarette lighter.

In addition, flammable materials can ignite if:

- the hot cigarette lighter falls
- a child holds the hot cigarette lighter to objects, for example

There is a risk of fire and injury.

Always hold the cigarette lighter by the knob. Always make sure that the cigarette lighter is out of reach of children. Never leave children unsupervised in the vehicle.

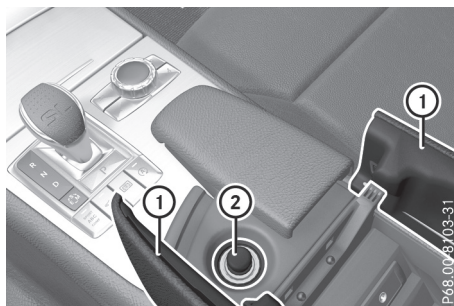

Your attention must always be focused on the traffic conditions. Only use the cigarette lighter when road and traffic conditions permit.

- ▶ Turn the SmartKey to position ② in the ignition lock (▷ page 126).
- ▶ **To open:** open stowage compartment ① under the armrest (▷ page 249).
- ▶ Press in cigarette lighter ②. Cigarette lighter ② will pop out automatically when the heating element is red-hot.

### 12 V sockets

#### General notes

- ▶ Turn the SmartKey to position ① in the ignition lock (▷ page 126).

The sockets can be used for accessories with a maximum draw of 180 W (15 A). Accessories include such items as chargers for mobile phones.

If you use the sockets for long periods when the engine is switched off, the battery may discharge.

- i** An emergency cut-out ensures that the on-board voltage does not drop too low. If the on-board voltage is too low, the power to the sockets is automatically cut. This ensures that there is sufficient power to start the engine.

### Socket in the front-passenger footwell

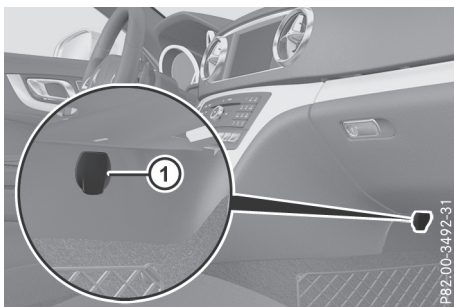

► Lift up the cover of socket ①.

### Socket in the trunk

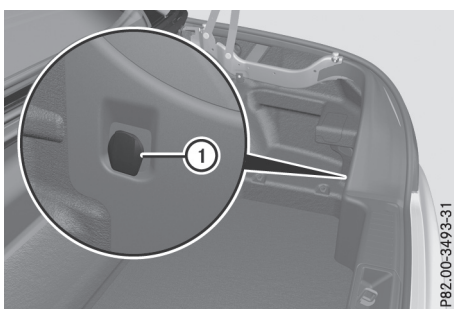

► Lift up the cover of socket ①.

## Mercedes me connect

### General notes

A license agreement must be in place in order to activate the Mercedes me connect service. Make sure that your system is activated and operational. To register, press the  MB Info call button. If any of the steps mentioned are not carried out, the system may not be activated.

If you have questions about the activation, contact one of the following telephone hot-lines:

- **USA:** Mercedes-Benz Customer Assistance Center at 1-800-FOR-MERcedes (1-800-367-6372) or 1-866-990-9007
- **Canada:** Customer Service at 1-888-923-8367

Shortly after successfully registering with the service, a user ID and password will be sent to you by post.

USA only: you can use this password to log onto the Mercedes me connect area under "Owners Online" at <http://www.mbusa.com>.

The system is available if:

- it has been activated and is operational
  - the corresponding mobile phone network is available for transmitting data to the Customer Center
  - a service subscription is available
  - the starter battery is sufficiently charged
- i** Determining the location of the vehicle on a map is only possible if:
- GPS reception is available
  - the vehicle position can be forwarded to the Customer Assistance Center

### The Mercedes me connect system

To adjust the volume during a call, proceed as follows:

► Press the  or  button on the multi-function steering wheel.

or

► Use the volume controller of COMAND.

The system offers various services, e.g.:



- Automatic and manual emergency call
- Roadside Assistance call
- MB Info call

USA only: you can find information and a description of all available features under "Owners Online" at <http://www.mbusa.com>.



### System self-test

After you have switched on the ignition, the system carries out a self-diagnosis.

A malfunction in the system has been detected if one of the following occurs:

- The indicator lamp in the SOS button does not come on during the system self-test.
- The indicator lamp in the  Roadside Assistance button does not light up during self-diagnosis of the system.
- The indicator lamp in the  MB Info call button does not light up during self-diagnosis of the system.



- The indicator lamp in one or more of the following buttons continues to light up red after the system self-diagnosis:
  - SOS button
  -  Roadside Assistance call button
  -  MB Info call button
- After the system self-diagnosis, the **Inoperative** or **Service Not Activated** message appears in the multifunction display.

If a malfunction is indicated as outlined above, the system may not operate as expected. In the event of an emergency, help will have to be summoned by other means.

Have the system checked at the nearest Mercedes-Benz Service Center or contact the following service hotlines:

- **USA:** Mercedes-Benz Customer Assistance Center at 1-800-FOR-MERCEdes (1-800-367-6372) or 1-866-990-9007
- **Canada:** Customer Service at 1-888-923-8367

## Emergency call

### Important safety notes

#### WARNING

It can be dangerous to remain in the vehicle, even if you have pressed the SOS button in an emergency if:

- you see smoke inside or outside of the vehicle, e.g. if there is a fire after an accident
- the vehicle is on a dangerous section of road
- the vehicle is not visible or cannot easily be seen by other road users, particularly when dark or in poor visibility conditions

There is a risk of an accident and injury.

Leave the vehicle immediately in this or similar situations as soon as it is safe to do so. Move to a safe location along with other vehicle occupants. In such situations, secure the vehicle in accordance with national regulations, e.g. with a warning triangle.

A license agreement must be in place in order to activate the Mercedes me connect service. Make sure that your system is activated and

operational. To register, press the  MB Info call button. If any of the steps mentioned are not carried out, the system may not be activated.

If you have questions about the activation, contact one of the following telephone hotlines:

- **USA:** Mercedes-Benz Customer Assistance Center at 1-800-FOR-MERCEdes (1-800-367-6372) or 1-866-990-9007
- **Canada:** Customer Service at 1-888-923-8367

### General notes

An emergency call is dialed automatically if an air bag or Emergency Tensioning Device is triggered.

 You cannot end an automatically triggered emergency call yourself.

An emergency call can also be initiated manually.

As soon as the emergency call has been initiated, the indicator lamp in the SOS button flashes. The multifunction display shows the **Connecting Call** message.

The audio output is muted.

Once the connection has been made, the **Call Connected** message appears in the multifunction display.

All important information on the emergency is transmitted, for example:

- Current location of the vehicle (as determined by the GPS system)
- Vehicle identification number
- Information on the severity of the accident

Shortly after the emergency call has been initiated, a voice connection is automatically established between the Customer Assistance Center and the vehicle occupants.

- If the vehicle occupants are responsive, the Mercedes-Benz Customer Assistance Center attempts to get more information on the emergency.
- If there is no response from the vehicle occupants, an ambulance is immediately sent to the vehicle.

If no voice connection can be established to the Mercedes-Benz Customer Assistance Center, the system has been unable to initiate an emergency call.

This can occur, for example, if the relevant mobile phone network is not available. The indicator lamp in the SOS button flashes continuously.

The **Call Failed** message appears in the multifunction display and must be confirmed. In this case, summon assistance by other means.

### Making an emergency call

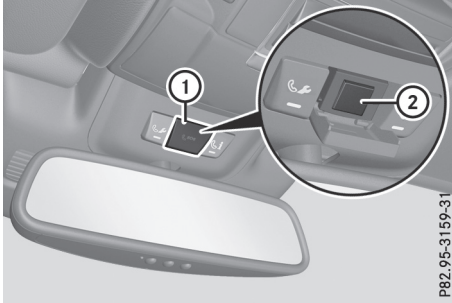

- ▶ **To initiate an emergency call manually:** press cover ① briefly to open.
- ▶ Press SOS button ② briefly. The indicator lamp in SOS button ② flashes until the emergency call is concluded.
- ▶ Wait for a voice connection to the Mercedes-Benz Customer Assistance Center.
- ▶ After the emergency call, close cover ①.

**i** If the mobile phone network is unavailable, Mercedes me connect is not able to make an emergency call. If you leave the vehicle immediately after pressing the SOS button, you do not know if Mercedes me connect has successfully made the emergency call. In this case, always summon assistance by other means.

### Breakdown assistance call button



- ▶ Press Roadside Assistance button ①. This initiates a call to the Mercedes-Benz Customer Assistance Center. The indicator lamp in Roadside Assistance button ① flashes while the call is active. The multifunction display shows the **Connecting Call** message. The audio output is muted.

If a connection can be made, the **Call Connected** message appears in the multifunction display.

If a mobile phone network and GPS reception are available, the system transfers data to the Mercedes-Benz Customer Assistance Center, for example:

- Current location of the vehicle
- Vehicle identification number

**i** The COMAND display indicates that a call is active. During the call, you can change to the navigation menu by pressing the NAVI button on COMAND, for example. Voice output is not available.

A voice connection is established between the Mercedes-Benz Customer Assistance Center and the vehicle occupants.

From the remote malfunction diagnosis, the Mercedes-Benz Customer Assistance Center can ascertain the nature of the problem (▷ page 259).

The Mercedes-Benz Customer Assistance Center either sends a qualified Mercedes-Benz technician or makes arrangements for your vehicle to be transported to the nearest Mercedes-Benz Service Center.

You may be charged for services such as repair work and/or towing.



You can obtain further information from your Mercedes me connect manual.

**i** The system has not been able to initiate a Roadside Assistance call, if:

- the indicator lamp for Roadside Assistance call button ① is flashing continuously.
- no voice connection to the Mercedes-Benz Customer Assistance Center has been established.

This can occur if the relevant mobile phone network is not available, for example.

The **Call Failed** message appears in the multifunction display.

▶ **To end a call:** press the  button on the multifunction steering wheel.

or

▶ Press the corresponding button for ending a phone call on COMAND.

### MB Info call button



- ▶ Press MB Info call button ①. This initiates a call to the Mercedes-Benz Customer Assistance Center. The indicator lamp in MB Info call button ① flashes while the connection is being made. The multifunction display shows the **Connecting Call** message. The audio system is muted.

If a connection can be made, the **Call Connected** message appears in the multifunction display.

If a mobile phone network and GPS reception are available, the system transfers data to the Mercedes-Benz Customer Assistance Center, for example:

- Current location of the vehicle
- Vehicle identification number

**i** The COMAND display indicates that a call is active. During the call, you can change to the navigation menu by pressing the NAVI button on COMAND, for example.

Voice output is not available.

A voice connection is established between the Mercedes-Benz Customer Assistance Center and the vehicle occupants.

You receive information about operating your vehicle, about the nearest Mercedes-Benz Service Center and about other products and services from Mercedes-Benz.

USA only: you can find further information on the Mercedes me connect system under "Owners Online" at <http://www.mbusa.com>.

**i** The system has not been able to initiate an MB Info call, if:

- the indicator lamp in MB Info call button ① is flashing continuously.
- no voice connection to the Mercedes-Benz Customer Assistance Center was established.

This can occur if the relevant mobile phone network is not available, for example.

The **Call Failed** message appears in the multifunction display.

▶ **To end a call:** press the  button on the multifunction steering wheel.

or

▶ Press the corresponding button for ending a phone call on COMAND.

### Call priority

When service calls are active, e.g. Roadside Assistance or MB Info calls, an emergency call can still be initiated. In this case, an emergency call will take priority and override all other active calls.

The indicator lamp of the respective button flashes until the call is ended.

An emergency call can only be terminated by the Mercedes-Benz Customer Assistance Center.

All other calls can be ended by pressing:

- the  button on the multifunction steering wheel
- or the corresponding COMAND button for ending a telephone call

**i** When a call is initiated, the audio system is muted. The mobile phone is no longer connected to COMAND. However, if you want to use your mobile phone, do so only when the vehicle is stationary and in a safe location.

## Vehicle Health Check

With the Vehicle Health Check, the Customer Assistance Center can provide improved support for problems with your vehicle. During an existing call, vehicle data is transferred to the Customer Assistance Center. The customer service representative can use the received data to decide what kind of assistance is required. You are then, for example, guided to the nearest Mercedes-Benz Service Center or a recovery vehicle is called.

If vehicle data needs to be transferred during an MB Info call or a Roadside Assistance call, this is initiated by the Customer Assistance Center. You will see the **Roadside Assistance Connected** message in the COMAND display. If the Vehicle Health Check can be started, the **Request for vehicle diagnosis received. Start vehicle diagnosis?** message appears in the display.

- ▶ Confirm the message with **Yes**.
- ▶ When the **Vehicle Diagnosis: Please start ignition.** message appears, turn the SmartKey to position **2** in the ignition lock (▷ page 126).
- ▶ When the **Please follow the instructions received by phone and move your vehicle to a safe position** message appears, follow the customer service representative's instructions. The message in the display disappears. If you select **Cancel** the Vehicle Health Check is canceled completely. The vehicle operating state check begins. You will see the **Vehicle diagnosis activated.** message.

When the check is completed, the **Send vehicle diagnostics data (Voice connection may be interrupted during**

**data transfer)** message appears. The vehicle data can now be sent to the Customer Assistance Center.

- ▶ Press **OK** to confirm the message. The voice connection with the Customer Assistance Center is terminated. You will see the **Vehicle Diagnosis: Transferring data...** message. The vehicle data is sent to the Customer Assistance Center.

Depending on what the customer service representative agreed with you, the voice connection is re-established after the transfer is complete. If necessary, you will be contacted at a later time by another means, e.g. by e-mail or phone.

Another function of the Vehicle Health Check is the transfer of service data to the Customer Assistance Center. If a service is overdue, the COMAND display shows a message about various special offers at your workshop.

USA only: this information can also be called up under "Owners Online" at <http://www.mbusa.com>.

Information on the data stored in the vehicle (▷ page 29).

Information on Roadside Assistance (▷ page 26).

## Garage door opener

### General notes

The HomeLink® garage door opener integrated in the rear-view mirror allows you to operate up to three different door and gate systems. Use the integrated garage door opener only on garage doors that:

- have safety stop and reverse features and
- meet current U.S. federal safety standards

Once programmed, the integrated garage door opener in the rear-view mirror will assume the function of the garage door system's remote control. Please also read the operating instructions for the garage door system.

When programming a garage door opener, park the vehicle outside the garage. Do not run the engine while programming.

Certain garage door drives are incompatible with the integrated garage door opener. If you have difficulty programming the integrated

garage door opener, contact an authorized Mercedes-Benz Center.

Alternatively, you can call the following telephone assistance services:

- **USA:** Mercedes-Benz Customer Assistance Center at 1-800-FOR-MERCEdes
- **Canada:** Customer Service at 1-800-387-0100
- HomeLink® hotline 1-800-355-3515 (free of charge)

More information on HomeLink® and/or compatible products is also available online at <http://www.homelink.com>.

Notes on the declaration of conformity (▷ page 27).

USA: FCC ID: CB2HMIHL4

Canada: IC: 279B-HMIHL4

## Important safety notes

### ⚠ WARNING

When you operate or program the door with the integrated garage door opener, persons in the range of movement of the door may become trapped or be struck by the door. There is a risk of injury.

When using the integrated garage door opener, always make sure that nobody is within the range of movement of the door.

### ⚠ DANGER

Combustion engines emit poisonous exhaust gases such as carbon monoxide. Inhaling these exhaust gases is hazardous to health and can result in poisoning. There is a risk of fatal injury. Therefore, never leave the engine running an enclosed space without adequate ventilation.

## Programming

### Programming the buttons

Pay attention to the "Important safety notes" (▷ page 260).

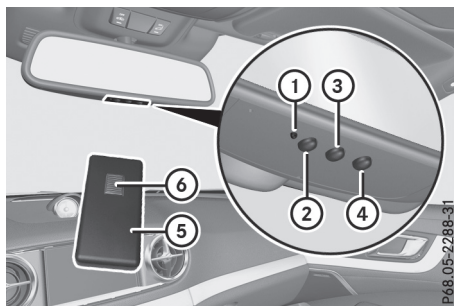

Garage door remote control ⑤ is not included with the integrated garage door opener.

- ▶ Turn the SmartKey to position ② in the ignition lock (▷ page 126).
- ▶ Select one of buttons ② to ④ to use to control the garage door drive.
- ▶ **To start programming mode:** press and hold one of buttons ② to ④ on the integrated garage door opener. The garage door opener is now in programming mode. After a short time, indicator lamp ① lights up yellow. Indicator lamp ① lights up yellow as soon as button ②, ③ or ④ is stored for the first time. If the selected button has already been programmed, indicator lamp ① will only light up yellow after ten seconds have elapsed.
- ▶ Release button ②, ③ or ④. Indicator lamp ① flashes yellow.
- ▶ **To program the remote control:** point garage door remote control ⑤ towards buttons ② to ④ on the rear-view mirror at a distance of 2 to 8 in (5 to 20 cm).
- ▶ Press and hold button ⑥ on remote control ⑤ until indicator lamp ① lights up green. When indicator lamp ① lights up green: programming is finished. When indicator lamp ① flashes green: programming was successful. The next step is to synchronize the rolling code (▷ page 261).
- ▶ Release button ⑥ on remote control ⑤ for the garage door drive system. If indicator lamp ① lights up red: repeat the programming procedure for the corresponding button on the rear-view mirror. When doing so, vary the distance between remote control ⑤ and the rear-view mirror.

The required distance between remote control ⑤ and the integrated garage door opener depends on the garage door drive system. Several attempts might be necessary. You should test every position for at least 25 seconds before trying another position.

### Synchronizing the rolling code

Pay attention to the "Important safety notes" (▷ page 260).

If the garage door system uses a rolling code, you will also have to synchronize the garage door system with the integrated garage door opener in the rear-view mirror. To do this you will need to use the programming button on the door drive control panel. The programming button may be located in different places depending on the manufacturer. It is usually located on the door drive unit on the garage ceiling.

Familiarize yourself with the garage door drive operating instructions, e.g. under "Programming additional remote controls", before carrying out the following steps.

Your vehicle must be within reach of the garage door or gate opener drive. Make sure that neither your vehicle nor any persons/objects are present within the sweep of the door or gate.

- ▶ Turn the SmartKey to position ② in the ignition lock (▷ page 126).
- ▶ Get out of the vehicle.
- ▶ Press the programming button on the door drive unit.  
Usually, you now have 30 seconds to initiate the next step.
- ▶ Get into the vehicle.
- ▶ Press previously programmed button ②, ③ or ④ on the integrated garage door opener repeatedly until the door closes.  
The rolling code synchronization is then complete.

### Notes on programming the remote control

Canadian radio frequency laws require a "break" (or interruption) of the transmission signals after broadcasting for a few seconds. Therefore, these signals may not last long enough for the integrated garage door opener. The signal is not recognized during programming. Comparable with Canadian law, some

U.S. garage door openers also feature a "break".

Proceed as follows:

- if you live in Canada.
  - if you have difficulties programming the garage door opener (regardless of where you live) when following the programming steps.
- ▶ Press and hold one of buttons ② to ④ on the integrated garage door opener.  
After a short time, indicator lamp ① lights up yellow.
  - ▶ Release the button.  
Indicator lamp ① flashes yellow.
  - ▶ Press button ⑥ of garage door remote control ⑤ for two seconds, then release it for two seconds.
  - ▶ Press button ⑥ again for two seconds.
  - ▶ Repeat this sequence on button ⑥ of remote control ⑤ until indicator lamp ① lights up green.  
When indicator lamp ① lights up green: programming is finished.  
When indicator lamp ① flashes green: programming was successful. The next step is to synchronize the rolling code.
  - ▶ Release button ⑥ of remote control ⑤ of the garage door drive.  
When indicator lamp ① lights up red: repeat the programming process for the corresponding button on the rear-view mirror. When doing so, vary the distance between remote control ⑤ and the rear-view mirror.  
The required distance between remote control ⑤ and the integrated garage door opener depends on the garage door drive system. Several attempts might be necessary. You should test every position for at least 25 seconds before trying another position.

### Problems when programming

If you are experiencing problems programming the integrated garage door opener on the rear-view mirror, take note of the following instructions:

- Check the transmitter frequency used by garage door drive remote control ⑤ and whether it is supported. The transmitter frequency can usually be found on the back of remote control ⑤ for the garage door drive.

The integrated garage door opener is compatible with devices that have units which operate in the frequency range of 280 to 433 MHz.

- ▶ Replace the batteries in garage door remote control ⑤. This increases the likelihood that garage door remote control ⑤ will transmit a strong and precise signal to the integrated garage door opener.
- ▶ When programming, hold remote control ⑤ at varying distances and angles from buttons ② to ④ which you are programming. Try various angles at a distance between 2 and 8 inches (5 to 20 cm) or at the same angle but at varying distances.
- ▶ If a further remote control ⑤ is available for the same garage door drive, repeat the same programming steps with this remote control ⑤. Before performing these steps, make sure that new batteries have been installed in garage door drive remote control ⑤.
- ▶ Note that some remote controls only transmit for a limited amount of time (the indicator lamp on the remote control goes out). Press button ⑥ on remote control ⑤ again before transmission ends.
- ▶ Align the antenna cable of the garage door opener unit. This can improve signal reception/transmission.

### Opening/closing the garage door

After it has been programmed, the integrated garage door opener performs the function of the garage door system remote control. Please also read the operating instructions for the garage door system.

- ▶ Turn the SmartKey to position ② in the ignition lock (▷ page 126).
- ▶ Press either button ②, ③ or ④ which you have programmed to operate the garage door.
  - Garage door system with a fixed code: indicator lamp ① lights up green.
  - Garage door system with a rolling code: indicator lamp ① flashes green.
 The transmitter will transmit a signal as long as the button is pressed. The transmission is halted after a maximum of ten seconds and indicator lamp ① lights up yellow.
- ▶ Press button ②, ③ or ④ again if necessary.

### Clearing the memory

Make sure that you clear the memory of the integrated garage door opener before selling the vehicle.

- ▶ Turn the SmartKey to position ② in the ignition lock (▷ page 126).
- ▶ Press and hold buttons ② and ④. The indicator lamp initially lights up yellow and then green.
- ▶ Release buttons ② and ④. The memory of the integrated garage door opener in the rear-view mirror is cleared.

### Compass

#### Calling up the compass

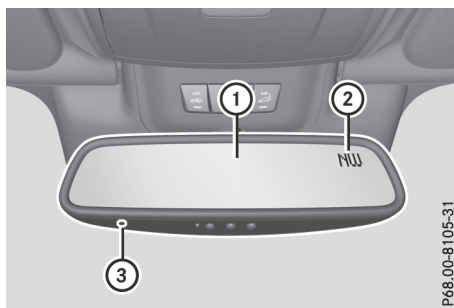

Compass ② displays the compass direction in which the vehicle is currently traveling: **N, NE, E, SE, S, SW, W** or **NW**.

To receive a correct display in rear-view mirror ①, the compass must be calibrated and the magnetic field zone set.

## Setting the compass

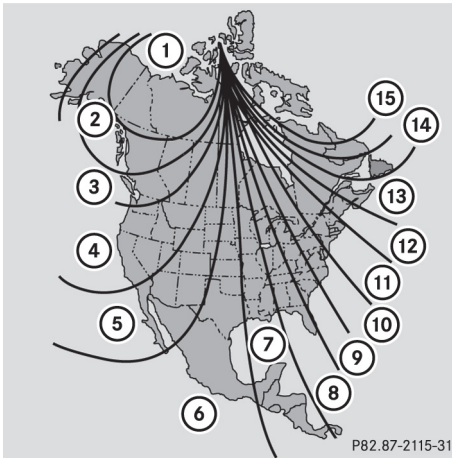

North America zone map

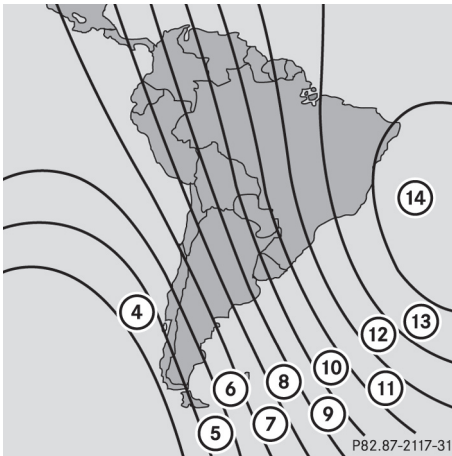

South America zone map

- ▶ Set your location using the zone maps.
- ▶ Push a round pen into opening ③ (▷ page 262) for approximately three seconds. The zone currently selected appears in compass display ② (▷ page 262).
- ▶ **To select the zone:** push a round pen into opening ③ (▷ page 262) until the desired zone is selected. If, after a few seconds, the display in compass display ② (▷ page 262) changes direction, the zone has been selected.

## Calibrating the compass

- ▶ Make sure that there is sufficient space for you to drive in a circle without impeding traffic.
- In order to calibrate the compass correctly, do the following:
- calibrate the compass in the open and not in the vicinity of steel structures or high-voltage transmission lines.
  - switch off electrical consumers such as the climate control, windshield wipers or rear window defroster.
  - close all doors and the trunk lid.
- ▶ Switch on the ignition.
- ▶ Push a round pen into opening ③ (▷ page 262) for approximately six seconds, until symbol C is shown in compass display ② (▷ page 262).
- ▶ Drive your vehicle in a full circle at approximately 3 mph (5 km/h) to 6 mph (10 km/h). When the calibration has successfully been completed, the current direction is shown in compass display ② (▷ page 262).

## Floormats

### ⚠ WARNING

Objects in the driver's footwell may restrict the clearance around the pedals or block a depressed pedal. This jeopardizes the operating and road safety of the vehicle. There is a risk of an accident.

Stow all objects securely in the vehicle so that they do not get into the driver's footwell. When using floormats or carpets, make sure that they are properly secured so that they do not slip or obstruct the pedals. Do not place several floormats or carpets on top of one another.



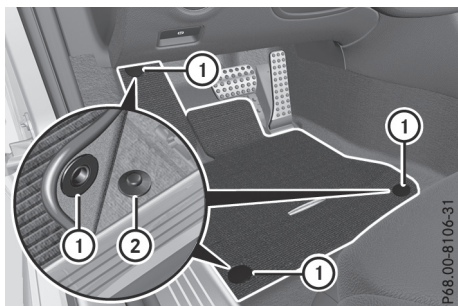

- ▶ Slide the seat back.
- ▶ **To install:** place the floor mat in the footwell.
- ▶ Press studs ① onto retainers ②.
- ▶ **To remove:** pull the floor mat off retainers ②.
- ▶ Remove the floor mat.



## Engine compartment

### Hood

#### Important safety notes

##### WARNING

If the hood is unlatched, it may open up when the vehicle is in motion and block your view. There is a risk of an accident.

Never unlatch the hood while driving. Before every trip, ensure that the hood is locked.

##### WARNING

When opening and closing the hood, it may suddenly fall into the closed position. There is a risk of injury to persons within range of movement of the hood.

Open and close the hood only when no one is within its range of movement.

##### WARNING

Opening the hood when the engine is overheated or when there is a fire in the engine compartment could expose you to hot gases or other service products. There is a risk of injury.

Let an overheated engine cool down before opening the hood. If there is a fire in the engine compartment, keep the hood closed and contact the fire department.

##### WARNING

The engine compartment contains moving components. Certain components, such as the radiator fan, may continue to run or start again suddenly when the ignition is off. There is a risk of injury.

If you need to do any work inside the engine compartment:

- switch off the ignition
- never reach into the area where there is a risk of danger from moving components, such as the fan rotation area

- remove jewelry and watches
- keep items of clothing and hair, for example, away from moving parts

To ensure the flow of fresh air through the air vents into the vehicle interior, please observe the following notes: (▷ page 122)

#### Opening the hood

##### WARNING

Certain components in the engine compartment, such as the engine, radiator and parts of the exhaust system, can become very hot. Working in the engine compartment poses a risk of injury.

Where possible, let the engine cool down and touch only the components described in the following.

##### WARNING

When the hood is open and the windshield wipers are set in motion, you can be injured by the wiper linkage. There is a risk of injury. Always switch off the windshield wipers and the ignition before opening the hood.

- ! Make sure that the windshield wipers are not folded away from the windshield. You could otherwise damage the windshield wipers or the hood.

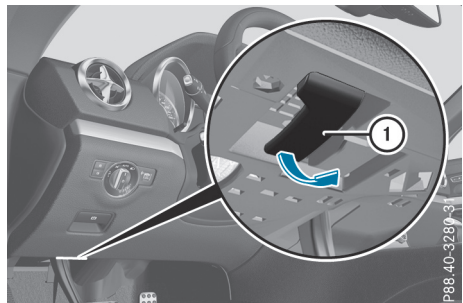

- ▶ Make sure that the windshield wipers are turned off.
- ▶ Pull release lever ① on the hood. The hood is released.

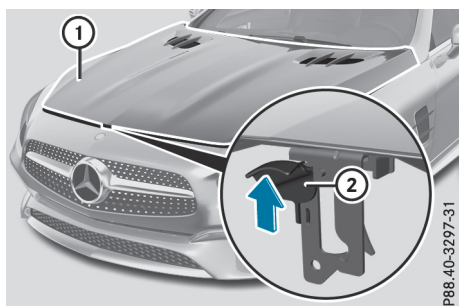

- ▶ Reach into the gap, pull hood catch handle ② up and lift hood ①.  
If you lift the hood by approximately 15 in (40 cm), the hood is opened and held open automatically by the gas-filled strut.

### Closing the hood

- ▶ Lower the hood and let it fall from a height of approximately 8 in (20 cm).
- ▶ Check that the hood has engaged properly. If the hood can be raised slightly, it is not properly engaged. Open it again and close it with a little more force.

## Engine oil

### Notes on the oil level

Depending on your driving style, the vehicle consumes up to 0.9 US qt (0.8 liters) of oil per 600 miles (1,000 km). The oil consumption may be higher than this when the vehicle is new or if you frequently drive at high engine speeds.

Depending on the engine, the oil dipstick may be in a different location.

When checking the oil level:

- park the vehicle on a level surface
- the engine should be switched off for approximately five minutes if the engine is at normal operating temperature
- if the engine is not at normal operating temperature, e.g. if the engine was only started briefly, wait about 30 minutes before carrying out the measurement

### Checking the oil level using the oil dipstick

#### ⚠ WARNING

Certain components in the engine compartment, such as the engine, radiator and parts of the exhaust system, can become very hot. Working in the engine compartment poses a risk of injury.

Only touch the following components described.

If work is being carried out on public roads, pay attention to the road and traffic conditions and secure the area as appropriate.

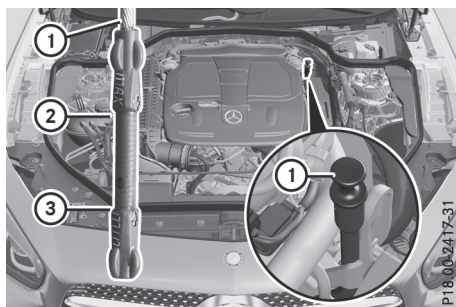

Example

- ▶ Pull out oil dipstick ①.
- ▶ Wipe off oil dipstick ①.
- ▶ Slowly slide oil dipstick ① into the guide tube as far as it will go, and take it out again.  
If the level is between MIN mark ③ and MAX mark ②, the oil level is correct.
- ▶ If the oil level has dropped to MIN mark ③ or below, add 1.1 US qt (1 l) of engine oil.

### Adding engine oil

#### ⚠ WARNING

Certain components in the engine compartment, such as the engine, radiator and parts of the exhaust system, can become very hot. Working in the engine compartment poses a risk of injury.

Where possible, let the engine cool down and touch only the components described in the following.

**⚠ WARNING**

If engine oil comes into contact with hot components in the engine compartment, it may ignite. There is a risk of fire and injury. Make sure that engine oil is not spilled next to the filler neck. Let the engine cool down and thoroughly clean the engine oil off the components before starting the engine.

**🌿 Environmental note**

When adding oil, take care not to spill any. If oil enters the soil or waterways, it is harmful to the environment.

**!** Use only engine oils and oil filters that are approved for vehicles with a service system. A list of the engine oils and oil filters that have been tested and approved in accordance with Mercedes-Benz Specifications for Service Products is available at any authorized Mercedes-Benz Center.

The following cause engine failure or damage to the exhaust system:

- Use of engine oils and oil filters that have not been expressly approved for the service system
- Replacement of engine oil and oil filter after the replacement interval specified by the service system has expired
- Use of engine oil additives

**!** Do not add too much oil. If the oil level is above the "max" mark on the dipstick, too much oil has been added. This can lead to damage to the engine or the catalytic converter. Have excess oil siphoned off.

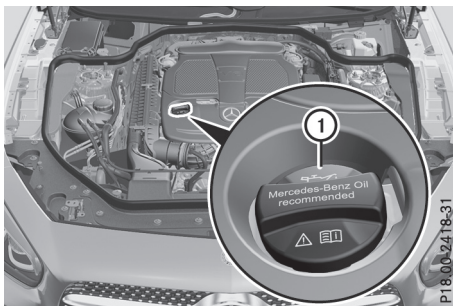

Example: engine oil cap

- ▶ Turn cap ① counter-clockwise and remove it.
- ▶ Add engine oil.  
If the oil level is at or below the MIN mark on the oil dipstick, add 1.1 US qt (1.0 liter) of engine oil.
- ▶ Replace cap ① on the filler neck and turn clockwise.  
Ensure that the cap locks into place securely.
- ▶ Check the oil level again with the oil dipstick (> page 266).

Further information on engine oil (> page 323).

**Checking and adding other service products****Checking coolant level****⚠ WARNING**

Certain components in the engine compartment, such as the engine, radiator and parts of the exhaust system, can become very hot. Working in the engine compartment poses a risk of injury.

Where possible, let the engine cool down and touch only the components described in the following.

**⚠ WARNING**

Opening the hood when the engine is overheated or when there is a fire in the engine compartment could expose you to hot gases or other service products. There is a risk of injury.

Let an overheated engine cool down before opening the hood. If there is a fire in the engine compartment, keep the hood closed and contact the fire department.

**⚠ WARNING**

The engine compartment contains moving components. Certain components, such as the radiator fan, may continue to run or start again suddenly when the ignition is off. There is a risk of injury.

If you need to do any work inside the engine compartment:

- switch off the ignition
- never reach into the area where there is a risk of danger from moving components, such as the fan rotation area
- remove jewelry and watches
- keep items of clothing and hair, for example, away from moving parts

### WARNING

The cooling system is pressurized, particularly when the motor is warm. If you open the cap, you could be scalded if hot coolant sprays out. There is a risk of injury.

Let the engine cool down before you open the cap. Wear protective gloves and protective eyewear when opening. Open the cap slowly to release pressure.

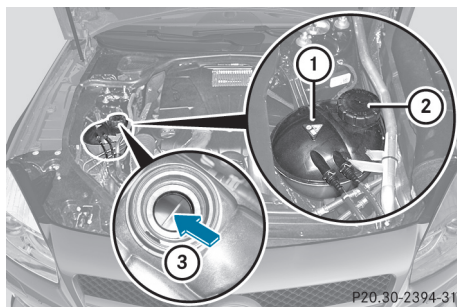

P20\_30-2394\_31

Example

- ▶ Park the vehicle on a level surface.  
Only check the coolant level when the vehicle is on a level surface and the engine has cooled down.
- ▶ Turn the SmartKey to position **2** in the ignition lock (▷ page 126).  
On vehicles with KEYLESS-GO, press the Start/Stop button twice (▷ page 126).
- ▶ Check the coolant temperature gage in the multifunction display.  
The coolant temperature must be below 158 °F (70 °C).
- ▶ Turn the SmartKey to position **0** (▷ page 126) in the ignition lock.

- ▶ Slowly turn cap **2** half a turn counter-clockwise to allow excess pressure to escape.
- ▶ Turn cap **2** further counter-clockwise and remove it.

If the coolant is at the level of marker bar **3** in the filler neck when cold, there is enough coolant in coolant expansion tank **1**.

If the coolant level is approximately 0.6 in (1.5 cm) above marker bar **3** in the filler neck when warm, there is enough coolant in expansion tank **1**.

- ▶ If necessary, add coolant that has been tested and approved by Mercedes-Benz.
- ▶ Replace cap **2** and turn it clockwise as far as it will go.

Further information on coolant (▷ page 324).

### Windshield washer system

#### WARNING

Certain components in the engine compartment, such as the engine, radiator and parts of the exhaust system, can become very hot. Working in the engine compartment poses a risk of injury.

Where possible, let the engine cool down and touch only the components described in the following.

#### WARNING

If you open the hood when the drive system has overheated or during a fire in the engine compartment, you could come into contact with hot gases or other escaping operating fluids. There is a risk of burns.

Let the overheated components cool down before opening the hood. In the event of a fire in the engine compartment, keep the hood closed and call the fire service.

#### WARNING

Windshield washer concentrate is highly flammable. If windshield washer concentrate gets onto hot components of the engine or the exhaust system, it can ignite. There is a risk of fire and injury.

Make sure that windshield washer concentrate is not spilled in the vicinity of the filler neck.

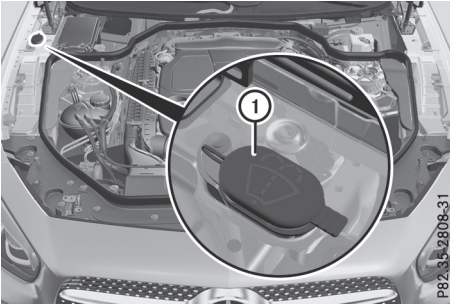

Example

- ▶ **To open:** pull cap ① upwards by the tab.
- ▶ Add the premixed washer fluid.
- ▶ **To close:** press cap ① onto the filler neck until it engages.

If the washer fluid level drops below the recommended minimum fluid level of 1 US qt (1 liter), a message appears in the multifunction display prompting you to add washer fluid (▷ page 231).

Further information on windshield washer fluid/antifreeze (▷ page 325).

## Overview of the engine compartment

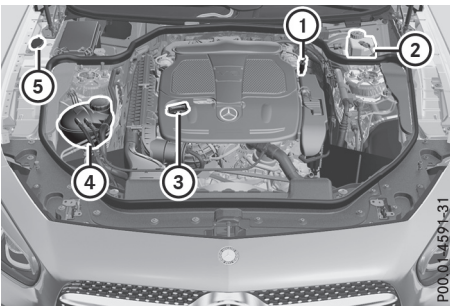

Example engine

- ① Oil dipstick
- ② Brake fluid reservoir
- ③ Engine oil cap
- ④ Coolant expansion tank
- ⑤ Washer fluid reservoir

## ASSYST PLUS

### Service display

The ASSYST PLUS service interval display indicates the remaining time period or the remaining distance to the next regular service due date.

Information on the type of service and service intervals (see the separate Maintenance Booklet).

You can obtain further information from an authorized Mercedes-Benz Center or at <http://www.mbusa.com> (USA only).

- ❗ The ASSYST PLUS service interval display does not show any information on the engine oil level. Observe the notes on the engine oil level (▷ page 266).

The multifunction display shows a service display for a few seconds, e.g.:

- Service A in .. Days
- Service A Due
- Service A Exceeded by .. Days

Depending on the operating conditions of the vehicle, the remaining time or distance until the next service due date is displayed.

The letter **A** or **B**, possibly in connection with a number or another letter, shows the type of service. **A** stands for a minor service and **B** for a major service.

You can obtain further information from an authorized Mercedes-Benz Center.

Depending on how the vehicle is used, the ASSYST PLUS service interval display may reduce the service interval, e.g. in the following situations:

- ▶ the vehicle is primarily used to travel short distances
- ▶ if the engine is often left idling for long periods
- ▶ if there are frequent cold start phases

Mercedes-Benz recommends you avoid such operating conditions.

The ASSYST PLUS service interval display does not take into account any periods of time during which the battery is disconnected.



Maintaining the time-dependent service schedule:

- ▶ Note down the service due date displayed in the multifunction display before disconnecting the battery.





or

- ▶ After reconnecting the battery, subtract the battery disconnection periods from the service date shown on the display.

### Hiding service displays

- ▶ Press the  or  button on the steering wheel.

### Showing service displays

- ▶ Switch on the ignition.
- ▶ Press  or  on the steering wheel to select the **Serv.** menu.
- ▶ Press  or  to select the **ASSYST PLUS** submenu and confirm by pressing the  button.

The service due date appears in the multifunction display.

### Information about Service

#### Resetting the ASSYST PLUS service interval display

- ! If the ASSYST PLUS service interval display has been inadvertently reset, this setting can be corrected at a qualified specialist workshop.

Have service work carried out as described in the Maintenance Booklet. This may otherwise lead to increased wear and damage to the major assemblies or the vehicle.

A qualified specialist workshop, e.g. an authorized Mercedes-Benz Center, will reset the ASSYST PLUS service interval display after the service work has been carried out. You can also obtain further information on maintenance work, for example.

### Special service requirements

The specified maintenance interval takes only the normal operation of the vehicle into account. Service work will need to be performed more often if the vehicle is operated under arduous conditions or increased loads.

The ASSYST PLUS service interval display is only an aid. The driver of the vehicle is responsible for whether service work will need to be performed more frequently than required as a result of the actual operating conditions and/or loads.

Examples of arduous operating conditions:

- regular city driving with frequent intermediate stops
- the vehicle is primarily used to travel short distances
- frequent use in mountainous terrain or on poor road surfaces
- the engine is often left idling for long periods
- particularly dusty conditions, or if air-recirculation mode is frequently used

In these or similar operating conditions, have the interior filter, air filter, engine oil and oil filter, for example, changed more frequently. Under arduous operating conditions, the tires must be checked more often. Further information can be obtained at a qualified specialist workshop.

### Driving abroad

An extensive Mercedes-Benz Service network is also available in other countries. You can obtain further information from any authorized Mercedes-Benz Service Center.

### Care

#### Notes on care

##### Environmental note

Dispose of empty packaging and cleaning cloths in an environmentally responsible manner.

- ! When cleaning your car, do not use:
  - dry, coarse or hard cloths
  - abrasive cleaning agents

- solvents
  - cleaning agents containing solvents
- Do not scrub.

Do not touch the surfaces and films with hard objects, e.g. rings or ice scrapers. Otherwise, you may scratch or damage the surfaces and films.

- !** Do not park your vehicle for a long period of time directly after cleaning, particularly after cleaning the wheel rim with wheel cleaner. Wheel cleaner can lead to the increased corrosion of the brake discs and pads. Therefore, drive for a few minutes after cleaning. By heating up the brakes, the brake discs and pads dry. The vehicle can then be parked for a long period of time.

Regular care of your vehicle is a condition for retaining the quality in the long term.

Use care products and cleaning agents recommended and approved by Mercedes-Benz.

## Washing the vehicle and cleaning the paintwork

### Automatic car wash

#### WARNING

Braking efficiency is reduced after washing the vehicle. There is a risk of an accident.

After the vehicle has been washed, brake carefully while paying attention to the traffic conditions until full braking power is restored.

- !** When DISTRONIC PLUS or the HOLD function is activated, the vehicle brakes automatically in certain situations.

To avoid damage to the vehicle, deactivate DISTRONIC PLUS and the HOLD function in the following or similar situations:

- when towing the vehicle
- in the car wash

- !** It is preferable to use car washes with adjustable high-pressure pre-cleaning that corresponds to the specification for the Cabriolet program. In car washes that use high water pressures, there is a risk that a small amount of water may leak into the vehicle.

- !** Vehicles with HANDS-FREE ACCESS: if a SmartKey with KEYLESS-GO is within the detection range of the KEYLESS-GO antenna, the following situations could lead to the unintentional opening of the trunk lid:

- using a car wash
- using a power washer

Make sure that the SmartKey is at least 6.5 ft (2 m) away from the vehicle.

- !** Never clean your vehicle in a Touchless Automatic Car Wash as these use special cleaning agents. These cleaning agents can damage the paintwork or plastic parts.

If you have your vehicle cleaned in a high-pressure automatic car wash, small amounts of water may enter the vehicle.

- !** Make sure that the automatic transmission is in position **N** when washing your vehicle in a tow-through car wash. The vehicle could be damaged if the transmission is in another position.

- !** Make sure that:

- the side windows and the roof are completely closed
- the climate control blower is switched off
- the windshield wiper switch is at position **0**

The vehicle could otherwise be damaged.

You can clean the vehicle at an automatic car wash from the very start.

Preferably clean the vehicle at automatic car washes that use textile washing elements without brushes. This prevents fine scratches from forming on the paintwork and film.

If the vehicle is very dirty, pre-wash it before cleaning it in an automatic car wash.

After using an automatic car wash, wipe off wax from the windshield and the wiper blades. This will prevent smears and reduce wiping noises caused by residue on the windshield.

- i** Vehicles with decorative film: select a wash program without hot wax at the automatic car wash.

### Washing by hand

In some countries, washing by hand is only allowed at specially equipped washing bays.



Observe the legal requirements in each country.

- ▶ Do not use hot water and do not wash the vehicle in direct sunlight.
- ▶ Use a soft sponge to clean.
- ▶ Use a mild cleaning agent, such as a car shampoo approved by Mercedes-Benz.
- ▶ Thoroughly hose down the vehicle with a gentle jet of water.
- ▶ Do not point the water jet directly towards the air inlet or the edges of decorative foils.
- ▶ Use plenty of water and rinse out the sponge frequently.
- ▶ Rinse the vehicle with clean water and dry thoroughly with a chamois.
- ▶ Do not let the cleaning agent dry on the paintwork or the decorative foils.

Carefully remove all deposits of road salt as soon as possible when driving in winter.

## Power washers

### WARNING

The water jet from a circular jet nozzle (dirt blasters) can cause invisible exterior damage to the tires or chassis components. Components damaged in this way may fail unexpectedly. There is a risk of an accident.

Do not use power washers with circular jet nozzles to clean the vehicle. Have damaged tires or chassis components replaced immediately.

- ❗ Vehicles with decorative film: parts of your vehicle are covered with decorative film. Maintain a distance of at least 27.5 in (70 cm) between the film-covered parts of the vehicle and the nozzle of the power washer.

Information about the correct distance is available from the equipment manufacturer. Move the power washer nozzle around when cleaning your vehicle.

The water temperature of the power washer must not exceed 140 °F (60 °C).

- ❗ Always maintain a distance of at least 12 in (30 cm) between the vehicle and the power washer nozzle. Information about the correct distance is available from the equipment manufacturer.

Move the power washer nozzle around when cleaning your vehicle.

Do not aim directly at any of the following:

- Tires
- Door gaps, roof gaps, joints, etc.
- Electrical components
- Battery
- Plug-type couplings
- Light bulbs
- Seals
- Trim elements
- Ventilation slots

Damaged seals or electrical components can lead to leaks or failures.

- ❗ Vehicles with HANDS-FREE ACCESS: if a SmartKey with KEYLESS-GO is within the detection range of the KEYLESS-GO antenna, the following situations could lead to the unintentional opening of the trunk lid:

- using a car wash
- using a power washer

Make sure that the SmartKey is at least 6.5 ft (2 m) away from the vehicle.

## Cleaning the paintwork

- ❗ Do not affix:

- stickers
- films
- magnetic plates or similar items to painted surfaces. You could otherwise damage the paintwork.

Scratches, corrosive deposits, areas affected by corrosion and damage caused by inadequate care cannot always be completely repaired. In such cases, visit a qualified specialist workshop.

- ▶ Remove dirt immediately, where possible, while avoiding rubbing too hard.
- ▶ Soak insect remains with insect remover and rinse off the treated areas afterwards.
- ▶ Soak bird droppings with water and rinse off the treated areas afterwards.
- ▶ Remove tree resin, oils, fuels and greases by rubbing gently with a cloth soaked in petroleum ether or lighter fluid
- ▶ Remove coolant and brake fluid with a moist cloth and clear water.

- ▶ Use tar remover to remove tar stains.
- ▶ Use silicone remover to remove wax.

If water no longer forms "beads" on the paint surface, use the paint care products recommended and approved by Mercedes-Benz. This is the case approximately every three to five months, depending on the climate conditions and the care product used.

If dirt has penetrated the paint surface or if the paint has become dull, the paint cleaner recommended and approved by Mercedes-Benz should be used.

Do not use these care products in the sun or on the hood while the hood is hot.

- ▶ Use a suitable touch-up stick, e.g. MB Touch-Up Stick, to repair slight damage to the paintwork quickly and provisionally.

### Matte finish care

❗ Never polish the vehicle or the light alloy wheels. Polishing causes the finish to shine.

❗ The following can give the paint a glossy appearance and thus reduce the matt effect:

- Rubbing hard with unsuitable agents
- Washing the vehicle in direct sunlight

❗ Never use paint cleaner, buffing or polishing products, or gloss preserver, e.g. wax, for the purpose of paintwork care. These products are only suitable for high-gloss surfaces. Their use on vehicles with matte paintwork leads to considerable surface damage or, more specifically, to shiny, spotted areas.

Always have paintwork repairs carried out at a qualified specialist workshop.

❗ Only use automatic car washes which correspond to the latest technological standards. Never use wash programs which finish by treating the vehicle with hot wax.

Observe these notes if your vehicle has a clear matte finish. This will help you to avoid damage to the paintwork due to incorrect treatment.

These notes also apply to light alloy wheels with a clear matte finish.

- ❗ Use only insect remover and car shampoo from the range of recommended and approved Mercedes-Benz care products.

### Cleaning the decorative film

❗ The following may have an effect on the service life and color of decorative film:

- sunlight
- temperature, e.g. hot-air fan
- weather conditions
- stone impacts and dirt
- chemical cleaning agents
- greasy substances

❗ Do not use any types of polish on matt decorative film. Polishing surfaces covered with film gives it a shiny finish.

❗ Do not treat matt or structured decorative film with wax. This may lead to marks that cannot be removed.

Observe the notes in the section on the care and treatment of matte paintwork (> page 273); these notes also apply to matte decorative film.

To clean, use plenty of water and a mild cleaning agent without additional or abrasive products, e.g. a car shampoo approved by Mercedes-Benz.

- ▶ Dry vehicles covered with film using a soft, absorbent cloth after every wash. Water marks could otherwise form.

Scratches, corrosive deposits, areas affected by corrosion and damage caused by inadequate care cannot always be completely repaired. In such cases, visit a qualified specialist workshop.

- ▶ Remove dirt immediately, where possible, while avoiding rubbing too hard. The decorative film may be irreparably damaged.
- ▶ Soak insect remains with insect remover and rinse off the treated areas afterwards.
- ▶ Soak bird droppings with water and rinse off the treated areas afterwards.

The cleaning product, Paint Cleaner, which has been approved and recommended by Mercedes-Benz, should be used when dirt has penetrated the decorative film surface or the decorative film has become dull.

The manufacturer can provide you with information on special care and cleaning products. Laminated surfaces may exhibit optical differences to surfaces which were not protected by

a decorative film when the decorative film is removed.

- i** Have work or repairs on decorative film carried out at a qualified specialist workshop. Mercedes-Benz recommends that you use an authorized Mercedes-Benz Center for this purpose.

## Cleaning the vehicle parts

### Cleaning the wheels

#### WARNING

The water jet from a circular jet nozzle (dirt blasters) can cause invisible exterior damage to the tires or chassis components. Components damaged in this way may fail unexpectedly. There is a risk of an accident. Do not use power washers with circular jet nozzles to clean the vehicle. Have damaged tires or chassis components replaced immediately.

- !** Do not use acidic wheel cleaning products to remove brake dust. This could damage wheel bolts and brake components.
- !** Do not park your vehicle for a long period of time directly after cleaning, particularly after cleaning the wheel rim with wheel cleaner. Wheel cleaner can lead to the increased corrosion of the brake discs and pads. Therefore, drive for a few minutes after cleaning. By heating up the brakes, the brake discs and pads dry. The vehicle can then be parked for a long period of time.

### Cleaning the windows

#### WARNING

You could become trapped by the windshield wipers if they start moving while cleaning the windshield or wiper blades. There is a risk of injury.

Always switch off the windshield wipers and the ignition before cleaning the windshield or wiper blades.

- !** Only fold the windshield wipers away from the windshield when vertical. Otherwise, you will damage the hood.
- !** Do not use dry cloths, abrasive products, solvents or cleaning agents containing solvents to clean the inside of the windows. Do not touch the insides of the windows with hard objects, e.g. an ice scraper or ring. There is otherwise a risk of damaging the windows.
- !** Clean the water drainage channels of the windshield and the rear window at regular intervals. Deposits such as leaves, petals and pollen may under certain circumstances prevent water from draining away. This can lead to corrosion damage and damage to electronic components.
- ▶ Clean the inside and outside of the windows with a damp cloth and a cleaning product that is recommended and approved by Mercedes-Benz.

### Cleaning wiper blades

#### WARNING

If the windshield wipers are set in motion while you are cleaning the windshield, you can be trapped by the wiper arm. There is a risk of injury.

Always switch off the windshield wipers and the ignition before cleaning the windshield.

- !** Do not pull the wiper blade. Otherwise, the wiper blade could be damaged.
- !** Do not clean wiper blades too often and do not rub them too hard. Otherwise, the graphite coating could be damaged. This could cause wiper noise.
- !** Hold the wiper arm securely when folding back. The windshield could be damaged if the wiper arm smacks against it suddenly.
- ▶ Fold the windshield wiper arms away from the windshield.
- ▶ Carefully clean the wiper blades with a damp cloth.
- ▶ Fold the windshield wiper arms back again before switching on the ignition.

## Cleaning the exterior lighting

- ❗ Only use cleaning agents or cleaning cloths that are suitable for plastic lenses. Caustic, irritant or otherwise unsuitable cleaning agents or cleaning cloths could scratch or damage the exterior lighting plastic lenses.
- ▶ Clean the plastic lenses of the exterior lights with a wet sponge and a mild cleaning agent, e.g. Mercedes-Benz car shampoo or cleaning cloths.

## Cleaning the mirror turn signals

- ❗ Only use cleaning agents or cleaning cloths that are suitable for plastic lenses. Unsuitable cleaning agents or cleaning cloths could scratch or damage the plastic lenses of the mirror turn signals.
- ▶ Clean the plastic lenses of the mirror turn signals in the exterior mirror housing using a wet sponge and mild cleaning agent, e.g. Mercedes-Benz car shampoo or with cleaning cloths.

## Cleaning the sensors

- ❗ If you clean the sensors with a power washer, make sure that you keep a distance of at least 11.8 in (30 cm) between the vehicle and the power washer nozzle. Information about the correct distance is available from the equipment manufacturer.

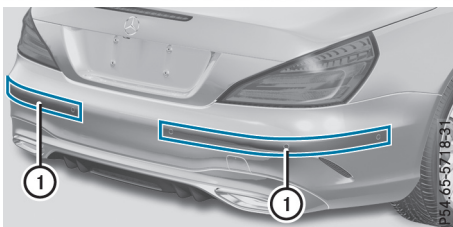
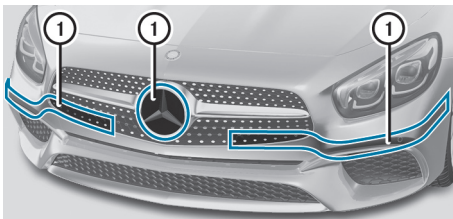

- ▶ Clean sensors ① of the driving systems with water, car shampoo and a soft cloth.

## Cleaning the reversing camera

- ❗ Do not clean the camera lens and the area around the rear view camera with a power washer.

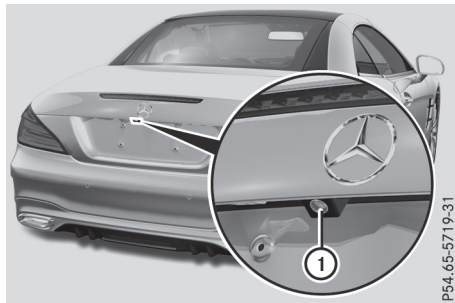

- ▶ Use clean water and a soft cloth to clean camera lens ①.

## Cleaning the exhaust pipe

### ⚠ WARNING

The exhaust tail pipe and tail pipe trim can become very hot. If you come into contact with these parts of the vehicle, you could burn yourself. There is a risk of burns.

Always be particularly careful and supervise children closely around the exhaust pipe and the exhaust pipe trims. Allow these components to cool down before touching them.

- ❗ Do not clean the exhaust pipe with acid-based cleaning agents, such as bathroom cleaner or wheel cleaner.
- ▶ Clean the exhaust pipe with a chrome care product tested and approved by Mercedes-Benz.

Impurities combined with the effects of road grit and corrosive environmental factors may cause flash rust to form on the surface. You can restore the original shine of the exhaust pipe by cleaning it regularly, especially in winter and after washing.

## Where will I find...?

## Warning triangle

## Removing the warning triangle

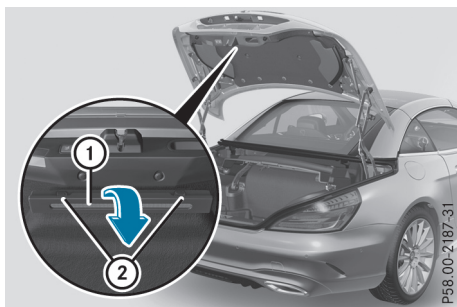

Warning triangle ① is located in a bracket on the inside of the trunk lid.

- ▶ Open the trunk lid.
- ▶ Press catches ② in the direction of the bracket and open the bracket in the direction of the arrow.
- ▶ Pull the retaining clip of warning triangle ① in the center of the bracket, outward.
- ▶ Remove warning triangle ① from the bracket.

## Setting up the warning triangle

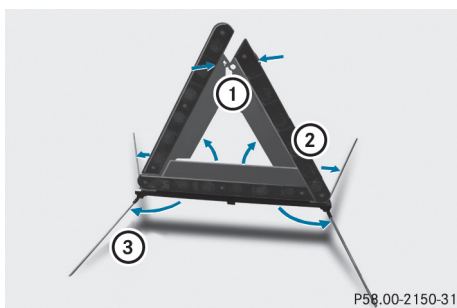

- ▶ Fold feet ③ down and out to the side.
- ▶ Pull side reflectors ② upwards to form a triangle and lock them at the top using upper press-stud ①.

## First-aid kit



First-aid kit ① is located in the stowage well under the trunk floor.

- ▶ Lift the trunk floor upwards (▷ page 252).
- ▶ Remove first-aid kit ①.

Check the expiration date on the first-aid kit at least once a year. Replace the contents if necessary, and replace missing items.

## Reflective safety jacket

## Removing/replacing reflective safety jackets

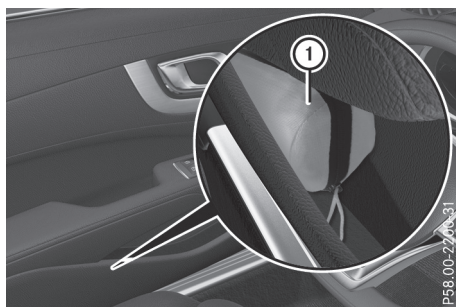

The reflective safety jackets are located in the safety jacket compartments in the stowage compartments of the front doors. There are also safety jacket compartments in the stowage compartments of the rear doors, in which reflective safety jackets can be stowed.

- ▶ **To remove:** pull out safety jacket bag ① with the reflective safety jacket by the loop.
- ▶ Open safety jacket bag ① and pull out the reflective safety jacket.

- ▶ **To stow:** fold the reflective safety jacket, roll it up and stow it in safety jacket bag ①.
- ▶ Slide safety jacket bag ① along the lower edge of the armrest into the safety jacket compartment. Meanwhile, ensure that the loop hangs out well within reach.

**i** Remove a new reflective safety jacket from its packaging material before sliding it into the safety jacket compartment. The packaging material may otherwise cause it to slip out or make removing it difficult.

Observe the legal requirements in each country.

### Notes on the reflective safety jacket

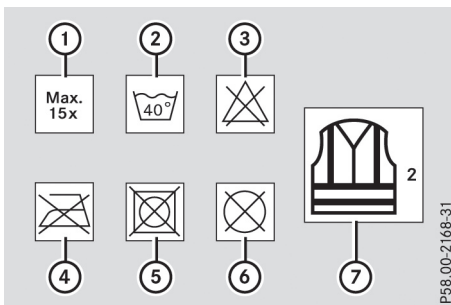

- ① Maximum number of washes
- ② Maximum wash temperature
- ③ Do not bleach
- ④ Do not iron
- ⑤ Do not use a laundry dryer
- ⑥ Do not dry-clean
- ⑦ This is a class 2 vest

- The reflective safety jackets meet the requirements defined by the legal standard only if:
  - the correct size is used and
  - the reflective safety jacket is correctly fastened
- Before use, ensure that the reflective safety jacket is clean and intact. The special properties may otherwise be compromised.
- The reflective safety jackets should be stored in their original packaging in a dry place away from sources of heat and light.
- The maximum number of washes specified is not the only factor influencing the life span of the reflective safety jackets. Their life span also depends on use, care, storage, etc.

- The reflective safety jackets should be disposed of and replaced with new ones:
  - after 15 washes, and/or
  - if the reflective strips have become scratched, and/or
  - if the backing material and/or reflective strips have become soiled and cannot be cleaned off, and/or
  - the reflective safety jacket's fluorescence has faded, e.g. due to the effects of sunlight
- Dispose of the reflective safety jacket in an environmentally responsible manner. To do so, contact your local waste disposal company.

### Vehicle tool kit

#### General notes

The towing eye is located in the trunk in a bracket below the trunk lid lock.

If your vehicle is equipped with a TIREFIT kit, it is located in the stowage space under the trunk floor.

#### Vehicles with a TIREFIT kit

The TIREFIT kit is located in the stowage well under the trunk floor (▶ page 252).

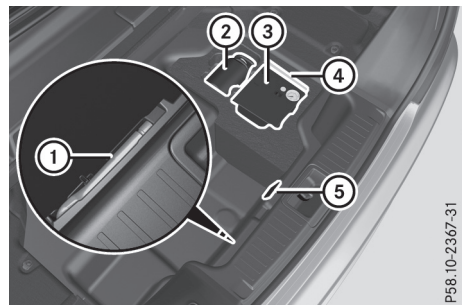

- ① Towing eye
- ② Tire sealant filler bottle
- ③ Fuse allocation chart
- ④ Tire inflation compressor
- ⑤ Stowage tray opening

- ▶ To remove towing eye ① raise the opening on stowage tray ⑤.
- ▶ Use the TIREFIT kit (▶ page 279).



## Tire-change tool kit

The tire-change tool kit can be found in the storage well under the trunk floor (▷ page 252).

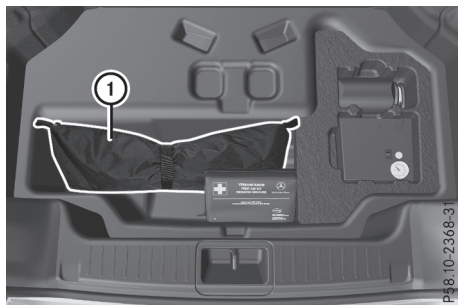

① Bag containing the tire-changing tools  
Bag ① with the tire-changing tools contains:

- jack
- lug wrench
- alignment bolt
- wheel chock
- gloves

Depending on the equipment, tools required for a wheel change, such as a jack or a lug wrench, are not available in all vehicles. Tools approved for your vehicle are available at a qualified specialist workshop.

## Flat tire

### Preparing the vehicle

Your vehicle may be equipped with:

- tires with run-flat characteristics (MOExtended tires) (▷ page 278)  
Vehicle preparation is not necessary on vehicles with MOExtended tires.
- a TIREFIT kit (▷ page 277)

**Vehicles with the Mercedes-Benz emergency call system:** in the event of a flat tire, you can contact the Mercedes-Benz emergency call system customer center.

Vehicles equipped with MOExtended tires are not equipped with a TIREFIT kit at the factory. It is therefore recommended that you additionally equip your vehicle with a TIREFIT kit if you mount tires that do not feature run-flat characteristics, e.g. winter tires. A TIREFIT kit may be obtained from a qualified specialist workshop.

Information on changing and mounting wheels (▷ page 313).

- ▶ Stop the vehicle on solid, non-slippery and level ground, as far away as possible from traffic.
- ▶ Switch on the hazard warning lamps.
- ▶ Secure the vehicle against rolling away (▷ page 146).
- ▶ If possible, bring the front wheels into the straight-ahead position.
- ▶ Switch off the engine.
- ▶ **Vehicles without KEYLESS-GO:** remove the SmartKey from the ignition lock.
- ▶ **Vehicles with KEYLESS-GO:** open the driver's door.

The vehicle electronics are now in position **0**. This is the same as the SmartKey having been removed.

- ▶ **Vehicles with KEYLESS-GO:** remove the Start/Stop button from the ignition lock (▷ page 126).
- ▶ Make sure that the passengers are not endangered as they do so. Make sure that no one is near the danger area while a wheel is being changed. Anyone who is not directly assisting in the wheel change should, for example, stand behind the barrier.
- ▶ Get out of the vehicle. Pay attention to traffic conditions when doing so.
- ▶ Close the driver's door.

### MOExtended tires (tires with run-flat properties)

#### General notes

With MOExtended tires (tires with run flat characteristics), you can continue to drive your vehicle even if there is a total loss of pressure in one or more tires. The affected tire must not show any clearly visible damage.

You can recognize an MOExtended tire by the MOExtended marking which appears on the sidewall of the tire. You will find this marking next to the tire size designation, the load-bearing capacity and the speed index (▷ page 307).

MOExtended tires may only be used in conjunction with an active tire pressure monitor.



### If a pressure loss warning message appears in the multifunction display:

- observe the instructions in the display messages (> page 227)
- check the tire for damage
- if driving on, observe the following notes

The driving distance possible in run-flat mode is approximately 50 miles (80 kilometers) when the vehicle is partially laden and approximately 19 miles (30 kilometers) when the vehicle is fully laden.

In addition to the vehicle load, the driving distance possible depends upon:

- Vehicle speed
- Road condition
- Outside temperature

The driving distance possible in run-flat mode may be reduced by extreme driving conditions or maneuvers, or it can be increased through a moderate style of driving.

The driving distance possible in run-flat mode is counted from the moment the tire pressure loss warning appears in the multifunction display.

You must not exceed a maximum design speed of 50 mph (80 km/h).

When replacing one or all tires, please observe the following specifications for your vehicle's tires:

- Size
- Type and
- The "MOExtended" mark

If a tire has gone flat and cannot be replaced with an MOExtended tire, a standard tire may be used as a temporary measure. Make sure that you use the proper size and type (summer or winter tire).

Vehicles equipped with MOExtended tires are not equipped with a TIREFIT kit at the factory. It is therefore recommended that you additionally equip your vehicle with a TIREFIT kit if you mount tires that do not feature run-flat characteristics, e.g. winter tires. A TIREFIT kit can be obtained from a qualified specialist workshop, for example.

### Important safety notes

#### WARNING

When you drive in emergency mode, the handling characteristics are impaired. e.g. when cornering, when accelerating strongly and when braking. There is a risk of an accident.

Do not exceed the maximum specified speed. Avoid any abrupt steering and driving maneuvers as well as driving over obstacles (curbs, pot holes, off-road). This applies, in particular, to a loaded vehicle.

Stop driving in emergency mode if you notice:

- banging noise
- vehicle vibration
- smoke which smells like rubber
- continuous ESP® intervention
- cracks in the tire side walls

After driving in emergency mode, have the rims checked by a qualified specialist workshop with regard to their further use. The defective tire must be replaced in every case.

#### TIREFIT kit

### Important safety notes

TIREFIT is a tire sealant.

You can use TIREFIT to seal punctures of up to 0.16 in (4 mm), particularly those in the tire tread. You can use TIREFIT at outside temperatures down to -4 °F (-20 °C).

#### WARNING

In the following situations, the tire sealant is unable to provide sufficient breakdown assistance, as it is unable to seal the tire properly:

- there are cuts or punctures in the tire larger than those mentioned above.
- the wheel rim is damaged.
- you have driven at very low tire pressures or on a flat tire.

There is a risk of an accident.

Do not drive the vehicle. Contact a qualified specialist workshop.

### WARNING

The tire sealant is harmful and causes irritation. It must not come into contact with your skin, eyes or clothing or be swallowed. Do not inhale TIREFIT fumes. Keep tire sealant away from children. There is a risk of injury.

If you come into contact with the tire sealant, observe the following:

- Rinse off the tire sealant from your skin immediately with water.
- If the tire sealant comes into contact with your eyes, immediately rinse them thoroughly with clean water.
- If tire sealant is swallowed, immediately rinse your mouth out thoroughly and drink plenty of water. Do not induce vomiting, and seek medical attention immediately.
- Immediately change out of clothing which has come into contact with tire sealant.
- If an allergic reaction occurs, seek medical attention immediately.

**!** Do not operate the tire inflation compressor for longer than eight minutes at a time without a break. It may otherwise overheat.

The tire inflation compressor can be operated again once it has cooled down.

Comply with the manufacturer's safety instructions on the sticker on the tire inflation compressor.

## Using the TIREFIT kit

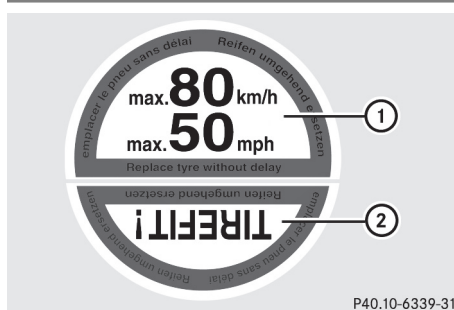

- ▶ Do not remove any foreign objects which have penetrated the tire, e.g. screws or nails.
- ▶ Remove the tire sealant bottle, the accompanying TIREFIT sticker and the tire inflation compressor from the stowage well underneath the trunk floor (> page 277).
- ▶ Affix part ① of the TIREFIT sticker to the instrument cluster within the driver's field of vision.
- ▶ Affix part ② of the TIREFIT sticker near the valve on the wheel with the defective tire.

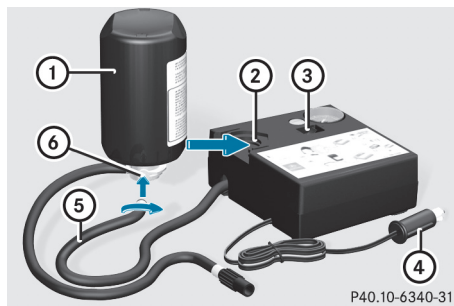

- ▶ Pull plug ④ with the cable and hose ⑤ out of the housing.
- ▶ Screw hose ⑤ onto flange ⑥ of tire sealant bottle ①.
- ▶ Place tire sealant bottle ① head down into recess ② of the tire inflation compressor.

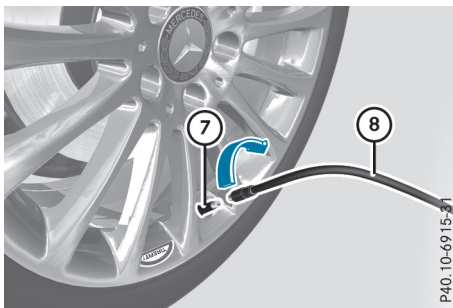

P40-10-6915-971

- ▶ Remove the cap from valve ⑦ on the faulty tire.
- ▶ Screw filler hose ⑧ onto the valve.
- ▶ Insert plug ④ into the socket of the cigarette lighter or into a 12 V power socket in your vehicle.
- ▶ Turn the SmartKey to position ① in the ignition lock (▷ page 126).
- ▶ Press on and off switch ③ on the tire inflation compressor to I.

The tire inflation compressor is switched on. The tire is inflated.  
First, tire sealant is pumped into the tire. The pressure can briefly rise to approximately 500 kPa (5.0 bar/73 psi).

#### **Do not switch off the tire inflation compressor during this phase.**

- ▶ Let the tire inflation compressor run for a maximum of five minutes. The tire should then have attained a pressure of at least 180 kPa (1.8 bar/26 psi).

If a tire pressure of 180 kPa (1.8 bar/26 psi) has been attained after five minutes:  
(▷ page 281).

If a tire pressure of 180 kPa (1.8 bar/26 psi) has not been attained after five minutes:  
(▷ page 281).

If tire sealant has escaped, clean it off affected areas as quickly as possible. It is preferable to use clean water.

If your clothes are soiled with tire sealant, have them cleaned with perchloroethylene at a dry cleaner as soon as possible.

## Tire pressure not reached

If a pressure of 180 kPa (1.8 bar/26 psi) has not been attained after five minutes:

- ▶ Switch off the tire inflation compressor.
- ▶ Unscrew the filler hose from the valve of the faulty tire.  
Note that tire sealant may escape when you unscrew the filler hose.
- ▶ Very slowly drive forwards or reverse approximately 30 ft (10 m).
- ▶ Pump up the tire again.  
After a maximum of five minutes the tire pressure must be at least 180 kPa (1.8 bar/26 psi).

### **⚠ WARNING**

If the required tire pressure is not reached after the specified time, the tire is too badly damaged. The tire sealant cannot repair the tire in this instance. Damaged tires and a tire pressure that is too low can significantly impair the vehicle's braking and driving characteristics. There is a risk of accident.  
Do not continue driving. Contact a qualified specialist workshop.

## Tire pressure reached

### **⚠ WARNING**

A tire temporarily sealed with tire sealant impairs the vehicle's driving characteristics and is not suitable for driving at higher speeds. There is a risk of an accident.  
Adapt your driving style accordingly and drive carefully. Do not exceed the maximum permissible speed for a tire sealed with tire sealant.

The maximum permissible speed for a tire sealed with tire sealant is 50 mph (80 km/h). The upper part of the TIREFIT sticker must be affixed to the instrument cluster in the driver's field of vision.

- ❗ Residue from the tire sealant may come out of the filler hose after use. This could cause stains.

Therefore, place the filler hose in the plastic bag which contained the TIREFIT kit.

### Environmental note

Have the used tire sealant bottle disposed of professionally, e.g. at a qualified specialist workshop.

If a tire pressure of 180 kPa (1.8 bar/26 psi) has been achieved after a maximum period of ten minutes:

- ▶ Switch off the tire inflation compressor.
- ▶ Unscrew the filler hose from the valve of the faulty tire.
- ▶ Stow the tire sealant bottle and the tire inflation compressor.
- ▶ **Pull away immediately.**
- ▶ Stop after driving for approximately ten minutes and check the tire pressure with the tire inflation compressor. The tire pressure must now be at least 130 kPa (1.3 bar/19 psi).

### WARNING

If the required tire pressure is not reached after driving for a short period, the tire is too badly damaged. The tire sealant cannot repair the tire in this instance. Damaged tires and a tire pressure that is too low can significantly impair the vehicle's braking and driving characteristics. There is a risk of accident.

Do not continue driving. Contact a qualified specialist workshop.

- ▶ In cases such as the one mentioned above, contact an authorized Mercedes-Benz Center. Or call 1-800-FOR-MERCEdes (in the USA) or 1-800-387-0100 (in Canada).
- ▶ Correct the tire pressure if it is still at least 130 kPa (1.3 bar/19 psi). See the Tire and Loading Information placard on the driver's side B-pillar or the tire pressure table in the fuel filler flap for values.
- ▶ **To increase the tire pressure:** switch on the tire inflation compressor.

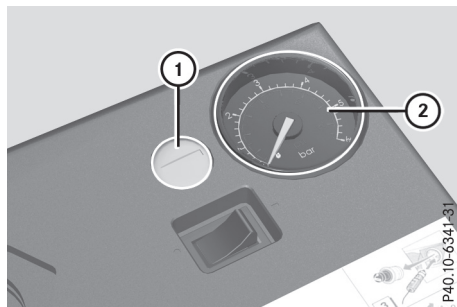

- ▶ **To reduce the tire pressure:** depress pressure release button ⑨ next to pressure gage ⑩.
- ▶ When the tire pressure is correct, unscrew the filler hose from the valve of the sealed tire.
- ▶ Screw the valve cap onto the tire valve of the sealed tire.
- ▶ Pull the tire sealant bottle out of the tire inflation compressor. The filler hose remains attached to the tire sealant bottle.
- ▶ Drive to the nearest qualified specialist workshop and have the tire changed there.
- ▶ Have the tire sealant bottle replaced as soon as possible at a qualified specialist workshop.
- ▶ Have the tire sealant bottle replaced every four years at a qualified specialist workshop.

## Battery (vehicle)

### Important safety notes

Special tools and expert knowledge are required when working on the battery, e.g. removal and installation. You should therefore have all work involving the battery carried out at a qualified specialist workshop.

### WARNING

Work carried out incorrectly on the battery can lead, for example, to a short circuit and thus damage the vehicle electronics. This can lead to function restrictions applying to safety-relevant systems, e.g. the lighting system, the ABS (anti-lock braking system) or the ESP® (Electronic Stability Program).

The operating safety of your vehicle may be restricted.

You could lose control of the vehicle, for example:

- when braking
- in the event of abrupt steering maneuvers and/or when the vehicle's speed is not adapted to the road conditions

There is a risk of an accident.

In the event of a short circuit or a similar incident, contact a qualified specialist workshop immediately. Do not drive any further. You should have all work involving the battery carried out at a qualified specialist workshop.

For further information about ABS and ESP®, see (> page 60) and (> page 65).

#### **WARNING**

Electrostatic build-up can lead to the creation of sparks, which could ignite the highly explosive gases of a battery. There is a risk of an explosion.

Before handling the battery, touch the vehicle body to remove any existing electrostatic build-up.

The highly flammable gas mixture forms when charging the battery as well as when jump-starting.

Always make sure that neither you nor the battery is electrostatically charged. A build-up of electrostatic charge can be caused, for example:

- by wearing clothing made from synthetic fibers
- due to friction between clothing and seats
- if you push or pull the battery across the carpet or other synthetic materials
- if you wipe the battery with a cloth

#### **WARNING**

During the charging process, a battery produces hydrogen gas. If a short circuit occurs or sparks are created, the hydrogen gas can ignite. There is a risk of an explosion.

- Make sure that the positive terminal of a connected battery does not come into contact with vehicle parts.
- Never place metal objects or tools on a battery.
- It is important that you observe the described order of the battery terminals when connecting and disconnecting a battery.
- When jump-starting, make sure that the battery poles with identical polarity are connected.
- It is particularly important to observe the described order when connecting and disconnecting the jumper cables.
- Never connect or disconnect the battery terminals while the engine is running.

#### **WARNING**

Battery acid is caustic. There is a risk of injury.

Avoid contact with skin, eyes or clothing. Do not inhale any battery gases. Do not lean over the battery. Keep children away from batteries. Wash away battery acid immediately with plenty of clean water and seek medical attention.

#### **Environmental note**



Batteries contain pollutants. It is illegal to dispose of them with the household rubbish. They must be collected separately and disposed of in an environmentally responsible recycling system.



Dispose of batteries in an environmentally responsible manner. Take discharged batteries to a qualified specialist workshop or to a collection point for used batteries.

**!** Have the battery regularly checked at a qualified specialist workshop.

Comply with the service intervals in the Maintenance Booklet, or contact a qualified specialist workshop for more information.

**!** Always have work on batteries carried out at a qualified specialist workshop.

Should it, in exceptional circumstances, be absolutely necessary to disconnect the 12-volt battery yourself, please observe the following:

- Secure the vehicle to prevent it from rolling away.
- Switch off the ignition.
- Disconnect the negative terminal first and then the positive terminal.

After the work has been done, install the battery and replace the cover of the positive terminal clamp firmly.

Comply with safety precautions and take protective measures when handling batteries.



Risk of explosion.



Fire, open flames and smoking are prohibited when handling the battery. Avoid creating sparks.



Battery acid is caustic. Avoid contact with skin, eyes or clothing.

Wear suitable protective clothing, especially gloves, apron and faceguard.

Rinse any acid spills immediately with clear water. Contact a physician if necessary.

Wear eye protection.



Keep children away.



Observe this Operator's Manual.



For safety reasons, Mercedes-Benz recommends that you only use batteries which have

been tested and approved for your vehicle by Mercedes-Benz. These batteries provide increased impact protection to prevent vehicle occupants from suffering acid burns should the battery be damaged in the event of an accident.

In order for the battery to achieve the maximum possible service life, it must always be sufficiently charged.

Like other batteries, the vehicle battery may discharge over time if you do not use the vehicle. In this case, have the battery disconnected at a qualified specialist workshop. You can also charge the battery with a charger recommended by Mercedes-Benz. Contact a qualified specialist workshop for further information.

Have the battery condition of charge checked more frequently if you use the vehicle mainly for short trips or if you leave it standing idle for a lengthy period. Consult a qualified specialist workshop if you wish to leave your vehicle parked for a long period of time.

Remove the SmartKey if you park the vehicle and do not require any electrical consumers. The vehicle will then use very little energy, thus conserving battery power.

After an interruption to the power supply, e.g. due to a discharged battery, you must reset the clock (see the Digital Operator's Manual).

## Charging the battery

### WARNING

During charging and jump-starting, explosive gases can escape from the battery. There is a risk of an explosion.

Particularly avoid fire, open flames, creating sparks and smoking. Ensure there is sufficient ventilation while charging and jump-starting. Do not lean over a battery.

### WARNING

Battery acid is caustic. There is a risk of injury.

Avoid contact with skin, eyes or clothing. Do not inhale any battery gases. Do not lean over the battery. Keep children away from batteries. Wash away battery acid immedi-

ately with plenty of clean water and seek medical attention.

### WARNING

A discharged battery can freeze at temperatures below freezing point. When jump-starting the vehicle or charging the battery, gases can escape from the battery. There is a risk of an explosion.

Allow the frozen battery to thaw out before charging it or jump-starting.

**!** Only use battery chargers with a maximum charging voltage of 14.8 V.

**!** Only charge the battery using the jump-starting connection point.

The jump-starting connection point is in the engine compartment.

If the indicator/warning lamps do not light up at low temperatures, it is very likely that the discharged battery has frozen. In this case, you may neither charge the battery nor jump-start the vehicle. The service life of a thawed-out battery may be shorter. The starting characteristics can be impaired, particularly at low temperatures. Have the thawed-out battery checked at a qualified specialist workshop.

Read the battery charger's operating instructions before charging the battery.

- ▶ Open the hood.
- ▶ Connect the battery charger to the positive terminal and ground point in the same order

as when connecting the donor battery in the jump-starting procedure (> page 285).

### Replacing the 12 V battery

Observe the notes on the 12 V battery (> page 282).

Mercedes-Benz recommends that you have the 12 V battery replaced at a qualified specialist workshop, e.g. at an authorized Mercedes-Benz Center.

If you want to replace the battery yourself, observe the following notes:

- Always replace a defective battery with a battery which meets the specific requirements of the vehicle.

The vehicle is equipped with an AGM (Absorbent Glass Mat) technology battery. Full vehicle functionality is only guaranteed with an AGM battery. For safety reasons, Mercedes-Benz recommends that you only use batteries which have been tested and approved for your vehicle by Mercedes-Benz.

- Use detachable parts such as breather hoses, angled connecting pieces or terminal covers from the battery which is to be replaced.
- Make sure that the vent hose is always connected to the original opening on the battery side.
- Install existing or supplied cell caps to prevent gases or battery acid from escaping.
- Make sure that the detachable parts are connected again in the same way.

## Jump-starting

For the jump-starting procedure, use only the jump-starting connection point in the engine compartment, consisting of a positive terminal and a ground point.

### WARNING

Battery acid is caustic. There is a risk of injury.

Avoid contact with skin, eyes or clothing. Do not inhale any battery gases. Do not lean over the battery. Keep children away from batteries. Wash away battery acid immediately with plenty of clean water and seek medical attention.



 **WARNING**

During charging and jump-starting, explosive gases can escape from the battery. There is a risk of an explosion.

Particularly avoid fire, open flames, creating sparks and smoking. Ensure there is sufficient ventilation while charging and jump-starting. Do not lean over a battery.

 **WARNING**

During the charging process, a battery produces hydrogen gas. If a short circuit occurs or sparks are created, the hydrogen gas can ignite. There is a risk of an explosion.

- Make sure that the positive terminal of a connected battery does not come into contact with vehicle parts.
- Never place metal objects or tools on a battery.
- It is important that you observe the described order of the battery terminals when connecting and disconnecting a battery.
- When jump-starting, make sure that the battery poles with identical polarity are connected.
- It is particularly important to observe the described order when connecting and disconnecting the jumper cables.
- Never connect or disconnect the battery terminals while the engine is running.

 **WARNING**

A discharged battery can freeze at temperatures below freezing point. When jump-starting the vehicle or charging the battery, gases can escape from the battery. There is a risk of an explosion.

Allow the frozen battery to thaw out before charging it or jump-starting.

- !** Avoid repeated and lengthy starting attempts. Otherwise, the catalytic converter could be damaged by the non-combusted fuel.

If the indicator/warning lamps do not light up at low temperatures, it is very likely that the discharged battery has frozen. In this case, you may neither charge the battery nor jump-start the vehicle. The service life of a thawed-out battery may be shorter. The starting characteristics can be impaired, particularly at low temperatures. Have the thawed-out battery checked at a qualified specialist workshop.

Do not start the vehicle using a rapid charging device. If your vehicle's battery is discharged, the engine can be jump-started from another vehicle or from a donor battery using jumper cables. Observe the following points:

- The battery is not accessible in all vehicles. If the other vehicle's battery is not accessible, jump-start the vehicle using a donor battery or a jump-starting device.
- You may only jump-start the vehicle when the engine and exhaust system are cold.
- Do not start the engine if the battery is frozen. Let the battery thaw first.
- Only jump-start from batteries with a 12 V voltage rating.
- Only use jumper cables which have a sufficient cross-section and insulated terminal clamps.
- If the battery is fully discharged, leave the battery that is being used to jump-start connected for a few minutes before attempting to start. This charges the battery slightly.
- Make sure that the two vehicles do not touch.

Make sure that:

- The jumper cables are not damaged.
  - Bare parts of the terminal clamp do not come into contact with other metal parts while the jumper cables are connected to the battery.
  - The jumper cables cannot come into contact with parts which can move when the engine is running, such as the V-belt pulley or the fan.
- ▶ Secure the vehicle by applying the electric parking brake.
- ▶ Shift the transmission to position **P**.
- ▶ Make sure that the ignition is switched off. All indicator lamps in the instrument cluster must be off. When using the SmartKey, turn the SmartKey to position **0** in the ignition lock and remove it (▷ page 126).
- ▶ Switch off all electrical consumers, e.g. rear window defroster, lighting, etc.
- ▶ Open the hood.

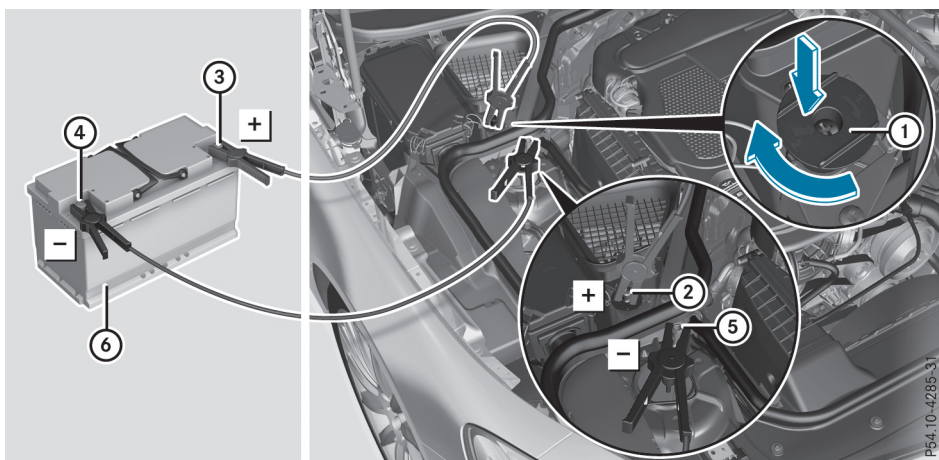

Position number ⑥ identifies the charged battery of the other vehicle or an equivalent jump-starting device.

- ▶ Press cover ① of positive terminal ② down (in the direction of the arrow) and turn it clockwise. To expose positive terminal ②, press cover ① down further.
- ▶ Connect positive terminal ② on your vehicle to positive terminal ③ of donor battery ⑥ using the jumper cable, always begin with positive terminal ② on your own vehicle first.
- ▶ Start the engine of the donor vehicle and run it at idling speed.
- ▶ Connect negative terminal ④ of donor battery ⑥ to ground point ⑤ of your vehicle using the jumper cable, beginning with donor battery ⑥ first.
- ▶ Start the engine.
- ▶ Before disconnecting the jumper cables, let the engine run for several minutes.
- ▶ First, remove the jumper cables from ground point ⑤ and negative terminal ④, then from positive terminal ② and positive terminal ③. Begin each time at the contacts on your own vehicle first.
- ▶ After the jumper cable is removed, return cover ① of positive terminal ② to the original position. Positive terminal ② is covered up and thus insulated again.
- ▶ Have the battery checked at a qualified specialist workshop.

Jump-starting is not considered to be a normal operating condition.

- i** Jumper cables and further information regarding jump-starting can be obtained at any qualified specialist workshop.

## Towing and tow-starting

### Important safety notes

#### WARNING

When towing or tow-starting another vehicle and its weight is greater than the permissible gross weight of your vehicle, the:

- the towing eye could detach itself
- the vehicle/trailer combination could roll-over.

There is a risk of an accident.

When towing or tow-starting another vehicle, its weight should not be greater than the permissible gross weight of your vehicle.

Details on the permissible gross vehicle weight of your vehicle can be found on the vehicle identification plate (▷ page 320).

- !** When Active Brake Assist, Active Distance Assist DISTRONIC or the HOLD function is activated, the vehicle brakes automatically in certain situations.

To avoid damage to the vehicle, deactivate these systems in the following or similar situations:

- when towing the vehicle
- in the car wash

- !** Only secure the tow rope or tow bar at the towing eyes. Otherwise, the vehicle could be damaged.

- !** Do not use the towing eye for recovery, this could damage the vehicle. If in doubt, recover the vehicle with a crane.

- !** When towing, pull away slowly and smoothly. If the tractive power is too high, the vehicles could be damaged.

- !** Do not tow with sling-type equipment. This could damage the vehicle.

- !** When towing away vehicles with KEYLESS-GO, use the key instead of the Start/Stop button. The automatic transmission may otherwise shift to position **P** when you

open the driver's or front-passenger door, which could damage the transmission.

- !** Make sure that the electric parking brake is released. If the electric parking brake is faulty, visit a qualified specialist workshop.

- !** You may tow the vehicle for a maximum distance of 30 miles (50 kilometers). A towing speed of 30 mph (50 km/h) must not be exceeded.

For towing distances over 30 miles (50 kilometers), the entire vehicle must be raised and transported.

- !** When you are tow-starting or towing another vehicle, its weight must not exceed the maximum permissible gross weight of your vehicle.

It is better to have the vehicle transported than to have it towed away.

The automatic transmission must be in position **N** when the vehicle is being towed away.

The battery must be connected and charged. Otherwise, you:

- cannot turn the SmartKey to position **2** in the ignition lock
- cannot shift the automatic transmission to position **N**

Deactivate the automatic locking feature before the vehicle is towed (▷ page 201). You could otherwise be locked out when pushing or towing the vehicle.

### Installing/removing the towing eye

#### Installing the towing eye

#### WARNING

The exhaust tail pipe may be very hot. There is a risk of burns when removing the rear cover.

Do not touch the exhaust pipe. Take particular care when removing the rear cover.

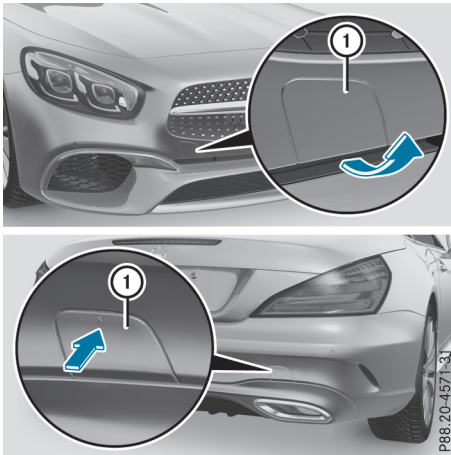

The brackets for the screw-in towing eye are located in the bumpers. They are at the front and at the rear, behind the covers.

- ▶ Remove the towing eye from the vehicle tool kit (▷ page 277).
- ▶ **Front bumper:** insert a finger into the recess on the bottom edge of cover ①.
- ▶ Pull cover ① out of the bumper towards you in the direction of the arrow.  
Cover ① is attached to the opening with a strap.
- ▶ **Rear bumper:** press the mark on cover ① inwards in the direction of the arrow.
- ▶ Remove cover ① from the opening.
- ▶ Screw in the towing eye clockwise as far as it will go and tighten it.

### Removing the towing eye

- ▶ Unscrew and remove the towing eye.
- ▶ **Front bumper:** position cover ① on the opening in the bumper.
- ▶ To close, press the lower section of cover ①.
- ▶ **Rear bumper:** position cover ① with the tab on the opening in the bumper.
- ▶ To close, press the lower section of cover ① until it engages.
- ▶ Place the towing eye in the vehicle tool kit.

### Towing a vehicle with both axles on the ground

#### ⚠ WARNING

You can no longer steer the vehicle if the steering wheel lock has been engaged.

There is a risk of an accident.

Always switch off the ignition when towing the vehicle with a tow cable or a tow bar.

The automatic transmission shifts to position **P** automatically when you open the driver's or front-passenger door or when you remove the SmartKey from the ignition lock.

In order to ensure that the automatic transmission stays in position **N** when towing away the vehicle, you must observe the following points:

- ▶ Switch on the hazard warning lamps (▷ page 111).
- ▶ Make sure that the vehicle is stationary and that the SmartKey is in position **0** in the ignition lock.
- ▶ Turn the SmartKey to position **2** in the ignition lock.  
On vehicles with KEYLESS-GO, use the SmartKey instead of the Start/Stop button (▷ page 126).
- ▶ Depress and hold the brake pedal.
- ▶ Shift the transmission to position **N**.
- ▶ Release the brake pedal.
- ▶ Release the electric parking brake.
- ▶ Leave the SmartKey in position **2** in the ignition lock.

In order to signal a change of direction when towing the vehicle with the hazard warning lamps switched on, use the combination switch as usual. In this case, only the indicator lamps for the direction of travel flash. When you reset the combination switch, the hazard warning flashers start flashing again.

It is important that you observe the safety instructions when towing away your vehicle (▷ page 288).

### Permitted towing methods

Mercedes-Benz recommends transporting your vehicle in the case of a breakdown, rather than towing it away.

When towing away, use a towing rope or a towing bar with both axles on the ground. Do not use any tow bar systems.

### Towing the vehicle with the rear axle raised

- ❗ The ignition must be switched off if you are towing the vehicle with the rear axle raised. Intervention by ESP® could otherwise damage the brake system.
- ❗ Vehicles with automatic transmission must not be towed with the rear axle raised. The vehicle/trailer combination may otherwise swerve or even roll over.

### Transporting the vehicle

#### Vehicles with automatic transmission

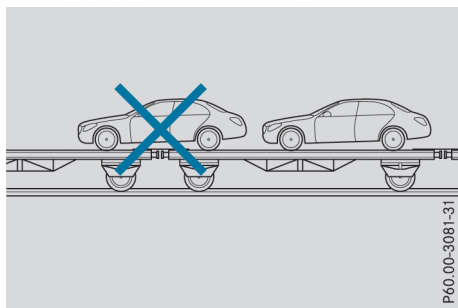

- ❗ When the vehicle is loaded for transport, the front and rear axles must be stationary and on the same transportation vehicle. Positioning over the connection point of the transport vehicle is not permitted. The drive train may otherwise be damaged.

#### All vehicles

- ❗ You may only secure the vehicle by the wheels, not by parts of the vehicle such as axle or steering components. Otherwise, the vehicle could be damaged.

The towing eye can be used to pull the vehicle onto a trailer or transporter for transporting purposes.

- ▶ Turn the SmartKey to position **2** in the ignition lock.
- ▶ Shift the transmission to position **N**.

#### As soon as the vehicle has been loaded:

- ▶ Prevent the vehicle from rolling away by applying the electric parking brake.
- ▶ Shift the transmission to position **P**.
- ▶ Turn the SmartKey to position **0** in the ignition lock and remove it.
- ▶ Secure the vehicle.

### Tow-starting (emergency engine starting)

- ❗ Vehicles with automatic transmission must not be tow-started. You could otherwise damage the automatic transmission.

You can find information on "Jump-starting" at (> page 285).

## Fuses

### Important safety notes

#### ⚠ WARNING

If you manipulate or bridge a faulty fuse or if you replace it with a fuse with a higher amperage, the electric cables could be overloaded. This could result in a fire. There is a risk of an accident and injury.

Always replace faulty fuses with the specified new fuses having the correct amperage.

Blown fuses must be replaced with fuses of the same rating, which you can recognize by the color and value. The fuse ratings are listed in the fuse allocation chart.

The fuse allocation chart is located in the vehicle tool kit in the stowage compartment under the trunk floor (> page 277).

If a newly inserted fuse also blows, have the cause traced and rectified at a qualified specialist workshop, e.g. an authorized Mercedes-Benz Center.

- ❗ Only use fuses that have been approved for Mercedes-Benz vehicles and which have the correct fuse rating for the system con-

cerned. Otherwise, components or systems could be damaged.

- ❗ Make sure that no moisture can enter the fuse box when the cover is open.
- ❗ When closing the cover, make sure that it is lying correctly on the fuse box. Moisture seeping in or dirt could otherwise impair the operation of the fuses.

The fuses in your vehicle serve to close down faulty circuits. If a fuse blows, all the components on the circuit and their functions stop operating.

### Before changing a fuse

- ▶ Switch off the engine.
- ▶ Switch off all electrical consumers.
- ▶ Make sure that the ignition is switched off (▷ page 126).

or

- ▶ When using the SmartKey, turn the SmartKey to position **0** in the ignition lock and remove it (▷ page 126).
- ▶ Secure the vehicle against rolling away (▷ page 146).

All indicator lamps in the instrument cluster must be off.

The fuses are located in various fuse boxes:

- Fuse box in the engine compartment on the right-hand side of the vehicle, when viewed in the direction of travel
- Dashboard fuse box
- Fuse box in the rear compartment on the right-hand side of the vehicle, when viewed in the direction of travel

### Dashboard fuse box

- ❗ Observe the "Important safety notes" section (▷ page 290).

- ❗ Do not use a pointed object such as a screwdriver to open the cover in the dashboard. You could damage the dashboard or the cover.

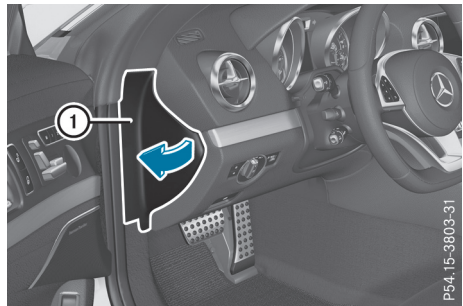

- ▶ Open the driver's door.
- ▶ **To open:** pull cover ① outwards in the direction of the arrow and remove it.
- ▶ **To close:** clip in cover ① on the front of the dashboard.
- ▶ Fold cover ① inwards until it engages.

### Fuse box in the engine compartment

- ❗ Observe the "Important safety notes" section (▷ page 290).

#### ⚠ WARNING

When the hood is open and the windshield wipers are set in motion, you can be injured by the wiper linkage. There is a risk of injury. Always switch off the windshield wipers and the ignition before opening the hood.

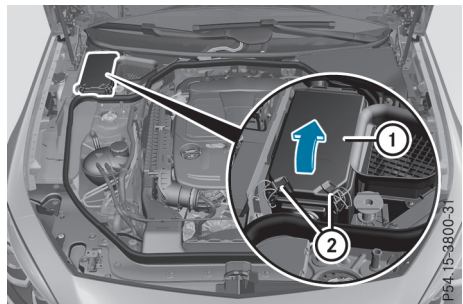

- ▶ Open the hood.
- ▶ Use a dry cloth to remove any moisture from the fuse box.
- ▶ **To open:** open clamps ②.
- ▶ Fold cover ① of the fuse box up in the direction of the arrow and remove it.



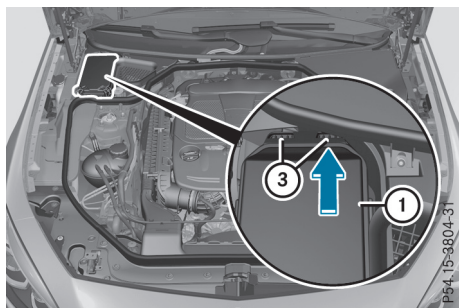

- ▶ **To close:** check whether the seal is seated correctly in cover ①.
- ▶ Insert both openings ③ at the rear of cover ① into the brackets on the fuse box. The brackets on the fuse box must be completely visible in the two openings ③ on the fuse box.
- ▶ Fold down cover ①.
- ▶ Hook clamps ② into the fuse box and close.
- ▶ Close the hood.

### Fuse box in the rear passenger compartment

- ❗ Observe the "Important safety notes" section (▷ page 290).

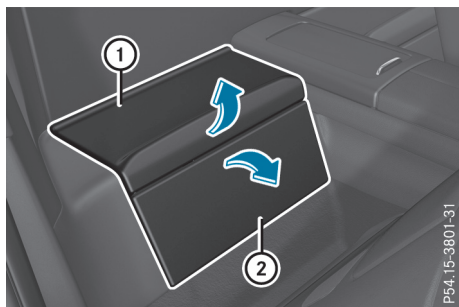

The fuse box in the rear is located on the right-hand side when viewed in the direction of travel.

- ▶ **To open:** open the seat belt guide on the right-hand seat and remove the seat belt (▷ page 99).
- ▶ Move the right-hand seat as far forward as possible (▷ page 100).

- ▶ Insert your fingers at the bottom of front cover ② between the cover and floor covering.
- ▶ Remove front cover ② by pulling it forward in the direction of the arrow.
- ▶ Lift off top cover ① by pulling it in the direction of the arrow.

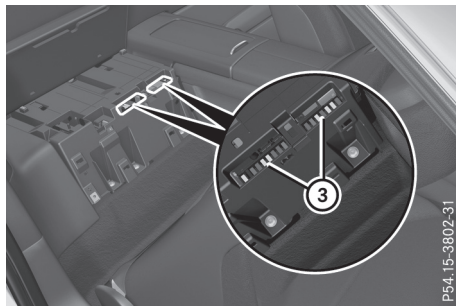

Fuses ③ are accessible through the two openings in the top of the fuse box.

- ▶ **To close:** insert the securing tags underneath top cover ① in the recesses at the top of the fuse box.
- ▶ Fold down top cover ① until it engages audibly.
- ▶ Insert the securing tags underneath top cover ② in the recesses at the front of the fuse box.
- ▶ Push front cover ② towards the rear until it engages audibly.
- ▶ Move the right-hand seat backwards (▷ page 100).
- ▶ Hook the seat belt into the seat belt guide on the right-hand seat (▷ page 99).



**Important safety notes**

**⚠ WARNING**

If you install wheels and tires with incorrect dimensions, the service brake or wheel suspension components may be damaged. There is a risk of an accident.

Always replace wheels and tires with ones that comply with the specifications of the original part.

When replacing wheels, pay attention to the:

- Designation
- Model

When replacing tires, pay attention to the:

- Designation
- Manufacturer
- Model

**⚠ WARNING**

A flat tire will severely affect the driving characteristics as well as the steering and braking of the vehicle. There is a risk of an accident.

Tires without run-flat characteristics:

- Do not drive on with a flat tire.
- Change the flat tire immediately with an emergency spare wheel or spare wheel. Alternatively, consult a qualified specialist workshop.

Tires with run-flat characteristics:

- Observe the information and warning notes on MOExtended tires (run-flat tires).

Accessories that are not approved for your vehicle by Mercedes-Benz or are not being used correctly can impair the operating safety. Before purchasing and using non-approved accessories, visit a qualified specialist workshop and ask about:

- suitability
- legal stipulations
- factory recommendations

Further information regarding wheels and tires can be found under "Wheel/tire combinations" (▷ page 318).

You can ask for information regarding permitted wheel/tire combinations at an authorized Mercedes-Benz Center.

Information on tire pressure can be found:

- on the Tire and Loading Information placard on the B-pillar on the driver's side (▷ page 303)
- in the tire pressure table in the fuel filler flap (▷ page 145)
- in the "Tire pressure" section

**Operation**

**Information on driving**

Check the tire pressure when the vehicle is heavily laden and adjust prior to a trip.

While driving, pay attention to vibrations, noises and unusual handling characteristics, e.g. pulling to one side. This may indicate that the wheels or tires are damaged. If you suspect that a tire is defective, reduce your speed immediately. Stop the vehicle as soon as possible to check the wheels and tires for damage. Hidden tire damage could also be causing the unusual handling characteristics. If you find no signs of damage, have the tires and wheels checked at a qualified specialist workshop.

When parking your vehicle, make sure that the tires do not get deformed by the curb or other obstacles. If they cannot be avoided, drive over obstacles such as curbs slowly and at an obtuse angle. Otherwise, you may damage the wheels or tires.

**Regular checking of wheels and tires**

**⚠ WARNING**

Damaged tires can cause tire inflation pressure loss. As a result, you could lose control of your vehicle. There is a risk of accident.

Check the tires regularly for signs of damage and replace any damaged tires immediately.

Check wheels and tires for damage at least once a month. Check wheels and tires after driving off-road or on rough roads. Damaged wheels can cause a loss of tire pressure. Pay particular attention to damage such as:

- cuts in the tires
- punctures in the tires
- tears in the tires
- bulges on tires
- deformation or severe corrosion on wheels

Regularly check the tire tread depth and the condition of the tread across the whole width of all tires (> page 294). If necessary, turn the front wheels to full lock in order to inspect the inner side of the tire surface.

All wheels must have a valve cap to protect the valve against dirt and moisture. Do not mount anything onto the valve other than the standard valve cap or other valve caps approved by Mercedes-Benz for your vehicle. Do not use any other valve caps or systems, e.g. tire pressure monitoring systems.

Regularly check the pressure of all the tires particularly prior to long trips. Adjust the tire pressure as necessary (> page 296).

The service life of tires depends, among other things, on the following factors:

- Driving style
- Tire pressure
- Distance covered

### Notes on tire tread

#### WARNING

If there is insufficient tire tread, the tire traction decreases. The tire tread is no longer able to dissipate water. This increases the risk of hydroplaning when the road surface is wet, particularly when the vehicle's speed is not adapted to the road conditions. There is a risk of an accident.

When the tire pressure is too high or too low, tires may wear differently at different points on the tire tread. Therefore, regularly check the tire tread depth and the condition of the tread across the whole width of all tires.

Minimum tire tread depth on:

- Summer tires:  $\frac{1}{8}$  in (3 mm)
- M+S tires:  $\frac{1}{4}$  in (4 mm)

For safety reasons, have the tires replaced before they reach the legally prescribed minimum tire tread depth.

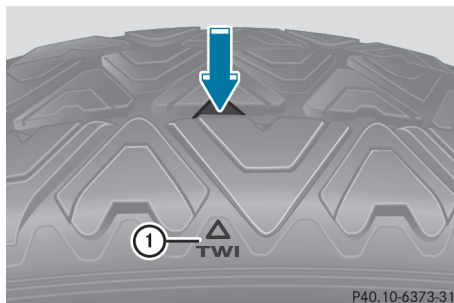

Marking ① shows where the bar indicator for tread wear (arrow) is integrated into the tire tread.

Treadwear indicators (TWI) are required by law. Six indicators are positioned on the tire tread. They are visible once a tread depth of approximately  $\frac{1}{16}$  in (1.6 mm) has been reached. If this is the case, the tire is so worn that it must be replaced.

### Selecting, mounting and replacing tires

Tires and wheels

- Only mount tires and wheels of the same type and make.  
Exception: it is permissible to mount a different type or make in the event of a flat tire. Observe the "MOExtended tires (tires with run-flat characteristics)" section (> page 278).
- Only mount tires of the correct size onto the wheels.
- Break in new tires at moderate speeds for the first 60 miles (100 km). The new tires only reach their full performance after this distance.

- Do not drive with tires which have too little tread depth. This significantly reduces the traction on wet roads (hydroplaning).
- Replace the tires after six years at the latest, regardless of wear.

### MOExtended tires (tires with run-flat properties)

With MOExtended tires (tires with run flat characteristics), you can continue to drive your vehicle even if there is a total loss of pressure in one or more tires.

MOExtended tires may only be used in conjunction with an active tire pressure monitor and only on wheels specifically tested by Mercedes-Benz.

Notes on driving with MOExtended tires with a flat tire (▷ page 278).

Vehicles equipped with MOExtended tires are not equipped with a TIREFIT kit at the factory. It is therefore recommended that you additionally equip your vehicle with a TIREFIT kit if you mount tires that do not feature run-flat characteristics, e.g. winter tires. A TIREFIT kit can be obtained from a qualified specialist workshop.

## Winter operation

### General notes

Have your vehicle winter-proofed at a qualified specialist workshop at the onset of winter.

Observe the notes in the "Changing a wheel" section (▷ page 313).

### Driving with summer tires

At temperatures below 45 °F (+7 °C), summer tires lose elasticity and therefore traction and braking power. Change the tires on your vehicle to M+S tires. Using summer tires at very cold temperatures could cause cracks to form, thereby damaging the tires permanently. Mercedes-Benz cannot accept responsibility for this type of damage.

#### WARNING

Damaged tires can cause tire inflation pressure loss. As a result, you could lose control of your vehicle. There is a risk of accident.

Check the tires regularly for signs of damage and replace any damaged tires immediately.

### M+S tires

#### WARNING

M+S tires with a tire tread depth of less than 1/8 in (4 mm) are not suitable for use in winter and do not provide sufficient traction. There is a risk of an accident.

M+S tires with a tread depth of less than 1/8 in (4 mm) must be replaced immediately.

At temperatures below 45 °F (+7 °C), use winter tires or all-season tires. Both types of tire are identified by the M+S marking.

Only winter tires bearing the  snowflake symbol in addition to the M+S marking provide the best possible grip in wintry road conditions.

Only these tires will allow driving safety systems such as ABS and ESP® to function optimally in winter. These tires have been developed specifically for driving in snow.

Use M+S tires of the same make and tread on all wheels to maintain safe handling characteristics.

Always observe the maximum permissible speed specified for the M+S tires you have mounted.

When you have mounted the M+S tires:

- ▶ Check the tire pressures (▷ page 299).
- ▶ Restart the tire pressure monitor (▷ page 301).

### Snow chains

#### WARNING

If snow chains are installed to the front wheels, they may drag against the vehicle body or chassis components. This could cause damage to the vehicle or the tires. There is a risk of an accident.

To avoid hazardous situations:

- never install snow chains to the front wheels
- always install snow chains in pairs to the rear wheels.

For safety reasons, Mercedes-Benz recommends that you only use snow chains that have been specially approved for your vehicle by Mercedes-Benz, or are of a corresponding standard of quality. For more information, please contact a qualified specialist workshop. If you intend to mount snow chains, please bear the following points in mind:

- Snow chains may not be mounted on all wheel/tire combinations. Permissible wheel-tire combinations (▷ page 318).
- Only use snow chains when driving on roads completely covered by snow. Remove the snow chains as soon as possible when you come to a road that is not snow-covered.
- Local regulations may restrict the use of snow chains. Observe the appropriate regulations if you wish to mount snow chains.
- Do not exceed the maximum permissible speed of 30 mph (50 km/h).
- On vehicles with Active Body Control (ABC), if snow chains have been installed, you must drive at a raised vehicle level (▷ page 168).

You may wish to deactivate ESP® when pulling away with snow chains installed (▷ page 66). You can thereby allow the wheels to spin in a controlled manner, achieving an increased driving force (cutting action).

## Tire pressure

### Tire pressure specifications

#### Important safety notes

##### WARNING

Underinflated or overinflated tires pose the following risks:

- the tires may burst, especially as the load and vehicle speed increase.
- the tires may wear excessively and/or unevenly, which may greatly impair tire traction.
- the driving characteristics, as well as steering and braking, may be greatly impaired.

There is a risk of an accident.

Follow recommended tire inflation pressures and check the pressure of all the tires including the spare wheel:

- monthly, at least
- if the load changes
- before beginning a long journey
- under different operating conditions, e.g. off-road driving

If necessary, correct the tire pressure.

The data on the Tire and Loading Information placard and tire pressure table shown here are examples. Tire pressure specifications are vehicle-specific and may deviate from the data shown here. The tire pressure specifications that are valid for your vehicle can be found on the Tire and Loading Information placard and tire pressure table on the vehicle.

#### General notes

The recommended tire pressures for the tires mounted at the factory can be found on the labels described here.

Further information on tire pressures can be obtained at a qualified specialist workshop.

## Tire and Loading Information placard

**TIRE RENSEIGNEMENT SUR LES PNEUS ET LE CHARGEMENT**

SEATING CAPACITY / NOMBRE DE PLACES TO GO should never exceed / ne doit jamais dépasser

TIRE PNEU	SIZE DIMENSIONS	COLD TIRE PRESSURE / PRESSION DES PNEUS À FROID
FRONT AVANT	255/40 ZR18 99Y XL	200 KPA, 29 PSI
REAR ARRIÈRE	285/35 ZR18 101Y XL	200 KPA, 29 PSI
SPARE DE SECOURS	175/55-18 95P	420 KPA, 60 PSI

SEE OWNER'S MANUAL FOR ADDITIONAL INFORMATION / VOIR LE MANUEL DE L'USAGER POUR PLUS DE RENSEIGNEMENTS

P40.00-2223-31

### ① Recommended tire pressures

The Tire and Loading Information placard is on the B-pillar on the driver's side (▷ page 303). The Tire and Loading Information placard contains the recommended tire pressures for cold tires. The recommended tire pressures are valid for the maximum permissible load and up to the maximum permissible vehicle speed.

## Tire pressure table

The tire pressure table is on the inside of the fuel filler flap. It shows the tire pressure for all tires permitted at the factory for this vehicle; see illustration (example).

**COLD TIRE PRESSURE**

normal load

maximum load

Warm tires up to: + 4 psi

A 2.12.534-00.15

1234567

P40.00-2229-31

The tire pressure table contains the recommended pressures for cold tires for various operating conditions, i.e. differing load and speed conditions.

If a tire size precedes a tire pressure, the following tire pressure information is only valid for that tire size; see illustration (example).

**LUFTDRUCK PRESSURE PRESSION PRESIÓN**

für kalte Reifen / for cold tires / des pneus froids / de Infiado

100 kPa = 1 bar

Tire Size	kPa	psi	kPa	psi
195/55 R16				
215/45 R17				
215/40 R18				

Warme Reifen: Warm tires up to: + 30 kPa / + 4 psi

Pneus échauffés jusqu'à: Neumáticos calientes hasta:

A 169-584-60.17

P40.00-2228-31

The load conditions "partially laden" and "fully laden" are defined in the table for different numbers of occupants and amounts of luggage. The actual number of seats may differ.

Luftdruck für kalte Reifen / Tire pressure cold tires / Pression des pneus froids / Presión de Infiado

100 kPa = 1 bar

Rim Diameter	kPa	psi	kPa	psi
R18				
R19				

bis up to / jusqu'à / Winterreifen: Winter tires: Pressione Inverno: Neumáticos de invierno: + 30 kPa / + 4 psi

Warme Reifen bis: Warm tires up to: + 30 kPa / + 4 psi

Pneus échauffés jusqu'à: Neumáticos calientes hasta:

A 2.12.534-02.17

P40.00-2230-31

Some tire pressure tables show only the rim diameters instead of the full tire size, e.g. **R18**. Rim diameter is part of the tire size and can be found on the tire sidewall (▷ page 307). If the tire pressures have been set to the lower values for lighter loads and/or lower road speeds, the pressures should be reset to the higher values:

- if you want to drive with an increased load and/or
- if you want to drive at higher road speeds

The tire pressures for increased loads and/or higher road speeds, shown in the tire pressure table, may have a negative effect on driving comfort.

If the tire pressure is not set correctly, this can lead to an excessive build-up of heat and a sudden loss of pressure.

For more information, contact a qualified specialist workshop.

### Important notes on tire pressure

#### WARNING

If the tire pressure drops repeatedly, the wheel, valve or tire may be damaged. Tire pressure that is too low may result in a tire blow-out. There is a risk of an accident.

- Check the tire for foreign objects.
- Check whether the wheel is losing air or the valve is leaking.

If you are unable to rectify the damage, contact a qualified specialist workshop.

#### WARNING

If you fit unsuitable accessories onto tire valves, the tire valves may be overloaded and malfunction, which can cause tire pressure loss. Due to their design, retrofitted tire pressure monitors keep the tire valve open. This can also result in tire pressure loss. There is a risk of an accident.

Only screw the standard valve cap or other valve caps approved by Mercedes-Benz for your vehicle onto the tire valve.

Use a suitable pressure gauge to check the tire pressure. The outer appearance of a tire does not permit any reliable conclusion about the tire pressure. On vehicles equipped with the electronic tire pressure monitor, the tire pressure can be checked in the on-board computer.

The tire temperature and pressure increase when the vehicle is in motion. This is dependent on the driving speed and the load.

Therefore, you should only correct tire pressures when the tires are cold.

The tires are cold:

- if the vehicle has been parked with the tires out of direct sunlight for at least three hours and
- if the vehicle has not been driven further than 1 mile (1.6 km)

The tire temperature changes depending on the outside temperature, the vehicle speed and the tire load. If the tire temperature changes by 18 °F (10 °C), the tire pressure changes by approximately 10 kPa (0.1 bar/1.5 psi). Take this into account when checking

the pressure of warm tires. Only correct the tire pressure if it is too low for the current operating conditions. If you check the tire pressure when the tires are warm, the resulting value will be higher than if the tires were cold. This is normal. Do not reduce the tire pressure to the value specified for cold tires. The tire pressure would otherwise be too low. Observe the recommended tire pressures for cold tires:

- on the Tire and Loading Information placard on the B-pillar on the driver's side
- in the tire pressure table on the inside of the fuel filler flap

### Underinflated or overinflated tires

#### Underinflated tires

#### WARNING

Tires with pressure that is too low can overheat and burst as a consequence. In addition, they also suffer from excessive and/or irregular wear, which can severely impair the braking properties and the driving characteristics. There is a risk of an accident.

Avoid tire pressures that are too low in all the tires, including the spare wheel.

Underinflated tires may:

- overheat, leading to tire defects
- adversely affect handling
- wear excessively and/or unevenly
- have an adverse effect on fuel consumption

#### Overinflated tires

#### WARNING

Tires with excessively high pressure can burst because they are damaged more easily by road debris, potholes etc. In addition, they also suffer from irregular wear, which can severely impair the braking properties and the driving characteristics. There is a risk of an accident.

Avoid tire pressures that are too high in all the tires, including the spare wheel.

Overinflated tires may:

- increase the braking distance
- adversely affect handling
- wear excessively and/or unevenly
- have an adverse effect on ride comfort
- be more susceptible to damage

## Maximum tire pressures

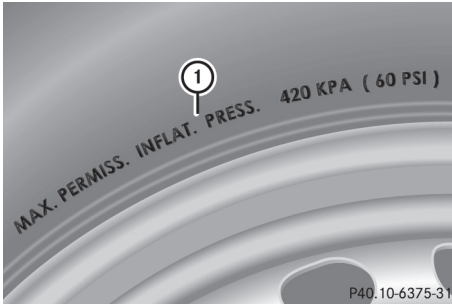

① Example: maximum permissible tire pressure

Never exceed the maximum permissible tire inflation pressure. Always observe the recommended tire pressure for your vehicle when adjusting the tire pressure (▷ page 296).

**i** The actual values for tires are vehicle-specific and may deviate from the values in the illustration.

## Checking the tire pressures

### Important safety notes

The tire pressure monitor does not warn you of:

- incorrectly set tire pressure
- sudden loss of tire pressure, e.g. from a foreign object that has penetrated the tire

Observe the notes on tire pressure (▷ page 296).

Information on air pressure for the tires on your vehicle can be found:

- on the vehicle's Tire and Loading Information placard on the B-pillar
- on the tire pressure table in the fuel filler flap
- in the "Tire pressure" section

## Checking tire pressures manually

To determine and set the correct tire pressure, proceed as follows:

- ▶ Remove the valve cap of the tire that is to be checked.
- ▶ Press the tire pressure gauge securely onto the valve.
- ▶ Read the tire pressure and compare it to the recommended value on the Tire and Loading Information placard or the tire pressure table (▷ page 296).
- ▶ If the tire pressure is too low, increase the tire pressure to the recommended value.
- ▶ If the tire pressure is too high, release air. To do so, press down the metal pin in the valve, using the tip of a pen for example. Then check the tire pressure again using the tire pressure checker.
- ▶ Screw the valve cap onto the valve.
- ▶ Repeat these steps for the other tires.

## Tire pressure monitor

### General notes

If a tire pressure monitor is installed, the vehicle's wheels have sensors that monitor the tire pressures in all four tires. The tire pressure monitor warns you if the pressure drops in one or more of the tires. The tire pressure monitor only functions if the corresponding sensors are installed in all wheels.

Information on tire pressures is displayed in the multifunction display. After a few minutes of driving, the current tire pressure of each tire is shown in the **Serv.** menu of the multifunction display.

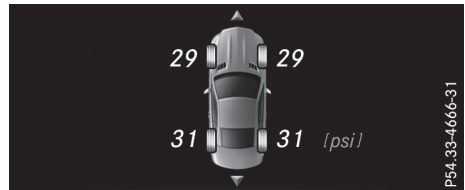

Example: current tire pressure display

For information on the message display, refer to the "Checking the tire pressure electronically" section (▷ page 301).



## Important safety notes

### WARNING

Each tire, including the spare (if provided), should be checked at least once a month when cold and inflated to the pressure recommended by the vehicle manufacturer on the Tire and Loading Information placard on the driver's door B-pillar or the tire pressure label on the inside of the fuel filler flap. If your vehicle has tires of a different size than the size indicated on the Tire and Loading Information placard or the tire pressure label, you should determine the proper tire pressure for those tires.

As an added safety feature, your vehicle has been equipped with a tire pressure monitoring system (TPMS) that illuminates a low tire pressure telltale when one or more of your tires are significantly underinflated. Accordingly, when the low tire pressure telltale illuminates, you should stop and check your tires as soon as possible, and inflate them to the proper pressure. Driving on a significantly underinflated tire causes the tire to overheat and can lead to tire failure. Underinflation also reduces fuel efficiency and tire tread life, and may affect the vehicle's handling and stopping ability.

Please note that the TPMS is not a substitute for proper tire maintenance, and it is the driver's responsibility to maintain correct tire pressure, even if underinflation has not reached the level to trigger illumination of the TPMS low tire pressure telltale.

USA only:

Your vehicle has also been equipped with a TPMS malfunction indicator to indicate if the system is not operating properly. The TPMS malfunction indicator is combined with the low tire pressure telltale. When the system detects a malfunction, the warning lamp will flash for approximately a minute and then remain continuously illuminated. This sequence will be repeated every time the vehicle is started as long as the malfunction exists.

When the malfunction indicator is illuminated, the system may not be able to detect or signal low tire pressure as intended. TPMS malfunctions may occur for a variety of reasons, including the mounting of incompatible replacement or alternate tires or wheels on the vehicle that prevent the TPMS from functioning properly. Always check the TPMS malfunction telltale after replacing one or more tires or wheels on your vehicle to ensure that the replacement or alternate tires and wheels allow the TPMS to continue to function properly.

It is the driver's responsibility to set the tire pressure to that recommended for cold tires which is suitable for the operating situation (> page 296). Note that the correct tire pressure for the current operating situation must first be taught-in to the tire pressure monitor. If a substantial loss of pressure occurs, the warning threshold for the warning message is aligned to the taught-in reference values. Restart the tire pressure monitor after adjusting the pressure of the cold tires (> page 301). The current pressures are saved as new reference values. As a result, a warning message will appear if the tire pressure drops significantly.

The tire pressure monitor does not warn you of an incorrectly set tire pressure. Observe the notes on the recommended tire pressure (> page 296).

The tire pressure monitor is not able to warn you of a sudden loss of pressure, e.g. if the tire is penetrated by a foreign object. In the event of a sudden loss of pressure, bring the vehicle to a halt by braking carefully. Avoid abrupt steering movements.

The tire pressure monitor has a yellow warning lamp in the instrument cluster for indicating pressure loss or a malfunction. Whether the warning lamp flashes or lights up indicates whether a tire pressure is too low or the tire pressure monitor is malfunctioning:

- if the warning lamp is lit continuously, the tire pressure on one or more tires is significantly too low. The tire pressure monitor is not malfunctioning.
- if the warning lamp flashes for approximately a minute and then remains lit con-

stantly, the tire pressure monitor is malfunctioning.







In addition to the warning lamp, a message appears in the multifunction display. Observe the information on display messages (▷ page 227).

It may take up to ten minutes for a malfunction of the tire pressure monitor to be indicated. A malfunction will be indicated by the tire pressure warning lamp flashing for approximately one minute and then remaining lit. When the malfunction has been rectified, the tire pressure warning lamp goes out after a few minutes of driving.

The tire pressure values indicated by the on-board computer may differ from those measured at a gas station with a pressure gage. The tire pressures shown by the on-board computer refer to those measured at sea level. At high altitudes, the tire pressure values indicated by a pressure gage are higher than those shown by the on-board computer. In this case, do not reduce the tire pressures.

The operation of the tire pressure monitor can be affected by interference from radio transmitting equipment (e.g. radio headphones, two-way radios) that may be being operated in or near the vehicle.

### Checking the tire pressure electronically

- ▶ Make sure that the SmartKey is in position  (▷ page 126) in the ignition lock.
  - ▶ Press the  or  button on the steering wheel to select the **Serv.** menu.
  - ▶ Press the  or  button to select **Tire Pressure**.
  - ▶ Press .
- The current tire pressure of each tire is shown in the multifunction display.

If the vehicle has been parked for over 20 minutes, the **Tire pressure will be displayed after driving a few minutes** message appears.

After a teach-in process, the tire pressure monitor automatically detects new wheels or new sensors. As long as a clear allocation of the tire pressure value to the individual wheels is not possible, the **Tire Pressure Monitor Active** display message is shown instead of the tire pressure display. The tire pressures are already being monitored.

### Tire pressure monitor warning messages

The tire pressure monitor detects a pressure loss in one or more tires:

- If the tire pressure monitor detects a pressure loss in one or more tires, a warning message is shown in the multifunction display. The yellow tire pressure warning lamp then lights up.
- If the **Please Correct Tire Pressure** message appears in the multifunction display, the tire pressure in at least one tire is too low. The tire pressure must be corrected when the opportunity arises.
- If the **Check Tires** message appears in the multifunction display, the tire pressure in at least one tire has dropped significantly. The tires must be checked.
- If the **Warning Tire Malfunction** message appears in the multifunction display, the tire pressure in at least one tire has dropped suddenly. The tires must be checked.

Observe the instructions and safety notes in the display messages in the "Tires" section (▷ page 227).

If the wheel positions on the vehicle are rotated, the tire pressures may be displayed for the wrong positions for a short time. This is rectified after a few minutes of driving, and the tire pressures are displayed for the correct positions.

### Restarting the tire pressure monitor

When you restart the tire pressure monitor, all existing warning messages are deleted and the warning lamps go out. The monitor uses the currently set tire pressures as the reference values for monitoring. In most cases, the tire pressure monitor will automatically detect the new reference values after you have changed the tire pressure. However, you can also set reference values manually as described here. The tire pressure monitor then monitors the new tire pressure values.

- ▶ Set the tire pressure to the value recommended for the corresponding driving situation on the Tire and Loading Information placard on the driver's side B-pillar (▷ page 296).

Additional tire pressure values for different loads can also be found on the tire pressure table on the inside of the fuel filler flap (> page 296).

- ▶ Make sure that the tire pressure is correct on all four wheels.
- ▶ Ensure that the SmartKey is in position **2** in the ignition lock.
- ▶ Press the **◀** or **▶** button on the steering wheel to select the **Serv.** menu.
- ▶ Press the **▲** or **▼** button to select **Tire Pressure**.
- ▶ Press **OK**.  
The multifunction display shows the current tire pressure for the individual tires or the **Tire pressure will be displayed after driving a few minutes** message.
- ▶ Press the **▼** button.  
The **Use Current Pressures as New Reference Values** message appears in the multifunction display.

#### If you wish to confirm the restart:

- ▶ Press **OK**.  
The **Tire Press. Monitor Restarted** message appears in the multifunction display.

After driving for a few minutes, the system checks whether the current tire pressures are within the specified range. The new tire pressures are then accepted as reference values and monitored.

#### If you wish to cancel the restart:

- ▶ Press **↩**.  
The tire pressure values stored at the last restart will continue to be monitored.

## Radio type approval for the tire pressure monitor

Country	Radio type approval number
USA	<p>FCC ID: MRXMW2433A</p> <p>FCCIC ID:MRXGG4 This device complies with part 15 of the FCC rules and with license exempt RSS standards of Industry Canada. Operation is subject to the following conditions. (1) This device may not cause harmful interference, and (2) This device must accept any interference received, including interference that may cause undesired operation. Le present appareil est conforme d'industrie Canada applicables aux appareils radio exempts de licence. L'exploitation est autorisee aux deux conditions suivantes. (1) L'appareil ne doit pas produire de brouillage, et (2) L'autisatuer de l'appareil doit accepter tout brouillage radioelectrique subi, meme si le brouillage est susceptible d'en compromettre le fonctionnement. WARNING: Changes or modifications not expressly approved by the party responsible for compliance could void the user's authority to operate the equipment. The term "IC:" before the radio certification number only signifies Canada technical specifications were met.</p> <p>FCC ID:MRXMC34MA4 This device complies with part 15 of the FCC rules and with license exempt RSS standards of Industry Canada. Operation is subject to the following conditions. (1) This device may not cause harmful interference, and (2) This device must accept any interference received, including interference that may cause undesired operation. Le present appareil est conforme d'industrie Canada applicables aux appareils radio exempts de</p>

Country	Radio type approval number
	licence. L'exploitation est autorisée aux deux conditions suivantes. (1) L'appareil ne doit pas produire de brouillage, et (2) L'autorisatuer de l'appareil doit accepter tout brouillage radioélectrique subi, même si le brouillage est susceptible d'en compromettre le fonctionnement. WARNING: Changes or modifications not expressly approved by the party responsible for compliance could void the user's authority to operate the equipment. The term "IC:" before the radio certification number only signifies Canada technical specifications were met.
Canada	IC: 2546A-MW2433A IC:2546A-GG4 This device complies with part 15 of the FCC rules and with license exempt RSS standards of Industry Canada. Operation is subject to the following conditions. (1) This device may not cause harmful interference, and (2) This device must accept any interference received, including interference that may cause undesired operation. Le présent appareil est conforme d'industrie Canada applicables aux appareils radio exempts de licence. L'exploitation est autorisée aux deux conditions suivantes. (1) L'appareil ne doit pas produire de brouillage, et (2) L'autorisatuer de l'appareil doit accepter tout brouillage radioélectrique subi, même si le brouillage est susceptible d'en compromettre le fonctionnement. WARNING: Changes or modifications not expressly approved by the party responsible for compliance could void the user's authority to operate the equipment. The term "IC:" before the radio certification number only signifies Canada technical specifications were met.

Country	Radio type approval number
	IC: 2546A-MC34MA4

## Loading the vehicle

### Instruction labels for tires and loads

#### WARNING

Overloaded tires can overheat, causing a blowout. Overloaded tires can also impair the steering and driving characteristics and lead to brake failure. There is a risk of accident.

Observe the load rating of the tires. The load rating must be at least half of the GAWR of your vehicle. Never overload the tires by exceeding the maximum load.

Two instruction labels on your vehicle show the maximum possible load.

- (1) The Tire and Loading Information placard is on the B-pillar on the driver's side. The Tire and Loading Information placard shows the maximum permissible number of occupants and the maximum permissible vehicle load. It also contains details of the tire sizes and corresponding pressures for tires mounted at the factory.
- (2) The vehicle identification plate is on the B-pillar on the driver's side. The vehicle identification plate informs you of the gross vehicle weight rating. It is made up of the vehicle weight, all vehicle occupants, the fuel and the cargo. You can also find information about the maximum gross axle weight rating on the front and rear axle.

The maximum gross axle weight rating is the maximum weight that can be carried by one axle (front or rear axle). Never exceed the maximum load or the maximum gross axle weight rating for the front or rear axle.

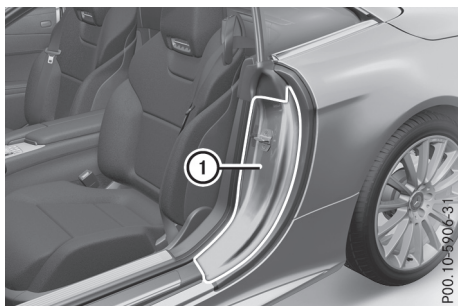

P00.10-B006-31

① B-pillar, driver's side

## Maximum permissible gross vehicle weight rating

TIRE RENSEIGNEMENTS		LOADING INFORMATION	
SUR LES PNEUS ET LE CHARGEMENT		RENGEINEMENT SUR LES PNEUS ET LE CHARGEMENT	
SEATING CAPACITY NOMBRE DE PLACES	TOTAL 7	FRONT AVANT 2	MIDDLE MILIEU 3
REAR ARRIÈRE	2		
The combined weight of occupants and cargo should never exceed XXX kg or XXX lbs. Le poids total des occupants et du chargement ne doit jamais dépasser XXX kg ou XXX lbs.*			
TIRE PNEU	SIZE DIMENSIONS	COLD TIRE PRESSURE PRESSION DES PNEUS À FROID	SEE OWNER'S MANUAL FOR ADDITIONAL INFORMATION
FRONT AVANT	255/40 ZR18 99Y XL	200 KPA, 29 PSI	VOIR LE MANUEL DE L'USAGER POUR PLUS DE RENSEIGNEMENTS
REAR ARRIÈRE	285/35 ZR18 101Y XL	200 KPA, 29 PSI	
SPARE DE SECOURS	175/55-18 95P	420 KPA, 60 PSI	

P40.00-2224-31

- Specification for maximum gross vehicle weight ① is listed in the Tire and Loading Information placard: "The combined weight of occupants and cargo should never exceed XXX kilograms or XXX lbs."

The gross weight of all vehicle occupants, load and luggage must not exceed the specified value.

- ① The specifications shown on the Tire and Loading Information placard in the illustration are examples. The maximum permissible gross vehicle weight rating is vehicle-specific and may differ from that in the illustration. You can find the valid maximum permissible gross vehicle weight rating for your vehicle on the Tire and Loading Information placard.

## Number of seats

TIRE RENSEIGNEMENTS		LOADING INFORMATION	
SUR LES PNEUS ET LE CHARGEMENT		RENGEINEMENT SUR LES PNEUS ET LE CHARGEMENT	
SEATING CAPACITY NOMBRE DE PLACES	TOTAL 7	FRONT AVANT 2	MIDDLE MILIEU 3
REAR ARRIÈRE	2		
The combined weight of occupants and cargo should never exceed XXX kg or XXX lbs. Le poids total des occupants et du chargement ne doit jamais dépasser XXX kg ou XXX lbs.*			
TIRE PNEU	SIZE DIMENSIONS	COLD TIRE PRESSURE PRESSION DES PNEUS À FROID	SEE OWNER'S MANUAL FOR ADDITIONAL INFORMATION
FRONT AVANT	255/40 ZR18 99Y XL	200 KPA, 29 PSI	VOIR LE MANUEL DE L'USAGER POUR PLUS DE RENSEIGNEMENTS
REAR ARRIÈRE	285/35 ZR18 101Y XL	200 KPA, 29 PSI	
SPARE DE SECOURS	175/55-18 95P	420 KPA, 60 PSI	

P40.00-2225-31

Maximum number of seats ① indicates the maximum number of occupants allowed to travel in the vehicle. This information can be found on the Tire and Loading Information placard.

- ① The specifications shown on the Tire and Loading Information placard in the illustration are examples. The number of seats is vehicle-specific and can differ from the details shown. The number of seats in your vehicle can be found on the Tire and Loading Information placard.

## Determining the correct load limit

### Step-by-step instructions

The following steps have been developed as required of all manufacturers under Title 49, Code of U.S. Federal Regulations, Part 575 pursuant to the "National Traffic and Motor Vehicle Safety Act of 1966".

- **Step 1:** Locate the statement "The combined weight of occupants and cargo should never exceed XXX kg or XXX lbs." on your vehicle's Tire and Loading Information placard.
- **Step 2:** Determine the combined weight of the driver and passengers that will be riding in your vehicle.
- **Step 3:** Subtract the combined weight of the driver and passengers from XXX kilograms or XXX lbs.
- **Step 4:** The resulting figure equals the available amount of cargo and luggage load capacity. For example, if the "XXX" amount equals 1400 lbs and there will be five 150-lb passengers in your vehicle, the amount of

available cargo and luggage load capacity is 650 lbs (1400 - 750 (5 x 150) = 650 lbs).

- **Step 5:** Determine the combined weight of luggage and cargo being loaded on the vehicle. That weight may not safely exceed the available cargo and luggage load capacity calculated in step 4.

### Example: steps 1 to 3

The following table shows examples on how to calculate total and cargo load capacities with varying seating configurations and number and size of occupants. The following examples use a load limit of 1500 lbs (680 kg). **This is for illustration purposes only.** Make sure you are using the actual load limit for your vehicle stated on your vehicle's Tire and Loading Information placard (▷ page 303).

The greater the combined weight of the occupants, the lower the maximum luggage load.

#### Step 1

	Example 1	Example 2
<b>Combined maximum weight of occupants and cargo (data from the Tire and Loading Information placard)</b>	1500 lbs (680 kg)	1500 lbs (680 kg)

#### Step 2

	Example 1	Example 2
<b>Number of people in the vehicle (driver and occupants)</b>	1	2
<b>Weight of the occupants</b>	Occupant 1: 175 lbs (80 kg)	Occupant 1: 175 lbs (80 kg) Occupant 2: 195 lbs (88 kg)
<b>Gross weight of all occupants</b>	175 lbs (80 kg)	370 lbs (168 kg)

#### Step 3

	Example 1	Example 2
<b>Permissible load (maximum gross vehicle weight rating from the Tire and Loading Information placard minus the gross weight of all occupants)</b>	1500 lbs (680 kg) - 175 lbs (80 kg) = 1325 lbs (600 kg)	1500 lbs (680 kg) - 370 lbs (168 kg) = 1130 lbs (512 kg)

### Vehicle identification plate

Even if you have calculated the total cargo carefully, you should still make sure that the gross vehicle weight rating and the gross axle weight rating are not exceeded. Details can be found on the vehicle identification plate on the B-pillar on the driver's side of the vehicle (▷ page 303).

**Permissible gross vehicle weight:** the gross weight of the vehicle, all passengers and the load must not exceed the permissible gross vehicle weight.



**Gross Axle Weight Rating (GAWR):** the maximum permissible weight that can be carried by one axle (front or rear axle).

To ensure that your vehicle does not exceed the maximum permissible values (gross vehicle weight and maximum gross axle weight rating), have your loaded vehicle (including driver, occupants and the load) weighed on a suitable vehicle weighbridge.

## All about wheels and tires

### Uniform Tire Quality Grading Standards

#### Overview of Tire Quality Grading Standards

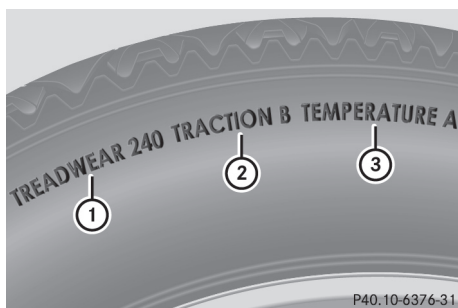

Uniform Tire Quality Grading Standards are U.S. government specifications. Their purpose is to provide drivers with uniform reliable information on tire performance data. Tire manufacturers have to grade tires using three performance factors: ① tread wear grade, ② traction grade and ③ temperature grade. These regulations do not apply to Canada. Nevertheless, all tires sold in North America are provided with the corresponding quality grading markings on the sidewall of the tire. Quality grades can be found, where applicable, on the tire sidewall between tread shoulder and maximum section width.

Example:

- **Treadwear grade:** 200
- **Traction grade:** AA
- **Temperature grade:** A

All passenger car tires must conform to the statutory safety requirements in addition to these grades.

**i** The actual values for tires are vehicle-specific and may deviate from the values in the illustration.

#### Treadwear

The treadwear grade is a comparative rating based on the wear rate of the tire when tested under controlled conditions on a specified U.S. government course. For example, a tire graded 150 would wear one and one-half times as well on the government test track as a tire graded 100.

The relative performance of tires depends upon the actual conditions of their use, however, and may depart significantly from the norm due to variations in driving habits, service practices and differences in road characteristics and climate.

#### Traction

##### WARNING

The traction grade assigned to this tire is based on straight-ahead braking traction tests, and does not include acceleration, cornering, hydroplaning, or peak traction characteristics.

**!** Avoid wheelspin. This can lead to damage to the drive train.

The traction grades – from highest to lowest – are AA, A, B and C. Those grades represent the tire's ability to stop on wet pavement as measured under controlled conditions on specified government test surfaces of asphalt and concrete. A tire marked C may have poor traction performance.

The safe speed on a wet, snow covered or icy road is always lower than on dry road surfaces.

You should pay special attention to road conditions when temperatures are around freezing point.

Mercedes-Benz recommends a minimum tread depth of  $\frac{1}{8}$  in (4 mm) on all four winter tires. Observe the legally required minimum tire tread depth (▷ page 294). Winter tires can reduce the braking distance on snow-covered surfaces in comparison with summer tires. The braking distance is still much further than on



surfaces that are not icy or covered with snow. Take appropriate care when driving.

## Temperature

### WARNING

The temperature grade for this tire is established for a tire that is properly inflated and not overloaded. Excessive speed, underinflation, or excessive loading, either separately or in combination, can cause excessive heat build-up and possible tire failure.

The temperature grades are A (the highest), B, and C, representing the tire's resistance to the generation of heat and its ability to dissipate heat when tested under controlled conditions on a specified indoor laboratory test wheel. Sustained high temperature can cause the material of the tire to degenerate and reduce tire life, and excessive temperature can lead to sudden tire failure. The grade C corresponds to a level of performance which all passenger car tires must meet under the Federal Motor Vehicle Safety Standard No. 109. Grades B and A represent higher levels of performance on the laboratory test wheel than the minimum required by law.

## Tire labeling

### Overview

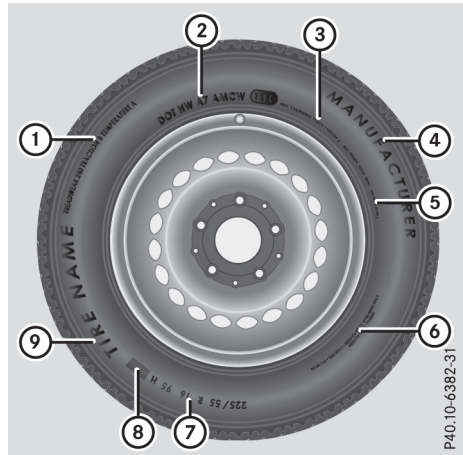

- ① Uniform Tire Quality Grading Standard (▷ page 311)
- ② DOT, Tire Identification Number (▷ page 310)
- ③ Maximum tire load (▷ page 310)
- ④ Maximum tire pressure (▷ page 299)
- ⑤ Manufacturer
- ⑥ Tire material (▷ page 311)
- ⑦ Tire size designation, load-bearing capacity and speed rating (▷ page 307)
- ⑧ Load index (▷ page 309)
- ⑨ Tire name

The markings described above are on the tire in addition to the tire name (sales designation) and the manufacturer's name.

-  Tire data is vehicle-specific and may deviate from the data in the example.

## Tire size designation, load-bearing capacity and speed rating

### WARNING

Exceeding the stated tire load-bearing capacity and the approved maximum speed could lead to tire damage or the tire bursting. There is a risk of accident.

Therefore, only use tire types and sizes approved for your vehicle model. Observe

the tire load rating and speed rating required for your vehicle.

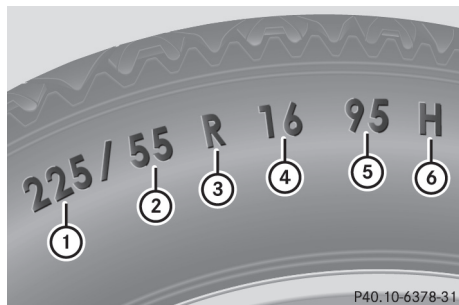

- ① Tire width
- ② Nominal aspect ratio in %
- ③ Tire code
- ④ Rim diameter
- ⑤ Load bearing index
- ⑥ Speed rating

**General:** depending on the manufacturer's standards, the size imprinted in the tire wall may not contain any letters or may contain one letter that precedes the size description.

If there is no letter preceding the size description (as shown above): these are passenger vehicle tires according to European manufacturing standards.

If "P" precedes the size description: these are passenger vehicle tires according to U.S. manufacturing standards.

If "LT" precedes the size description: these are light truck tires according to U.S. manufacturing standards.

If "T" precedes the size description: compact emergency wheels with high tire pressure that are only designed for temporary use in an emergency.

**Tire width:** tire width ① shows the nominal tire width in millimeters.

**Height-width ratio:** aspect ratio ② is the size ratio between the tire height and tire width and is shown in percent. The aspect ratio is calculated by dividing the tire width by the tire height.

**Tire code:** tire code ③ specifies the tire type. "R" represents radial tires; "D" represents diagonal tires; "B" represents diagonal radial tires.

Optionally, tires with a maximum speed of over 149 mph (240 km/h) may have "ZR" in the size description, depending on the manufacturer (e.g. 245/40 ZR 18).

**Rim diameter:** rim diameter ④ is the diameter of the bead seat, not the diameter of the rim flange. The rim diameter is specified in inches (in).

**Load-bearing index:** load-bearing index ⑤ is a numerical code that specifies the maximum load-bearing capacity of a tire.

Do not overload the tires by exceeding the specified load limit. The maximum permissible load can be found on the vehicle's Tire and Loading Information placard on the B-pillar on the driver's side (▷ page 303).

Example:

Load-bearing index 91 indicates a maximum load of 1,356 lb (615 kg) that the tires can bear. For further information on the maximum tire load in kilograms and lbs, see (▷ page 310).

For further information on the load bearing index, see "Load index" (▷ page 309).

**Speed rating:** speed rating ⑥ specifies the approved maximum speed of the tire.

**i** Tire data is vehicle-specific and may deviate from the data in the example.



Regardless of the speed rating, always observe the speed limits. Drive carefully and adapt your driving style to the traffic conditions.

#### Summer tires

Index	Speed rating
Q	up to 100 mph (160 km/h)
R	up to 106 mph (170 km/h)
S	up to 112 mph (180 km/h)
T	up to 118 mph (190 km/h)
H	up to 130 mph (210 km/h)
V	up to 149 mph (240 km/h)
W	up to 168 mph (270 km/h)
Y	up to 186 mph (300 km/h)
ZR...Y	up to 186 mph (300 km/h)

Summer tires	
Index	Speed rating
ZR...(..Y)	over 186 mph (300 km/h)
ZR	over 149 mph (240 km/h)

- Optionally, tires with a maximum speed of over 149 mph (240 km/h) may have "ZR" in the size description, depending on the manufacturer (e.g. 245/40 ZR18).

The service specification is made up of load-bearing index  and speed rating .



- If the size description of your tire includes "ZR" and there are no service specifications, ask the tire manufacturer in order to find out the maximum speed.

If a service specification is available, the maximum speed is limited according to the speed rating in the service specification.

Example: 245/40 ZR18 97 Y. In this example, "97 Y" is the service specification. The letter "Y" represents the speed rating. The maximum speed of the tire is limited to 186 mph (300 km/h).

- The size description for all tires with maximum speeds of over 186 mph (300 km/h) must include "ZR", **and** the service specification must be given in parentheses. Example: 275/40 ZR 18 (99 Y). Speed rating "(Y)" indicates that the maximum speed of the tire is over 186 mph (300 km/h). Ask the tire manufacturer about the maximum speed.

All-weather tires and winter tires	
Index	Speed rating
Q M+S <sup>1</sup>	up to 100 mph (160 km/h)
T M+S <sup>1</sup>	up to 118 mph (190 km/h)
H M+S <sup>1</sup>	up to 130 mph (210 km/h)
V M+S <sup>1</sup>	up to 149 mph (240 km/h)

-  Not all tires with the M+S marking provide the driving characteristics of winter tires. In addition to the M+S marking, winter tires also have the  snowflake symbol on the tire wall. Tires with this marking fulfill the requirements of the Rubber Manufacturers Association (RMA) and the Rubber Association of Canada (RAC) regarding the tire traction on snow. They have been especially developed for driving on snow.

An electronic speed limiter prevents your vehicle from exceeding the following speeds:

- 130 mph (210 km/h):
  - All vehicles (except Mercedes-AMG vehicles)
- 155 mph (250 km/h):
  - Mercedes-AMG SL 63
  - Mercedes-AMG SL 65
- 186 mph (300 km/h):
  - Mercedes-AMG SL 63 (Performance Package)
  - Mercedes-AMG SL 65 increased maximum speed

The speed rating of tires mounted at the factory may be higher than the maximum speed that the electronic speed limiter permits.

Make sure that your tires have the required speed rating, e.g. when buying new tires. The required speed rating for your vehicle can be found in the "tires" section ([▷ page 318](#)).

Further information about reading tire data can be obtained from any qualified specialist workshop.

## Load index



In addition to the load-bearing index, load index  may also be imprinted on the side-

<sup>1</sup> Or M+S  for winter tires.

wall of the tire. You will find this after the letter that identifies the speed rating  
(▷ page 307).

- If no specification is given: no text (as in the example above), represents a standard load (SL) tire
- XL or Extra Load: represents a reinforced tire
- Light Load: represents a light load tire
- C, D, E: represents a load range that depends on the maximum load that the tire can carry at a certain pressure

**i** Tire data is vehicle-specific and may deviate from the data in the example.

### Maximum load rating

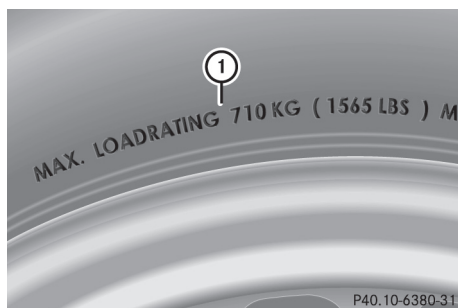

Maximum tire load ① is the maximum permissible weight for which the tire is approved. Do not overload the tires by exceeding the specified load limit. The maximum permissible load can be found on the vehicle's Tire and Loading Information placard on the B-pillar on the driver's side (▷ page 303).

**i** The actual values for tires are vehicle-specific and may deviate from the values in the illustration.

### DOT, Tire Identification Number (TIN)

US tire regulations stipulate that every tire manufacturer or retreader must imprint a TIN in or on the sidewall of each tire produced.

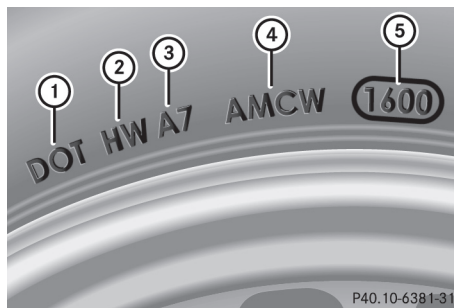

The TIN is a unique identification number. The TIN enables the tire manufacturers or retreaders to inform purchasers of recalls and other safety-relevant matters. It makes it possible for the purchaser to easily identify the affected tires.

The TIN is made up of manufacturer identification code ②, tire size ③, tire type code ④ and manufacturing date ⑤.

**DOT (Department of Transportation):** tire symbol ① marks that the tire complies with the requirements of the U.S. Department of Transportation.

**Manufacturer identification code:** manufacturer identification code ② provides details on the tire manufacturer. New tires have a code with two symbols. Retreaded tires have a code with four symbols.

For further information about retreaded tires, see (▷ page 318).

**Tire size:** identifier ③ describes the tire size.

**Tire type code:** tire type code ④ can be used by the manufacturer as a code to describe specific characteristics of the tire.

**Date of manufacture:** date of manufacture ⑤ provides information about the age of a tire. The first and second positions represent the week of manufacture, starting with "01" for the first calendar week. Positions three and four represent the year of manufacture. For example, a tire that is marked "3214" was manufactured in week 32 in 2014.

**i** Tire data is vehicle-specific and may deviate from the data in the example.

## Tire characteristics

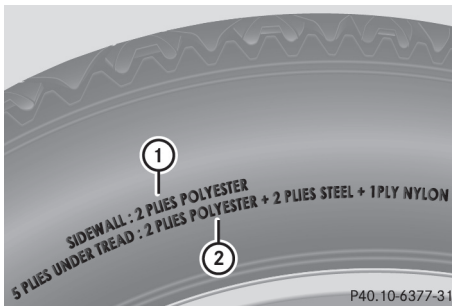

This information describes the type of tire cord and the number of layers in sidewall ① and under tire tread ②.

**i** Tire data is vehicle-specific and may deviate from the data in the example.

## Definition of terms for tires and loading

### Tire ply composition and material used

Describes the number of plies or the number of layers of rubber-coated fabric in the tire tread and sidewall. These are made of steel, nylon, polyester and other materials.

### Bar

Metric unit for tire pressure. 14.5038 pounds per square inch (psi) and 100 kilopascals (kPa) are the equivalent of 1 bar.

### DOT (Department of Transportation)

DOT-marked tires fulfill the requirements of the U S Department of Transportation.

### Normal occupant weight

The number of occupants for which the vehicle is designed multiplied by 68 kilograms (150 lbs).

### Uniform Tire Quality Grading Standards

A uniform standard to grade the quality of tires with regards to tread quality, tire traction and temperature characteristics. The quality grading assessment is made by the manufacturer following specifications from the U.S. government. The ratings are molded into the sidewall of the tire.

## Recommended tire pressures

The recommended tire pressure applies to the tires mounted at the factory.

The Tire and Loading Information placard contains the recommended tire pressures for cold tires on a fully loaded vehicle and for the maximum permissible vehicle speed.

The tire pressure table contains the recommended pressures for cold tires for various operating conditions, i.e. differing load and speed conditions.

## Increased vehicle weight due to optional equipment

The combined weight of all standard and optional equipment available for the vehicle, regardless of whether it is actually installed on the vehicle or not.

### Rim

This is the part of the wheel on which the tire is mounted.

## GAWR (Gross Axle Weight Rating)

The GAWR is the maximum gross axle weight rating. The actual load on an axle must never exceed the gross axle weight rating. The gross axle weight rating can be found on the vehicle identification plate on the B-pillar on the driver's side.

## Speed rating

The speed rating is part of the tire identification. It specifies the speed range for which the tire is approved.

## GVW (Gross Vehicle Weight)

The gross vehicle weight includes the weight of the vehicle including fuel, tools, the spare wheel, accessories installed, occupants, luggage and the drawbar noseweight, if applicable. The gross vehicle weight must not exceed the gross vehicle weight rating GVWR as specified on the vehicle identification plate on the B-pillar on the driver's side.

## GVWR (Gross Vehicle Weight Rating)

The GVWR is the maximum permissible gross weight of a fully loaded vehicle (the weight of the vehicle including all accessories, occupants, fuel, luggage and the drawbar noseweight, if applicable). The gross vehicle weight rating is specified on the vehicle identification plate on the B-pillar on the driver's side.

### Maximum loaded vehicle weight

The maximum weight is the sum of:

- the curb weight of the vehicle
- the weight of the accessories
- the load limit
- the weight of the factory installed optional equipment

### Kilopascal (kPa)

Metric unit for tire pressure. 6.9 kPa corresponds to 1 psi. Another unit for tire pressure is bar. 100 kilopascals (kPa) are the equivalent of 1 bar.

### Load index

In addition to the load-bearing index, the load index may also be imprinted on the sidewall of the tire. This specifies the load-bearing capacity more precisely.

### Curb weight

The weight of a vehicle with standard equipment including the maximum capacity of fuel, oil and coolant. It also includes the air-conditioning system and optional equipment if these are installed in the vehicle, but does not include passengers or luggage.

### Maximum load rating

The maximum load rating is the maximum permissible weight in kilograms or lbs for which a tire is approved.

### Maximum permissible tire pressure

Maximum permissible tire pressure for one tire.

### Maximum load on one tire

Maximum load on one tire. This is calculated by dividing the maximum axle load of one axle by two.

### PSI (pounds per square inch)

A standard unit of measure for tire pressure.

### Aspect ratio

Relationship between tire height and tire width in percent.

### Tire pressure

This is pressure inside the tire applying an outward force to each square inch of the tire's surface. The tire pressure is specified in

pounds per square inch (psi), in kilopascal (kPa) or in bar. The tire pressure should only be corrected when the tires are cold.

### Cold tire pressure

The tires are cold:

- if the vehicle has been parked with the tires out of direct sunlight for at least three hours and
- if the vehicle has not been driven further than 1 mile (1.6 km)

### Tread

The part of the tire that comes into contact with the road.

### Bead

The tire bead ensures that the tire sits securely on the wheel. There are several steel wires in the bead to prevent the tire from coming loose from the wheel rim.

### Sidewall

The part of the tire between the tread and the bead.

### Weight of optional extras

The combined weight of those optional extras that weigh more than the replaced standard parts and more than 2.3 kg (5 lbs). These optional extras, such as high-performance brakes, level control, a roof rack or a high-performance battery, are not included in the curb weight and the weight of the accessories.

### TIN (Tire Identification Number)

This is a unique identifier which can be used by a tire manufacturer to identify tires, for example for a product recall, and thus identify the purchasers. The TIN is made up of the manufacturer's identity code, tire size, tire type code and the manufacturing date.

### Load bearing index

The load bearing index (also load index) is a code that contains the maximum load bearing capacity of a tire.

### Traction

Traction is the result of friction between the tires and the road surface.

### Treadwear indicators

Narrow bars (tread wear bars) that are distributed over the tire tread. If the tire tread is level with the bars, the wear limit of  $\frac{1}{16}$  in (1.6 mm) has been reached.

### Occupant distribution

The distribution of occupants in a vehicle at their designated seating positions.

### Total load limit

Nominal load and luggage load plus 68 kg (150 lbs) multiplied by the number of seats in the vehicle.

## Changing a wheel

### Flat tire

The "Breakdown assistance" section ( $\triangleright$  page 278) contains information and notes on how to deal with a flat tire. Information on driving with MOExtended tires in the event of a flat tire can be found under "MOExtended tires (tires with run-flat characteristics)" ( $\triangleright$  page 278).

### Rotating the wheels

#### WARNING

Rotating the front and rear wheels if the wheels or tires have different dimensions may severely impair the driving characteristics. The service brake or wheel suspension components may also be damaged. There is a risk of an accident.

Rotate front and rear wheels only if the wheels and tires are of the same dimensions.

**!** On vehicles equipped with a tire pressure monitor, electronic components are located in the wheel.

Tire-mounting tools should not be used near the valve. This could damage the electronic components.

Only have tires changed at a qualified specialist workshop.

Always pay attention to the instructions and safety notes when changing a wheel ( $\triangleright$  page 313).

The wear patterns on the front and rear tires differ, depending on the operating conditions. Rotate the wheels before a clear wear pattern has formed on the tires. Front tires typically wear more on the shoulder and rear tires in the center.

On vehicles that have the same size front and rear wheels, you can rotate the wheels according to the intervals in the tire manufacturer's warranty book in your vehicle documents. If no warranty book is available, the tires should be rotated every 3,000 to 6,000 miles (5,000 to 10,000 km). Depending on tire wear, this may be required earlier. Do not change the direction of wheel rotation.

Clean the contact surfaces of the wheel and the brake disc thoroughly every time a wheel is rotated. Check the tire pressure and reactivate the tire pressure monitor if necessary.

### Direction of rotation

Tires with a specified direction of rotation have additional benefits, e.g. if there is a risk of hydroplaning. These advantages can only be gained if the tires are installed corresponding to the direction of rotation.

An arrow on the sidewall of the tire indicates its correct direction of rotation.

### Storing wheels

Store wheels that are not being used in a cool, dry and preferably dark place. Protect the tires from oil, grease, gasoline and diesel.

### Mounting a wheel

#### Preparing the vehicle

- $\blacktriangleright$  Stop the vehicle on solid, non-slippery and level ground.
- $\blacktriangleright$  Unload the vehicle. The jack can only be used when the vehicle is unladen.
- $\blacktriangleright$  Apply the electric parking brake manually.
- $\blacktriangleright$  Bring the front wheels into the straight-ahead position.



- ▶ Shift the transmission to position **P**.
- ▶ Switch off the engine.
- ▶ **Vehicles without KEYLESS-GO:** remove the SmartKey from the ignition lock.
- ▶ **Vehicles with KEYLESS-GO:** open the driver's door.  
The vehicle electronics now have status **0**. This is the same as the SmartKey having been removed.
- ▶ **Vehicles with KEYLESS-GO:** remove the Start/Stop button from the ignition lock (▷ page 126).
- ▶ If included in the vehicle equipment, remove the tire-change tool kit from the vehicle.
- ▶ Safeguard the vehicle against rolling away.

### Securing the vehicle to prevent it from rolling away

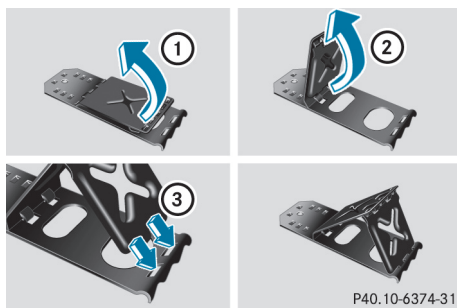

P40.10-6374-31

If your vehicle is equipped with a wheel chock, it can be found in the tire-change tool kit (▷ page 277).

The folding wheel chock is an additional safety measure to prevent the vehicle from rolling away, for example when changing a wheel.

- ▶ Fold both plates upwards ①.
- ▶ Fold out lower plate ②.
- ▶ Guide the lugs on the lower plate fully into the openings in base plate ③.

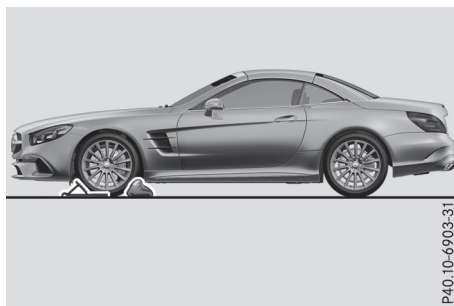

P40.10-6903-31

- ▶ Place chocks or other suitable items under the front and rear of the wheel that is diagonally opposite the wheel you wish to change.

### Raising the vehicle

#### WARNING

If you do not position the jack correctly at the appropriate jacking point of the vehicle, the jack could tip over with the vehicle raised. There is a risk of injury.

Only position the jack at the appropriate jacking point of the vehicle. The base of the jack must be positioned vertically, directly under the jacking point of the vehicle.

- ❗ Only position the jack at the appropriate jacking point of the vehicle. Otherwise, you could damage the vehicle.

Observe the following when raising the vehicle:

- To raise the vehicle, only use the vehicle-specific jack that has been tested and approved by Mercedes-Benz. If used incorrectly, the jack could tip over with the vehicle raised.
- The jack is designed only to raise and hold the vehicle for a short time while a wheel is being changed. It must not be used for performing maintenance work under the vehicle.
- Avoid changing the wheel on uphill and downhill slopes.
- Before raising the vehicle, secure it from rolling away by applying the parking brake and inserting wheel chocks. Do not disengage the parking brake while the vehicle is raised.

- ▶ The jack must be placed on a firm, flat and non-slip surface. On a loose surface, a large, flat, load-bearing underlay must be used. On a slippery surface, a non-slip underlay must be used, e.g. rubber mats.
- ▶ Do not use wooden blocks or similar objects as a jack underlay. Otherwise, the jack will not be able to achieve its load-bearing capacity due to the restricted height.
- ▶ Make sure that the distance between the underside of the tires and the ground does not exceed 1.2 in (3 cm).
- ▶ Never place your hands and feet under the raised vehicle.
- ▶ Do not lie under the vehicle.
- ▶ Do not start the engine when the vehicle is raised.
- ▶ Do not open or close a door or the trunk lid when the vehicle is raised.
- ▶ Make sure that no persons are present in the vehicle when the vehicle is raised.

#### Vehicles with alloy wheels and hub caps:

the wheel bolts are covered by a hub cap. Before you can unscrew the wheel bolts, you must remove the hub cap. Two different variants can be installed.

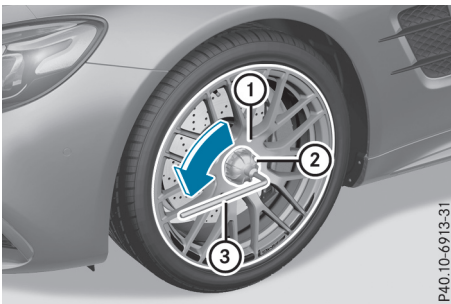

- ▶ **To remove:** take socket ② and lug wrench ③ from the vehicle tool kit (> page 277).
- ▶ Position socket ② on hub cap ①.
- ▶ Position lug wrench ③ on socket ②.
- ▶ Using lug wrench ③, turn hub cap ① counter-clockwise and remove it.
- ▶ **To install:** before installing, check hub cap ① and the wheel area for soiling and clean if necessary.
- ▶ Put hub cap ① in position and turn until it is in the right position.

- ▶ Position socket ② on hub cap ①.
- ▶ Attach lug wrench ③ to socket ② and tighten hub cap ①.

The tightening torque must be **18 lb-ft (25 Nm)**.

- ▶ **Note** that the hub cap should be tightened to the specified torque of **18 lb-ft (25 Nm)**. Mercedes-Benz recommends that you have the hub cap installed at a qualified specialist workshop.

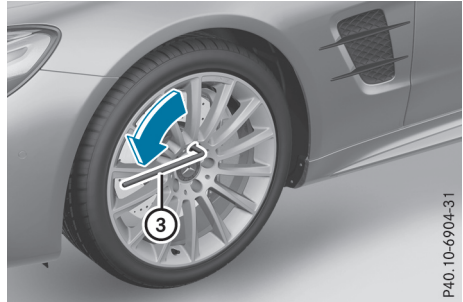

- ▶ Using lug wrench ③, loosen the bolts on the wheel you wish to change by about one full turn. Do not unscrew the bolts completely.

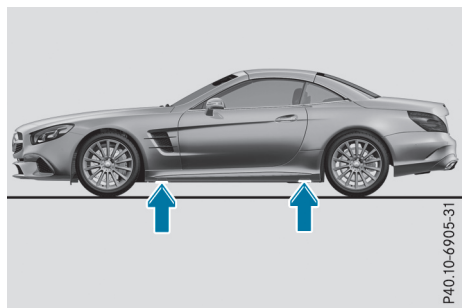

The jacking points are located just behind the front wheel housings and just in front of the rear wheel housings (arrows).

**Mercedes-AMG vehicles and vehicles with AMG equipment:** to protect the vehicle body, the vehicle has covers installed next to the jacking points on the outer sills.

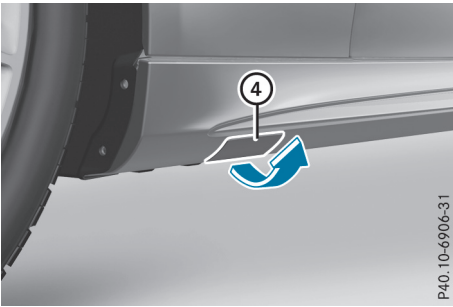

P40.10-6906-31

- ▶ Mercedes-AMG vehicles and vehicles with AMG equipment: fold cover ④ upwards.

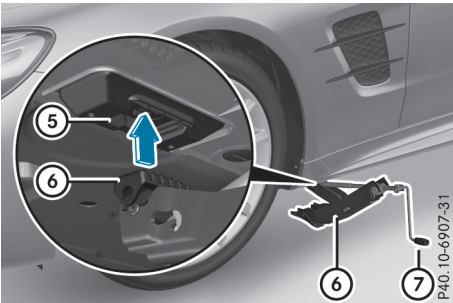

P40.10-6907-31

- ▶ Position jack ⑥ at jacking point ⑤.

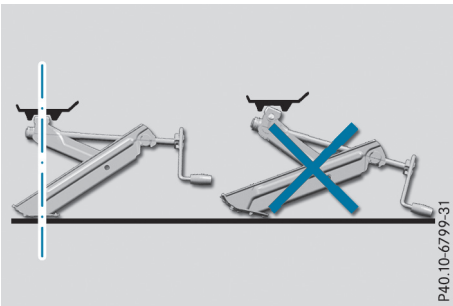

P40.10-6799-31

- ▶ Make sure the foot of the jack is directly beneath the jacking point.
- ▶ Turn crank ⑦ clockwise until jack ⑥ sits completely on jacking point ⑤. The base of the jack must lie evenly on the ground.
- ▶ Turn crank ⑦ until the tire is raised a maximum of 1.2 in (3 cm) from the ground.

## Removing a wheel

**!** Mercedes-AMG vehicles: during removal and repositioning of the wheel, the wheel rim can strike the ceramic-brake disc and damage it. Therefore, you should proceed carefully and get a second person assist to you. Alternatively, you can use a second alignment bolt.

**!** Do not place wheel bolts in sand or on a dirty surface. The bolt and wheel hub threads could otherwise be damaged when you screw them in.

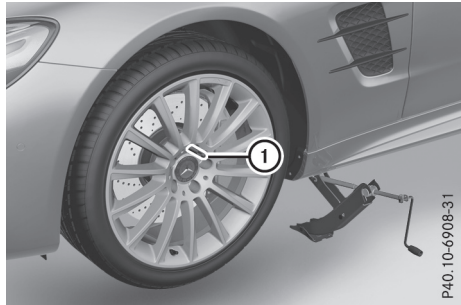

P40.10-6908-31

- ▶ Unscrew the uppermost wheel bolt completely.
- ▶ Screw alignment bolt ① into the thread instead of the wheel bolt.
- ▶ Unscrew the remaining wheel bolts fully.
- ▶ Remove the wheel.

## Mounting a new wheel

### **!** WARNING

Oiled or greased wheel bolts or damaged wheel bolts/hub threads can cause the wheel bolts to come loose. As a result, you could lose a wheel while driving. There is a risk of accident.

Never oil or grease wheel bolts. In the event of damage to the threads, contact a qualified specialist workshop immediately. Have the damaged wheel bolts or hub threads replaced/renewed. Do not continue driving.

### WARNING

If you tighten the wheel bolts or wheel nuts when the vehicle is raised, the jack could tip over. There is a risk of injury.

Only tighten the wheel bolts or wheel nuts when the vehicle is on the ground.

Always pay attention to the instructions and safety notes in the "Changing a wheel" section (▷ page 313).

Only use wheel bolts that have been designed for the wheel and the vehicle. For safety reasons, Mercedes-Benz recommends that you only use wheel bolts which have been approved for Mercedes-Benz vehicles and the respective wheel.

**!** **Mercedes-AMG vehicles:** during removal and repositioning of the wheel, the wheel rim can strike the ceramic-brake disc and damage it. Therefore, you should proceed carefully and get a second person assist to you. Alternatively, you can use a second alignment bolt.

**!** To prevent damage to the paintwork, hold the wheel securely against the wheel hub while screwing in the first wheel bolt.

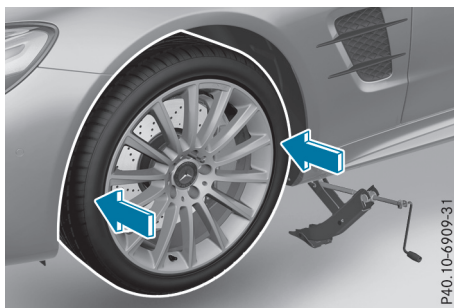

P40.10-6909-31

- ▶ Clean the wheel and wheel hub contact surfaces.
- ▶ Slide the wheel to be mounted onto the alignment bolt and push it on.
- ▶ Tighten the wheel bolts until they are finger-tight.
- ▶ Unscrew the alignment bolt.
- ▶ Tighten the last wheel bolt until it is finger-tight.

## Lowering the vehicle

### WARNING

The wheels could come loose if the wheel bolts or wheel nuts are not tightened to the prescribed tightening torque. There is a risk of an accident.

Ensure that the wheel bolts or wheel nuts are tightened to the prescribed tightening torque.

If you are not sure, do not move the vehicle. Contact a qualified specialist workshop and have the tightening torque checked immediately.

- ▶ Turn the crank of the jack counter-clockwise until the vehicle is once again standing firmly on the ground.
- ▶ Place the jack to one side.

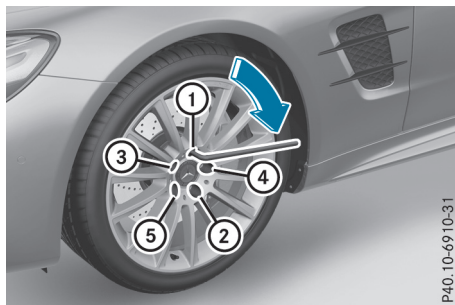

P40.10-6910-31

- ▶ Tighten the wheel bolts evenly in a cross-wise pattern in the sequence indicated (① to ⑤). The specified tightening torque is **96 lb-ft (130 Nm)**.
- ▶ Turn the jack back to its initial position.
- ▶ Stow the jack and the rest of the vehicle tools in the trunk again.
- ▶ **Mercedes-AMG vehicles and vehicles with AMG equipment:** insert the cover into the outer sill.
- ▶ Check the tire pressure of the newly mounted wheel and adjust it if necessary. Observe the recommended tire pressure (▷ page 296).

**Vehicles with a tire pressure control system:** all installed wheels must be equipped with functioning sensors.

When you are driving with the emergency spare wheel mounted, the tire pressure moni-

tor cannot function reliably. Only restart the tire pressure monitor when the defective wheel has been replaced with a new wheel. All mounted wheels must be equipped with functioning sensors for the tire pressure monitor.

### Wheel and tire combinations

You can ask for information regarding permitted wheel/tire combinations at an authorized Mercedes-Benz Center.

**!** For safety reasons, Mercedes-Benz recommends that you only use tires and wheels which have been approved by Mercedes-Benz specifically for your vehicle.

These tires have been specially adapted for use with the control systems, such as ABS or ESP®, and are marked as follows:

- MO = Mercedes-Benz Original
- MOE = Mercedes-Benz Original Extended (tires featuring run-flat characteristics)
- MO1 = Mercedes-Benz Original (only certain AMG tires)

Mercedes-Benz Original Extended tires may only be used on wheels that have been specifically approved by Mercedes-Benz.

Only use tires, wheels or accessories tested and approved by Mercedes-Benz. Certain characteristics, e.g. handling, vehicle noise emissions or fuel consumption, may otherwise be adversely affected. In addition, when driving with a load, tire dimension variations could cause the tires to come into contact with the bodywork and axle components. This could result in damage to the tires or the vehicle.

Mercedes-Benz accepts no liability for damage resulting from the use of tires, wheels or accessories other than those tested and approved.

Information on tires, wheels and approved combinations can be obtained from any qualified specialist workshop.

**!** Retreaded tires are neither tested nor recommended by Mercedes-Benz, since previous damage cannot always be detected on retreaded tires. As a result, Mercedes-Benz cannot guarantee vehicle safety if retreaded tires are mounted. Do not mount used tires

if you have no information about their previous usage.

The recommended pressures for various operating conditions can be found:

- on the Tire and Loading Information placard on the B-pillar on the driver's side
- in the tire pressure table on the fuel filler flap

Observe the notes on recommended tire pressures under various operating conditions (▷ page 296).

Check tire pressures regularly, and only when the tires are cold. Comply with the maintenance recommendations of the tire manufacturer in the vehicle document wallet.

Notes on the vehicle equipment – always equip the vehicle:

- with tires of the same size on a given axle (left and right)
- with the same type of tires at a given time (summer tires, winter tires, MOExtended tires)

Exception: it is permissible to mount a different type or make in the event of a flat tire. Observe the "MOExtended tires (tires with run-flat characteristics)" section (▷ page 278).

Vehicles equipped with MOExtended tires are not equipped with a TIREFIT kit at the factory. It is therefore recommended that you additionally equip your vehicle with a TIREFIT kit if you mount tires that do not feature run-flat characteristics, e.g. winter tires. A TIREFIT kit may be obtained from a qualified specialist workshop.

**Information regarding technical data**

**i** The data stated here specifically refers to a vehicle with standard equipment. Consult an authorized Mercedes-Benz Center for the data for all vehicle variants and trim levels.

**Vehicle electronics**

**Tampering with the engine electronics**

**!** Have the engine electronics and associated parts, such as control units, sensors, actuating components or electric cables serviced only at a qualified specialist workshop. Vehicle components may otherwise wear more quickly and the vehicle's operating permit may be invalidated.

**Installing two-way radios and mobile phones (RF transmitters)**

**⚠ WARNING**

The electromagnetic radiation from two-way radios can interfere with the vehicle electronics if two-way radios are manipulated or retrofitted incorrectly. This could jeopardize the operating safety of the vehicle. There is a risk of an accident.

You should have all work on electrical and electronic components carried out at a qualified specialist workshop.

**⚠ WARNING**

If you incorrectly operate two-way radios in the vehicle, the electromagnetic radiation may interfere with the vehicle electronics, for example if:

- the two-way radio is not connected to an exterior antenna
- the exterior antenna is not correctly mounted or is not low-reflection

This could jeopardize the operating safety of the vehicle. There is a risk of an accident.

Have the low-reflection exterior antenna installed at a qualified specialist workshop. Always connect two-way radios to the low-reflection exterior antenna when operating in the vehicle.

**!** The operating permit may be invalidated if the instructions for installation and use of two-way radios are not observed.

In particular, the following requirements must be complied with:

- only approved wavebands may be used
- observe the maximum permissible output in these wavebands
- only approved antenna positions may be used

Excessive levels of electromagnetic radiation may cause damage to your health and the health of others. Using an exterior antenna takes into account current scientific discussions relating to the possible health hazards that may result from electromagnetic fields.

The following antenna positions may be used if RF transmitters have been properly installed:

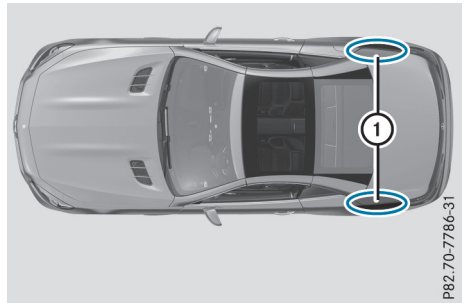

Approved antenna positions

① Rear fenders

**i** On the rear fenders, it is recommended to install the antenna on the side of the vehicle closest to the center of the road.

Use the Technical Specification ISO/TS 21609 when retrofitting RF transmitters (Road Vehicles - EMC guidelines for installation of after-market radio frequency transmitting equipment). Observe the legal requirements for accessory parts.

If your vehicle has installations for two-way radio equipment, use the power supply or antenna connections intended for use with the



basic wiring. Be sure to observe the manufacturer's Supplement when installing.

Deviations with respect to frequency bands, maximum transmission outputs or antenna positions must be approved by Mercedes-Benz.

The maximum transmission output (PEAK) at the base of the antenna must not exceed the following values:

Frequency band	Maximum transmission output
Short wave 3 - 54 MHz	100 W
4 m waveband 74 - 88 MHz	30 W
2 m waveband 144 - 174 MHz	50 W
Trunked radio system/ Tetra 380 - 460 MHz	10 W
70 cm waveband 400 - 460 MHz	35 W
Mobile communications (2G/3G/4G)	10 W

The following can be used in the vehicle without restrictions:

- RF transmitters with a maximum transmission output of up to 100 mW
- RF transmitters with transmitter frequencies in the 380 - 410 MHz waveband and a maximum transmission output of up to 2 W (trunked radio/Tetra)
- Mobile phones (2G/3G/4G)

There is no restriction for antenna positions on the outside of the vehicle for the following frequency bands:

- Trunked radio system/Tetra
- 70 cm waveband
- 2G/3G/4G

## Identification plates

### Vehicle identification plate with vehicle identification number (VIN)

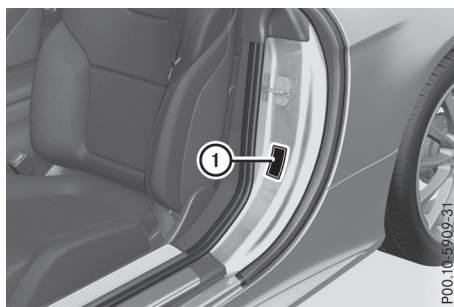

- Open the driver's door.  
You will see vehicle identification plate ①.

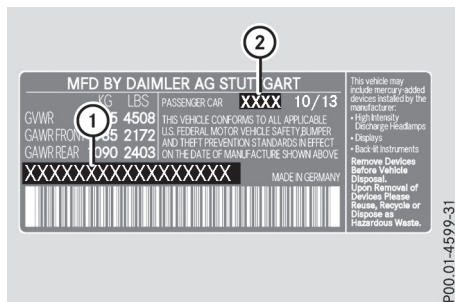

Example: vehicle identification plate (USA only)

- ① VIN  
② Vehicle model

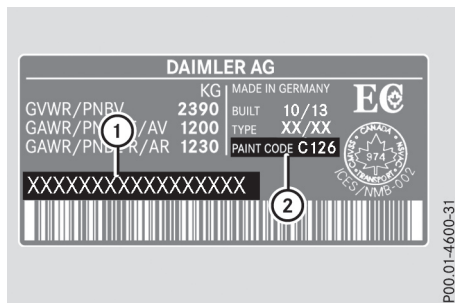

Example: vehicle identification plate (Canada only)

- ① VIN  
② Paint code

**i** The data shown on the vehicle identification plate is used only as an example. This



data is different for every vehicle and can deviate from the data shown here. You can find the data applicable to your vehicle on the vehicle identification plate.

### Vehicle identification number (VIN)

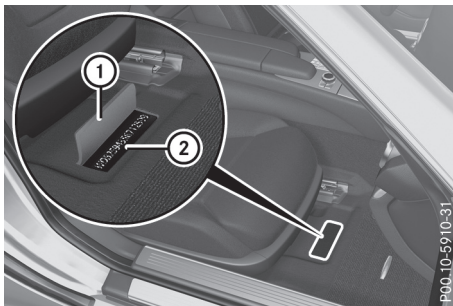

- ▶ Move the front-passenger seat as far back as possible.
- ▶ Fold up floor covering ① in front of the front-passenger seat. You will see VIN ②.

The VIN can also be found in the following locations:

- on the lower edge of the windshield (▷ page 321)
- on the vehicle identification plate (▷ page 320)

### Engine number

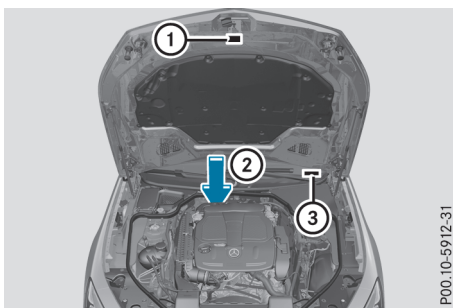

- ① Emission control information plate, including the certification of both federal and Californian emissions standards
- ② Engine number (stamped into the crankcase)
- ③ VIN (on the lower edge of the windshield)

## Service products and filling capacities

### Important safety notes

#### WARNING

Service products may be poisonous and hazardous to health. There is a risk of injury.

Comply with instructions on the use, storage and disposal of service products on the labels of the respective original containers. Always store service products sealed in their original containers. Always keep service products out of the reach of children.

#### Environmental note

Dispose of service products in an environmentally responsible manner.

Service products include the following:

- Fuels
- Lubricants (e.g. engine oil, transmission oil)
- Coolant
- Brake fluid
- Windshield washer fluid
- Climate control system refrigerant

Comply with all valid regulations with respect to handling, storing, and disposing of service fluids.

Components and service products must match. You should therefore only use products that have been tested and approved by Mercedes-Benz.

Information about tested and approved products can be obtained from an authorized Mercedes-Benz Center or on the Internet at <http://bevo.mercedes-benz.com>.

You can identify service products approved by Mercedes-Benz by the following inscriptions on the container:

- MB-Freigabe (e.g. MB-Freigabe 229.51)
- MB-Approval (e.g. MB-Approval 229.51)

Other designations or recommendations indicate a level of quality or a specification in accordance with an MB Sheet Number (e.g. MB 229.51). They have not necessarily been approved by Mercedes-Benz.

Other identifications, for example:

- 0 W-30
- 5 W-30
- 5 W-40

### Fuel

#### Important safety notes

##### WARNING

Fuel is highly flammable. Improper handling of fuel creates a risk of fire and explosion. Avoid fire, open flames, smoking and creating sparks under all circumstances. Switch off the engine and, if applicable, the auxiliary heating before refueling.

##### WARNING

Fuels are toxic and harmful to health. There is a risk of injury.

You must avoid fuels coming into contact with skin, eyes and clothes or being swallowed.

Do not inhale the fuel vapors. Keep children away from fuels.

Keep doors and windows closed during the refueling process.

If you or others come into contact with fuel, observe the following points:

- Immediately rinse the fuel off your skin with soap and water.
- If you get fuel into your eyes, immediately rinse your eyes thoroughly with clean water. Seek medical attention immediately.
- Seek medical attention immediately if fuel has been swallowed. Do not induce vomiting.
- Immediately change out of clothing which has come into contact with fuel.

#### Tank capacity

Model	Total capacity
All models	19.8 US gal (75.0 l)

Model	Of which reserve
Mercedes-AMG vehicles	Approx. 3.7 US gal (14.0 l)
All other models	Approx. 2.4 US gal (9.0 l)

#### Gasoline

##### Fuel grade

 Do not use diesel to refuel vehicles with a gasoline engine. Do not switch on the ignition if you accidentally refuel with the wrong fuel. Otherwise, the fuel will enter the fuel system. Even small amounts of the wrong fuel could result in damage to the fuel system and the engine. Notify a qualified specialist workshop and have the fuel tank and fuel lines drained completely.

 Only refuel using unleaded premium grade gasoline with at least 91 AKI/95 RON.

 E10 fuel contains up to 10% bioethanol. Your vehicle is E10-compatible. You can refuel your vehicle using E10 fuel.

 Only use the fuel recommended. Operating the vehicle with other fuels can lead to damage to the fuel system, engine and exhaust system.

 Do not use the following:

- Gasoline with more than 10% ethanol
- E100 (100% ethanol)
- Gasoline with methanol
- M100 (100% methanol)
- Gasoline with metalliferous additives
- Diesel

Do not mix such fuels with the fuel recommended for your vehicle.

**I** To ensure the longevity and full performance of the engine, only premium-grade unleaded gasoline must be used.

If standard unleaded gasoline is unavailable and you have to refuel with unleaded gasoline of a lower grade, observe the following precautions:

- Only fill the fuel tank to half full with regular unleaded gasoline and fill the rest with premium-grade unleaded gasoline as soon as possible.
- Do not drive at the maximum speed.
- Avoid sudden acceleration and engine speeds over 3,000 rpm.

You will usually find information about the fuel grade on the fuel pump. If you cannot find the label on the fuel pump, ask the gas station staff.

**i** For further information, consult a qualified specialist workshop or visit <http://www.mbusa.com> (USA only).

As a temporary measure, if the recommended fuel is not available, you may also use regular unleaded gasoline with an octane rating of 87 AKI/91 RON. This may reduce engine performance and increase fuel consumption. Avoid driving at full throttle and sudden acceleration. Never refuel using gasoline with a lower AKI.

**i** The fuels you can use in your vehicle may differ from the information in the Operator's Manual depending on the country. The fuels that have been approved for your vehicle can be found on the instruction label on the inside of the fuel filler flap.

Information on refueling (▷ page 145).

### Additives in gasoline

**I** Operating the engine with fuel additives added later can lead to engine failure. Do not mix fuel additives with fuel. This does not include additives for the removal and prevention of residue buildup. Gasoline must only be mixed with additives recommended by Mercedes-Benz. Comply with the instructions for use on the product label. More information about recommended additives can be obtained from any authorized Mercedes-Benz Center.

Mercedes-Benz recommends that you use branded fuels that have additives.

The fuel quality available in some countries may not be sufficient. Residue could build up in the fuel injection system as a result. In such cases, and in consultation with an authorized Mercedes-Benz Center, the fuel may be mixed with the cleaning additive recommended by Mercedes-Benz. You must observe the notes and mixing ratios specified on the container.

## Engine oil

### General notes



**I** Do not use engine oil or an oil filter with specifications deviating from those expressly required for the prescribed service intervals. Do not change the engine oil or oil filter in order to set replacement intervals longer than those prescribed. This could otherwise cause damage to the engine or exhaust gas aftertreatment.

Follow the instructions on the service interval display for changing the engine oil. This could otherwise cause damage to the engine or exhaust gas aftertreatment.

When handling engine oil, observe the important safety notes on service products (▷ page 321).

The engine oils are matched to the performance of Mercedes-Benz engines and service intervals. You should therefore only use engine oils and oil filters that are approved for vehicles with maintenance systems.

For a list of approved engine oils and oil filters, consult an authorized Mercedes-Benz Center. Or visit the website <http://bevo.mercedes-benz.com>.

The table shows which engine oils have been approved for your vehicle.

Model	MB-Freigabe or MB-Approval
All models	229.5

**Mercedes-AMG vehicles:** use only SAE 0W-40 or SAE 5W-40 engine oils.

- MB approval is indicated on the oil containers.

### Filling capacities

The following values refer to an oil change including the oil filter.

Missing values were not available at time of going to print.

Model	Capacity
SL 450	6.9 US qt (6.5 l)
SL 550	8.5 US qt (8.0 l)
Mercedes-AMG SL 63	8.9 US qt (8.5 l)

### Additives

- Do not use any additives in the engine oil. This could damage the engine.

### Brake fluid

#### WARNING

The brake fluid constantly absorbs moisture from the air. This lowers the boiling point of the brake fluid. If the boiling point of the brake fluid is too low, vapor pockets may form in the brake system when the brakes are applied hard. This would impair braking efficiency. There is a risk of an accident.

You should have the brake fluid renewed at the specified intervals.

When handling brake fluid, observe the important safety notes on service products (▷ page 321).

The brake fluid change intervals can be found in the Maintenance Booklet.

Only use brake fluid approved by Mercedes-Benz in accordance with MB-Freigabe or MB-Approval 331.0.

Information about approved brake fluid can be obtained at any qualified specialist workshop or on the Internet at <http://bevo.mercedes-benz.com>.

- Have the brake fluid regularly replaced at a qualified specialist workshop and the replacement confirmed in the Maintenance Booklet.

### Coolant

### Important safety notes

#### WARNING

If antifreeze comes into contact with hot components in the engine compartment, it may ignite. There is a risk of fire and injury. Let the engine cool down before you add antifreeze. Make sure that antifreeze is not spilled next to the filler neck. Thoroughly clean the antifreeze from components before starting the engine.

- Only add coolant that has been premixed with the desired antifreeze protection. You could otherwise damage the engine.

You can find additional notes on the coolant in the following places:

- in the Mercedes-Benz Specifications for Service Products, MB BeVo 310.1
  - on the Internet at <http://bevo.mercedes-benz.com>
  - on the Mercedes-Benz BeVo app
- a qualified specialized workshop

- Always use a suitable coolant mixture, even in countries where high temperatures prevail.

Otherwise, the engine cooling system is not sufficiently protected from corrosion and overheating.

- Have the coolant regularly replaced at a qualified specialist workshop and the replacement confirmed in the Maintenance Booklet.

Comply with the important safety notes for service products when handling coolant (▷ page 321).

The coolant is a mixture of water and anti-freeze/corrosion inhibitor. It is responsible for the following:

- anti-corrosion protection
- antifreeze protection
- raising the boiling point

If the coolant has antifreeze protection down to -35 °F (-37 °C), the boiling point of the coolant during operation is approximately 266 °F (130 °C).

The antifreeze/corrosion inhibitor concentration in the engine cooling system should:

- be at least 50%. This will protect the engine cooling system against freezing down to approximately -35 °F (-37 °C).
- not exceed 55% (antifreeze protection down to -49 °F [-45 °C]). Otherwise, heat will not be dissipated as effectively.

If the vehicle has lost coolant, add equal amounts of water and antifreeze/corrosion inhibitor.

Mercedes-Benz recommends an antifreeze/corrosion inhibitor concentrate in accordance with MB Specifications for Service Products 310.1.

- i** When the vehicle is first delivered, it is filled with a coolant mixture that ensures adequate antifreeze and anti-corrosion protection.
- i** The coolant is checked with every maintenance interval at a qualified specialist workshop.

## Filling capacities

Missing values were not available at time of going to print.

Model	Capacity
SL 450	Approx. 10.8 US qt (10.2 l)
SL 550	Approx. 12.5 US qt (11.8 l)
Mercedes-AMG SL 63	
Mercedes-AMG SL 65	Approx. 10.5 US qt (10 l)

## Windshield washer system

### Important safety notes

#### WARNING

Windshield washer concentrate is highly flammable. If windshield washer concentrate gets onto hot components of the engine or the exhaust system, it can ignite. There is a risk of fire and injury.

Make sure that windshield washer concentrate is not spilled in the vicinity of the filler neck.

**!** Only use washer fluid which is suitable for lamp lenses, e.g. MB SummerFit or MB WinterFit. Unsuitable washer fluid may damage the lamp lenses of the headlamps.

**!** Only MB SummerFit and MB WinterFit washer fluid should be mixed together. The spray nozzles may otherwise become blocked.

Do not use distilled or de-ionized water. Otherwise, the level sensor may give a false reading.

When handling washer fluid, observe the important safety notes on service products (> page 321).

At temperatures above freezing:

- ▶ Fill the washer fluid reservoir with a mixture of water and windshield washer fluid, e.g. MB SummerFit.
- ▶ Add 1 part MB SummerFit to 100 parts water.

At temperatures below freezing:

- ▶ Fill the washer fluid reservoir with a mixture of water and washer fluid, e.g. MB WinterFit. For the correct mixing ratio refer to the information on the antifreeze reservoir.

**i** Add windshield washer fluid, e.g. MB SummerFit or MB WinterFit, to the washer fluid all year round.

## Climate control system refrigerant

### Important safety notes

The climate control system of your vehicle is filled with refrigerant R-134a.

The instruction label regarding the refrigerant type used can be found on the radiator cross member.

**!** Only the refrigerant R-134a and the PAG oil approved by Mercedes-Benz may be used. The approved PAG oil may not be mixed with any other PAG oil that is not approved for R-134a refrigerant. Otherwise, the climate control system may be damaged.

Service work, such as refilling with refrigerant or replacing component parts, may only be carried out by a qualified specialist workshop. All applicable regulations, as well as SAE standard J639, must be adhered to.

Always have work on the climate control system carried out at a qualified specialist workshop.

### Refrigerant instruction label

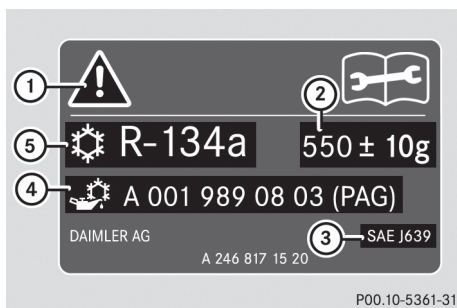

Example: refrigerant instruction label

- ① Symbol
- ② Refrigerant filling capacity
- ③ Applicable standards
- ④ PAG oil part number
- ⑤ Type of refrigerant

Symbols ① advise you about:

- Possible dangers
- Having service work carried out at a qualified specialist workshop

## Filling capacities

Model	Refrigerant
All models	19.4 ± 0.4 oz (550 ± 10 g)

Model	PAG oil
All models	4.2 oz (120 g)

## Vehicle data

### General notes

Please note that for the specified vehicle data:

- the heights specified may vary as a result of
  - tires
  - load
  - condition of the suspension
  - optional equipment
- optional equipment reduces the maximum payload

## Dimensions and weights

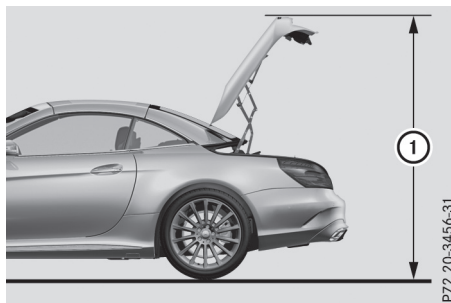

Model	① Opening height
Mercedes-AMG vehicles	75.6 in - 76.1 in (1920 mm - 1934 mm)
All other models	75.7 in (1923 mm)

Missing values were not available at time of going to print.

Mercedes-AMG vehicles	
Vehicle length	182.7 in (4640 mm)
Vehicle length when opening/closing the roof	
Vehicle width including exterior mirrors	82.6 in (2099 mm)
Vehicle height	51.2 in - 51.5 in (1300 mm - 1308 mm)
Vehicle height when opening/closing the roof	66.1 in - 66.6 in (1679 mm - 1691 mm)
Wheelbase	101.7 in (2584 mm)
Turning radius	

All other models	
Vehicle length, SL 450	182.3 in (4631 mm)
Vehicle length, SL 550	182.3 in (4631 mm)
Vehicle length when opening/closing the roof, SL 450	188.5 in (4787 mm)
Vehicle length when opening/closing the roof, SL 550	188.5 in (4787 mm)
Vehicle width including exterior mirrors	82.6 in (2099 mm)
Vehicle height	51.8 in (1315 mm)
Vehicle height when opening/closing the roof	66.8 in (1696 mm)
Wheelbase	101.8 in (2585 mm)
Turning radius	36.2 ft (11.04 m)



